

PLC Gateway BL102



BL102 User Manual

Version: V1.1

Date: 2022-9-29

Shenzhen Beilai Technology Co.,Ltd

Website: <https://www.bliiot.com>

Preface

Thanks for choosing BLIIoT PLC Modbus IOT Gateway BL102. Reading this manual with full attention will help you quickly learn device functions and operation methods.

Copyright

This user manual is owned by Beilai Technology Co., Ltd. No one is authorized to copy, distribute or forward any part of this document without written approval of Beilai Technology. Any violation will be subject to legal liability.

Disclaimer

This document is designed for assisting user to better understand the device. As the described device BL102 is under continuous improvement, this manual may be updated or revised from time to time without prior notice. This PLC Gateway is mainly used for industrial data transmission over Ethernet or 4G network. Please follow the instructions in the manual. Any damages caused by wrong operation will be beyond warranty.

Revision History

Revision Date	Version	Description	Owner
July 8, 2021	V1.0	Initial Release	HYQ
June 8, 2022	V1.1	Add DL/T645, thingsboard and openVPN functions, optimize the collection of Siemens PLC, Mitsubishi PLC, Omron PLC and Delta PLC.	HYQ

Content

1 Gateway Introduction	8
1.1 General Description	8
1.2 Application Diagram	9
1.3 Packing List	9
1.4 Product Features	12
1.5 Technical Specification	13
1.6 Model Selection Table	15
1.7 PLC protocols Supported	15
2 Hardware Introduction	18
2.1 Dimension	18
2.2 Power Supply Interface	19
2.3 SIM & SD Card Slots	19
2.4 Debugging & Upgrading Interface	19
2.5 Gateway Grounding	19
2.6 4G Antenna Interface	20
2.7 LED Indicator	20
2.8 Reset Button	20
2.9 COM Port & Power Output Interface	21
2.10 WAN & LAN Ports	21
3 Gateway Mounting	22
3.1 Wall-Mounting (Optional)	22
3.2 DIN Rail Mounting(Optional)	23
4 Configuration Software Introduction	23
4.1 Login to Configuration Software	23
4.1.1 Open Configuration Software	24
4.1.2 Search for Devices	24
4.1.3 Connecting Gateway	25
4.2 Configuration Software Introduction	26
4.2.1 System	26

4.2.2 Advanced Settings	27
4.2.3 COM Port Configuration	28
4.2.3.1 COM Port Attribute Configuration	28
4.2.3.2 Add COM Port Connected Device	30
4.2.3.3 Add COM Port Device Datapoint	31
4.2.4 LAN Port Configuration	33
4.2.4.1 LAN Port Attribute Configuration	33
4.2.4.2 Add Device to LAN Port	34
4.2.4.3 Add LAN Port Device Datapoint	36
4.2.5 WAN Port Configuration	36
4.2.5.1 WAN Port Attribute Configuration	36
4.2.5.2 Add Device to WAN Port	37
4.2.5.3 Add WAN Port Device Datapoint	39
4.2.6 4G Network Introduction	39
4.2.7 OpenVPN Introduction	40
4.2.8 Alarms and Events Configuration	41
4.2.8.1 Alarm Point Configuration	42
4.2.8.2 Alarm Event Configuration	43
4.2.9 Task Plan Configuration	44
4.2.10 Data Service	46
4.2.10.1 Transparent Transmission	46
4.2.10.2 Modbus RTU to Modbus TCP	48
4.2.10.3 Modbus TCP Server	49
4.2.10.4 OPC UA	50
4.2.11 Cloud Platform	51
4.2.11.1 MQTT Client	51
4.2.11.2 MQTT Client II	53
4.2.11.3 Alibaba Cloud	54
4.2.11.4 HUAWEI Cloud	56
4.2.11.5 AWS Cloud	59
4.2.11.6 King Pigeon Cloud via MQTT	61

4.2.11.7 King Pigeon Cloud via Modbus	64
5 Gateway BL102 Application Example	66
5.1 Add Modbus Device	66
5.1.1 Connect M140T & S475 to BL102	67
5.1.2 COM Port Configuration	67
5.1.2.1 COM1 Port Configuration	67
5.1.2.2 Add COM Port Device M140T	68
5.1.2.3 Add COM Port Device M140T Datapoint	69
5.1.3 Ethernet Port Configuration	70
5.1.3.1 LAN Port Configuration	70
5.1.3.2 Add LAN Port Device S475	71
5.1.3.3 Add LAN Port Device S475 Datapoint	72
5.1.4 Uploading Data to Various Clouds	73
5.2 Collecting PLC Data	73
5.2.1 Configuring Collecting Siemens PLC Data	73
5.2.1.1 Add Siemens PLC to COM Port	73
5.2.1.1.1 COM Port Configuration	74
5.2.1.1.2 Add COM Port Device S7-200	75
5.2.1.1.3 Add COM Port Device S7-200 Datapoint	75
5.2.1.2 Adding Siemens PLC via Ethernet Port	77
5.2.1.2.1 LAN Port Configuration	77
5.2.1.2.2 Add LAN Port Siemens PLC S7-200SMART	78
5.2.1.2.3 Add LAN Port Siemens PLC S7-200SMART Datapoint	78
5.2.2 Configuring Collecting Mitsubishi PLC Data	80
5.2.2.1 Add Mitsubishi PLC to COM Port	80
5.2.2.1.1 COM1 Configuration	80
5.2.2.1.3 Add COM Port Mitsubishi PLC FX3U Datapoint	81
5.2.2.2 Adding Mitsubishi PLC to Ethernet Port	83
5.2.2.2.1 WAN Port Configuration	83
5.2.2.2.2 Add Mitsubishi FX5U to WAN Port	84
5.2.2.2.3 Add Mitsubishi FX5U Data Point	85

5.2.2.3 Uploading Data to Various Clouds	86
5.2.3 Collecting OMRON PLC Data	86
5.2.3.1 Add OMRON PLC to COM Port	86
5.2.3.1.1 COM Port Configuration	86
5.2.3.1.2 Add CP1L to COM Port	88
5.2.3.1.3 Add CP1L Data Point	88
5.2.3.2 Add OMRON PLC via Ethernet Port	90
5.2.3.2.1 LAN Port Configuration	90
5.2.3.2.2 Add OMRON PLC CP1L-EL to LAN Port	91
5.2.3.2.3 Add LAN Port OMRON PLC CP1L-EL Datapoint	91
5.2.3.3 Uploading Data to Various Clouds	93
5.2.4 Collecting Delta PLC Data	93
5.2.4.1 Add Delta PLC to COM Port	93
5.2.4.1.1 COM Port Configuration	93
5.2.4.1.2 Add DVP-12SA2 to COM Port	94
5.2.4.1.3 Add DVP-12SA2 Data Point	94
5.2.4.2 Add Delta PLC to Ethernet Port	96
5.2.4.3 Uploading Data to Various Clouds	96
5.3 Collecting Watt-Hour Meter Data	96
5.3.1 Adding Watt-Hour Meter to COM Port	96
5.3.1.1 COM Port Configuration	96
5.3.1.2 Add Watt-hour Meter to COM Port	96
5.3.1.3 Add COM Port Watt-hour Meter Datapoint	96
5.3.2 Add Wat-hour Meter to Ethernet Port	96
5.3.3 Uploading Data to Various Clouds	96
5.4 Configuration of Uploading Data to Various Clouds	97
5.4.1 Modbus TCP Server Configuration	98
5.4.1.1 View and Send Command with KingView	98
5.4.2 OPC UA Configuration	101
5.4.2.1 View and Send Command with UaExpert	102
5.4.3 MQTT Client Configuration	104

5.4.3.1 View and Send Command with MQTT.fx.....	106
5.4.4 Alibaba Cloud Configuration.....	109
5.4.4.1 View and Send Command in Alibaba Cloud.....	111
5.4.5 HUAWEI Cloud Configuration.....	114
5.4.5.1 View and Send Command in HUAWEI Cloud.....	116
5.4.6 AWS Cloud Configuration.....	119
5.4.6.1 View and Send Command in AWS Cloud.....	120
5.4.7 King Pigeon Cloud via Modbus.....	122
5.4.7.1 View Data in King Pigeon Cloud via Modbus.....	122
5.4.8 King Pigeon Cloud via MQTT.....	126
5.4.8.1 View Data in King Pigeon Cloud via MQTT.....	127
5.4.9 King Pigeon Cloud MQTT Data Format.....	130
6 Firmware Upgrading.....	133
7 Warranty Terms.....	134
8 Technical Support.....	134

1 Gateway Introduction

1.1 General Description

BL102 is a gateway that converts various PLC protocols, Modbus RTU, Modbus TCP, DL/T645 and other protocols to Modbus TCP, OPC UA, MQTT, Huawei Cloud IoT, Amazon Cloud IoT, Alibaba Cloud IoT, ThingsBoard, King Pigeon Cloud and other protocols.

BL102 downlink support: Various PLC protocols, Modbus RTU Master, Modbus TCP Master, DL/T645 and other protocols.

BL102 uplink supports: Modbus TCP, MQTT, OPC UA, and other protocols.

It has built-in cloud drivers such as Huawei Cloud IoT, Alibaba Cloud IoT, AWS IoT, ThingsBoard, Sparkplug B, King Pigeon Cloud, Users can quickly connect many different industrial equipment to cloud platforms. Devices can be online in various cloud platforms and on-premises computer simultaneously.

BL102 adopts embedded ARM MCU, and developed based on Linux OS system which has high stability. One RS485(optional RS232) serial port input, two power inputs, one power output, two Ethernet ports (WAN ports and LAN ports), two USB interfaces, and SIM cards and SD cards slot. Access to the Internet via 4G network or Ethernet that has the characteristics of fast speed and low latency data transmission.

BL102 supports TLS SSL encryption to ensure data security.

BL102 supports remote management or configuration through OpenVPN.

BL102 supports the routing function and the data collection of cascaded switches which is more convenient to collect data from more industrial equipment.

BL102 integrates the humanized configuration interface inherited by Beilai Technology, as well as remote configuration, remote firmware upgrade and other functions. Easy for users to finish settings.

BL102 adopts fastening structure, redundant power supply design and standard DIN35 rail installation.

1.2 Application Diagram

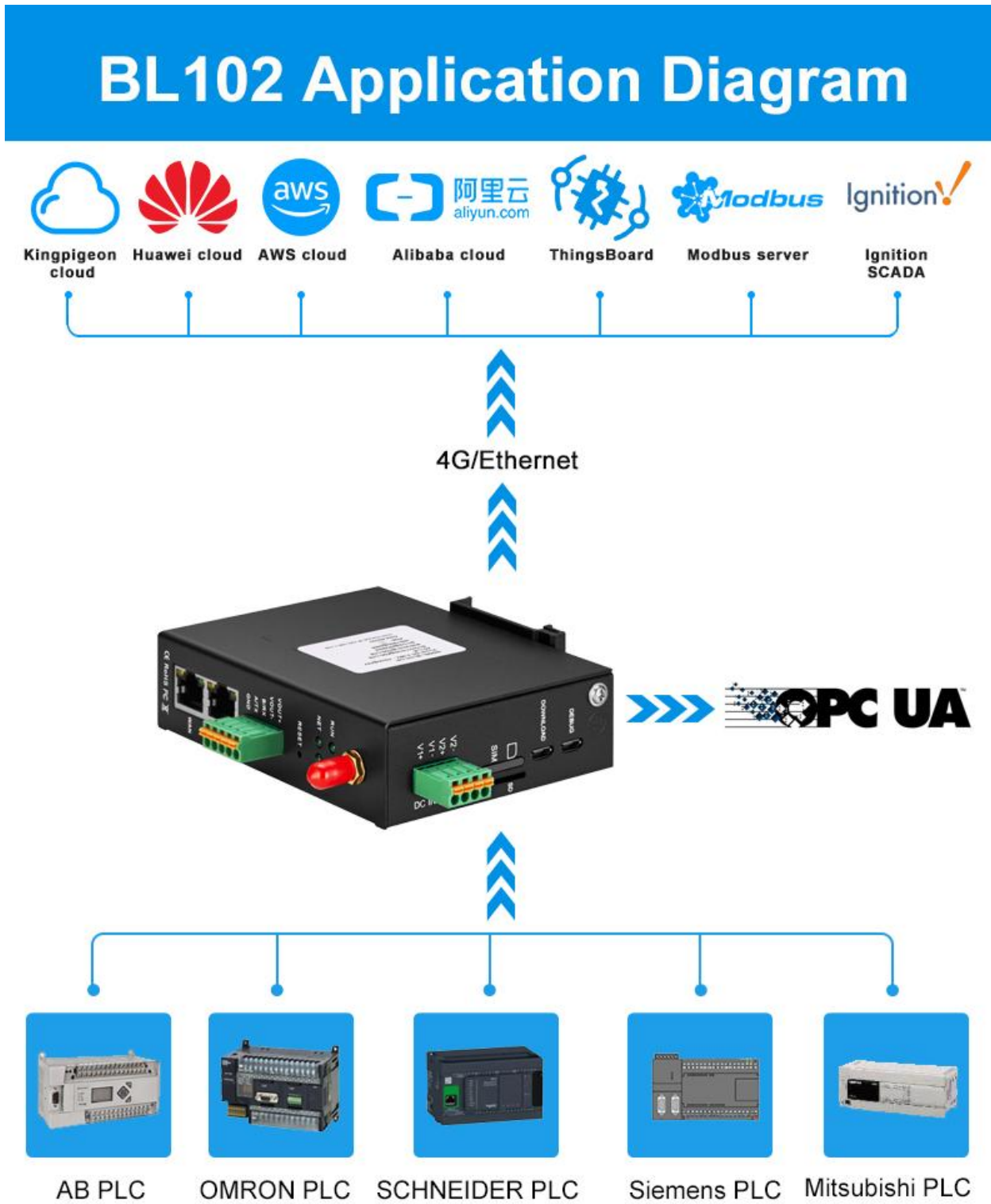

1.3 Packing List

Before using Gateway BL102, please make sure below parts are included in the package:

(Below pictures are for reference only. If any discrepancy, please follow real products)

- 1x Gateway BL102



- 1x 4PIN 3.5mm Wiring Terminal for power input



- 1x 5PIN 3.5mm Wiring Terminal for RS485 or RS232 power output



- 1 x 4G SMA Cellular Network Antenna



- 2 x Wall-Mount Clip Kit(Optional accessories)

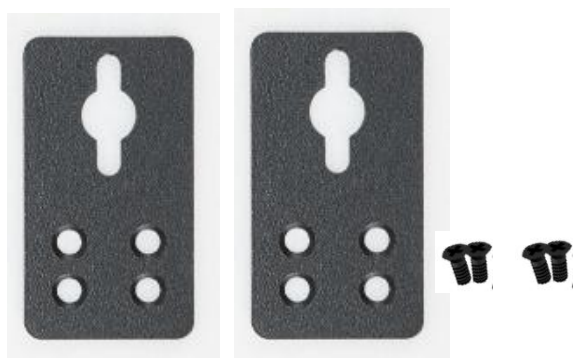

- 1 x DIN-Rail Mount Clip Kit(Optional accessories)



- 1 x User Manual (PDF soft copy)
(Note: Scan QR code to download the user manual)

- 1 x SIM Card Picking Pin



- 1 x Product Qualification Certificate



- 1 x Warranty Card

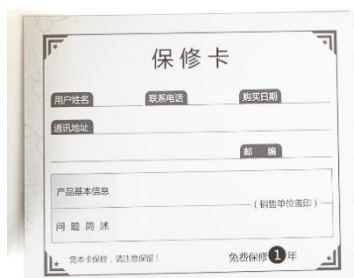

Note: if any items are missing, please contact BLIIoT sales representative.

1.4 Product Features

Downlink supports: Various PLC protocols, Modbus RTU Master, Modbus TCP Master, DL/T645 and other protocols;

Uplink supports: Modbus TCP, MQTT, OPC UA, HUAWEI Cloud, Alibaba Cloud, AWS, ThingsBoard Cloud, [Sparkplug B](#), King Pigeon Cloud, etc.

- DC 9-36V wide power voltage input with wiring terminal. There are 2 channels of power input redundancy design with inverse connection protection. Either channel can be selected.
- 1 power output, output voltage is equal to input voltage.
- 1 RS485(optional RS232) serial port input
- Serial port baud rate 1200bps-115200bps; stop bit supports 1, 2 bits; data bit supports 7,8 bits; parity bit supports None, Odd, Even.
- 2 RJ45 ports for Ethernet connection, 1 WAN and 1 LAN. Data can be collected from devices connected to WAN and LAN port or cascaded switch devices. Network link and rate indicators are available. Built-in isolation transformer with up to 2KV electromagnetic insulation.
- Support POE PD (Powered Device) for saving wiring cost (Optional function).
- Support TSL\SSL data encryption for security.
- Support routing function to provide network for other devices.
- Support 4G cellular network and APN setting. Ethernet network will be used if it's available. It will shift to 4G network automatically if Ethernet is not available.
- Support remote management or configuration through OpenVPN tunnels
- Support sending configuration files and change the configuration remotely through MQTT
- Support Modbus RTU to Modbus TCP and transparent transmission.
- Support RESET button for returning to factory settings (Long press the button until RUN indicator off with power) to avoid wrong parameter settings.
- Support software and hardware watchdog for high reliability.
- Metal case with IP30 protection grade. Metal case and system are safely isolated, especially suitable for industrial site applications.
- Compact device size: 30mm*83mm*110mm, support wall-mounting and DIN-Rail mounting.

1.5 Technical Specification

Item	Parameter	Description
System	Processor	ARM9, clock speed 300Mhz
	Storage	128MB(scalable to 1G)
	Flash Memory	64MB
Power Source	Input Voltage	DC 9~36V
	Power Consumption	Normal: 85mA@12V, max 117mA@12V
	Wiring	Support Inverse Connection Protection
Ethernet Port	Interface Spec	2 x RJ45, 10/100Mbps, adaptive MDI/MDIX
	Port Protection	ESD ± 16 kV (contact), ± 18 kV (air), EFT 40A (5/50ns), Lightening 6A (8/20 μ s)
Serial Port	Serial Port Qty	1 x RS485/ optional RS232
	Baud Rate	1200bps-115200bps
	Data Bit	7, 8
	Parity Bit	None, Even, Odd
	Stop Bit	1, 2
	Port Protection	ESD ± 8 kV (contact), ± 15 kV (air) EFT 2KV, 40A (5/50ns)
Power Output	Output Voltage	1 channel DC 9~36 V power output (Output voltage is equal to input voltage)
SIM Card	Qty	1 SIM Card Slot
	Spec	Drawer type slot, support 1.8V/3V SIM/UIM card (NANO)
	Protection	Built-in 15KV ESD Protection
SD Card	Qty	1 SD Card slot reserved for future development
USB Port	Qty	1*program downloading+1* program debugging
	Spec	Micro USB OTG
	Protection	Over Current Protection
4G Network (Optional)	Antenna Qty	1
	Antenna Type	SMA Hole Type
	L-E version	GSM/EDGE:900,1800MHz WCDMA:B1,B5,B8 FDD-LTE:B1,B3,B5,B7,B8,B20 TDD-LTE:B38,B40,B41
	L-CE version	GSM/EDGE:900,1800MHz

		WCDMA:B1,B8 TD-SCDMA:B34,B39 FDD-LTE:B1,B3,B8 TDD-LTE:B38,B39,B40,B41
	L-A version	WCDMA:B2,B4,B5 FDD-LTE:B2,B4,B12
	L-AU version	GSM/EDGE:850,900,1800MHz WCDMA:B1,B2,B5,B8 FDD-LTE:B1,B3,B4,B5,B7,B8,B28 TDD-LTE:B40
	L-AF version	WCDMA:B2,B4,B5 FDD-LTE:B2,B4,B5,B12,B13,B14,B66,B71
	CAT-1 version	GSM:900,1800 FDD-LTE:B1,B3,B5,B8 TDD-LTE:B34,B38,B39,B40,B41
Indicator	RUN	Steady light if device is powered on Flickering if device is running Off if device is not running
	NET	Flickering if communication is over Ethernet network Steady light if communication is over 4G network Off if no data communication
	TXD	Flickering if device is transmitting data Off if there's no data transmitting
	RXD	Flickering if device is receiving data Off if there is no data receiving
Software Parameter	Internet Protocol	IPV4, TCP/UDP, DHCP, DNS, etc
	IP Retrieving	Static IP / DHCP
	Transmission	Support Transparent Transmission
	DNS	Support Domain Name Resolution
	Configuration	PC configuration software, support WIN XP, WIN 7, WIN 8 and WIN 10
	Internet Cache Size	Transmitting: 8Kbyte; Receiving: 8Kbyte
	Login Package	Support custom login package
	Heartbeat Package	Support custom heartbeat package
Safety	MTBF	≥100,000 hours
Certification	EMC	EN 55022: 2006/A1: 2007 (CE &RE) Class B

		IEC 61000-4-2 (ESD) Level 4
		IEC 61000-4-3 (RS) Level 4
		IEC 61000-4-4 (EFT) Level 4
		IEC 61000-4-5 (Surge)Level 3
		IEC 61000-4-6 (CS)Level 4
		IEC 61000-4-8 (M/S) Level 4
	Other	CE, FCC
Environment	Working	-40~80℃, 5~95% RH
	Storage	-40~85℃, 5~95% RH
Others	Case	Metal Case
	Size	30mm×83mm×110mm(L*W*H)
	Protection Grade	IP30
	Net Weight	291.2g
	Mounting	Wall-Mounting, DIN-Rail Mounting

1.6 Model Selection Table

Model No.	WAN	LAN	COM (Default is RS485 Optional RS232)	OPC-UA	4G	OpenVPN	POE PD (Powered Device)
BL102	1	1	1	X	√	×	Optional
BL102E	1	1	1	X	X	×	Optional
BL102UA	1	1	1	√	X	×	Optional
BL102Pro	1	1	1	√	√	√	Optional

1.7 PLC protocols Supported

Downlink supported protocols

Brand	Connecting Interface	Protocol	Testing Status
Modbus	COM Port	Standard Modbus RTU	OK
	Ethernet Port	Standard Modbus TCP/IP	OK
Siemens	COM Port	S7-200 full series PLC	OK
		S7-200SMART full series PLC	OK
	Ethernet Port	S7-200SMART full series PLC	OK
		S7-300 full series PLC	OK
		S7-400 full series PLC	OK

		S7-1200 full series PLC	OK
		S7-1500 full series PLC	OK
Mitsubishi	COM Port	FX1S series, FX2N series FX3S series, FX3U series, Expansion board RS232/485BD	OK
	Ethernet Port	Q series(Q03UDE, Q04UDEH, Q06UDEH, Q10UDEH, Q13UDEH, Q20UDEH, Q26UDEH, Q002UD), L serials(L02, L26-BT), FX5U serials	OK
OMRON	COM Port	CJ/CS/CP/CP1H/CP1L serials	OK
	Ethernet Port	CJ/CS/CP/CP1H/CP1L series	OK
Delta	COM Port	DVP series	OK
FATEK	COM Port	FB series	Ongoing
AB	COM Port	DF1 protocol	Ongoing
Schneider	COM Port	full series	Ongoing
	Ethernet Port	full series	Ongoing
XINJIE	COM Port	XCseries	Ongoing
ABB		AC500series	To be started
Emerson			To be started
Hitachi			To be started
Keyence		KVseries	To be started
KOYO		Kseries	To be started
LG			To be started
VIGOR			To be started
Smart Meter	COM Port	DLT645-2007	OK
	Ethernet Port	IEC101, IEC104	Ongoing

If your PLC is included in above table, please contact BLIIoT after-sale service team.

Uplink Supported Protocols

Protocol	Description
Transparent Transmission	Only support COM port transparent transmission
Modbus RTU to Modbus TCP	Yes, support Modbus RTU to Modbus TCP

Modbus TCP	Can only be server with Ethernet port communication
OPC UA	Can only be server with Ethernet port communication
Custom MQTT	Currently only support “King Pigeon”, “thingsboard”, “Sparkplug B” JSON data format, others are under development
HUAWEI Cloud	Support Private Key /Certificate connection to HUAWEI Cloud
AWS Cloud	Yes, support AWS Cloud
Alibaba Cloud	Support Private Key /Certificate connection to Alibaba Cloud
ThingsBoard Cloud	Yes, support ThingsBoard cloud, Select ThingsBoard data module in custom MQTT
Modbus RTU	Yes, support Modbus RTU, configure it in King Pigeon Modbus
King Pigeon Cloud	Yes, support King Pigeon Cloud, configure Modbus RTU/MQTT

2 Hardware Introduction

2.1 Dimension

Unit: mm



Bottom view

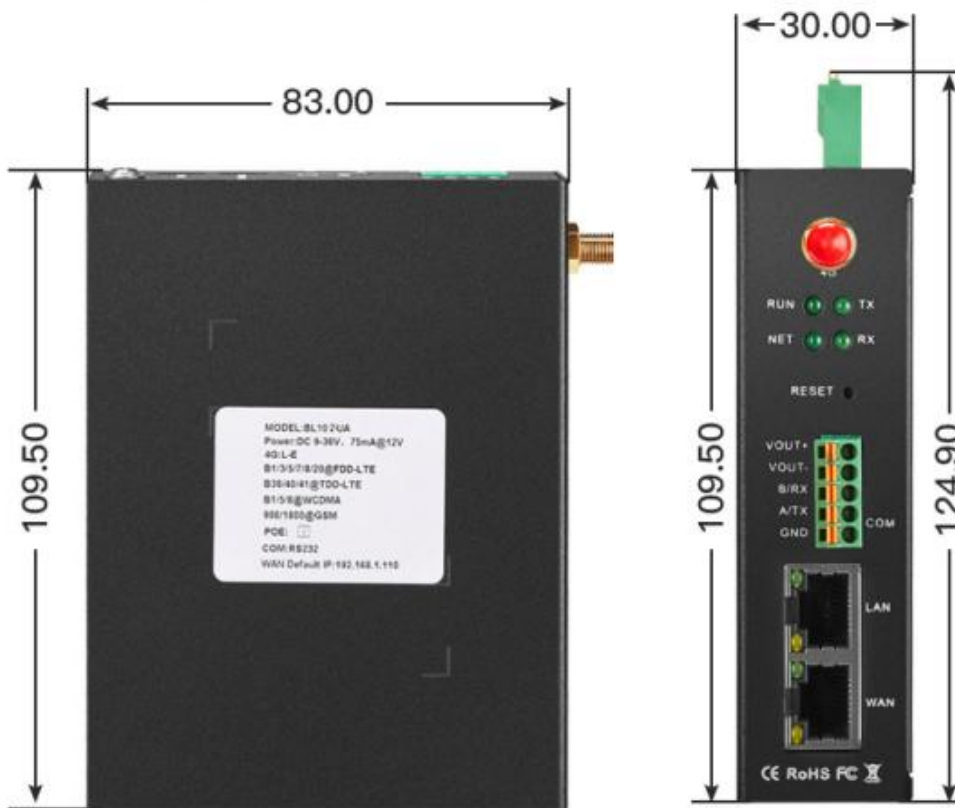

Side view

Main view

2.2 Power Supply Interface



2 optional channels of power input support DC 9~36V voltage with inverse connection protection.

2.3 SIM & SD Card Slots



Make sure device is powered off before inserting or removing SIM card. Insert SIM card Picking PIN into the hole with tiny force to eject out the card tray.

Note: Place the device flat like above picture if inserting or removing SIM card.

2.4 Debugging & Upgrading Interface

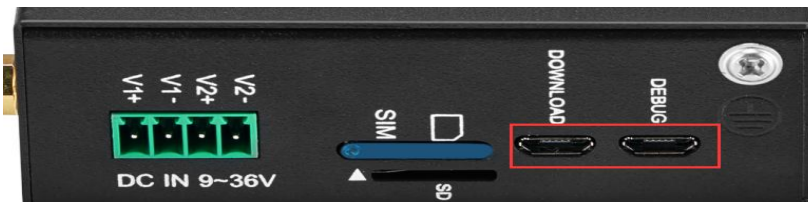

DEBUG is the interface for debugging, DOWNLOAD is the interface for upgrading.

2.5 Gateway Grounding

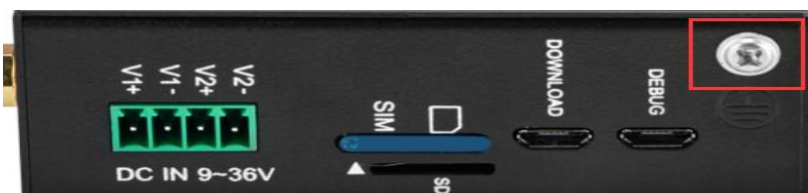

Before connecting the device, please do equipment grounding with grounding screw to prevent electromagnetic interference

2.6 4G Antenna Interface

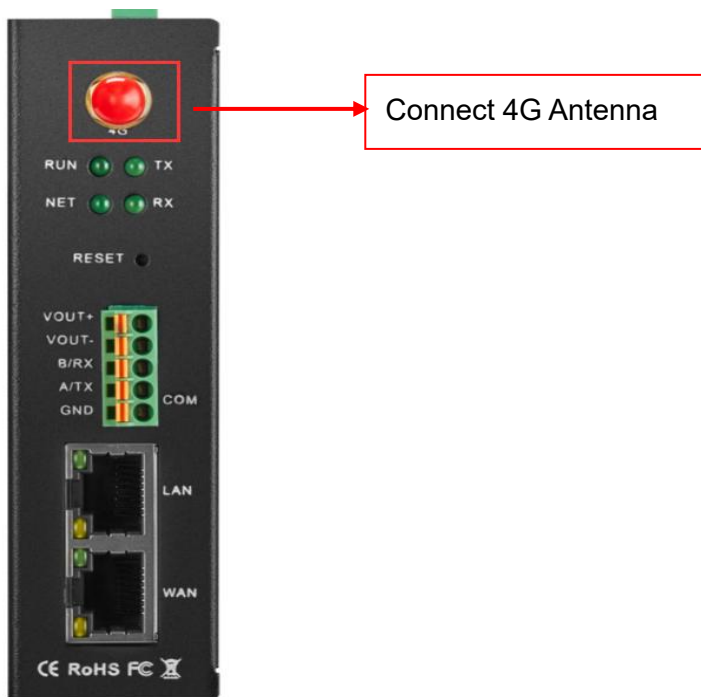

2.7 LED Indicator



LED Indicator Introduction			
	Item Name	Status	Description
RUN	Device Running Indicator	Flickering	Device running normally
		Off	Device faulty
NET	Ethernet or 4G Communication Indicator	Flickering	Ethernet Communication
		On	4G communication
TX	Data Transmitting Indicator	Off	No network
		Flickering	Serial port is transmitting data
RX	Data Receiving Indicator	Off	No data transmitting in serial port
		Flickering	Serial port is receiving data
		Off	No data receiving in serial port

Note: RUN indicator will be on if device is powered. If it's not on, please check whether there's reverse wiring or power source problem.

2.8 Reset Button

Once gateway is running normally, use a PIN to press RESET button for 10seconds until RUN

indicator is off. Gateway BL102 will return to default factory setting.



2.9 COM Port & Power Output Interface

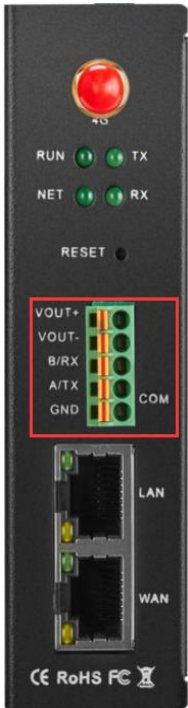

RS485 or RS232 and Power Output	
Item	Description
VOUT+	Positive Pole of Power Output
VOUT-	Negative Pole of Power Output
B/RX	RS485 data-(B)/ receiving data
A/TX	RS485 data +(A)/ transmitting data
GND	Grounding
Note: Power output voltage is equal to input voltage: DC 9~36V	

2.10 WAN & LAN Ports

Ethernet Network Port			
Indicator	Color	Status	Description
Rate	Green	ON	100Mbps mode



Indicator		OFF	10Mbps mode
Network Link Indicator	Yellow	ON	Connected
		Flickering	It's transferring data
		OFF	Disconnected

3 Gateway Mounting

Gateway BL102 can be placed on desk, mounted on the wall and DIN-Rail.

3.1 Wall-Mounting (Optional)

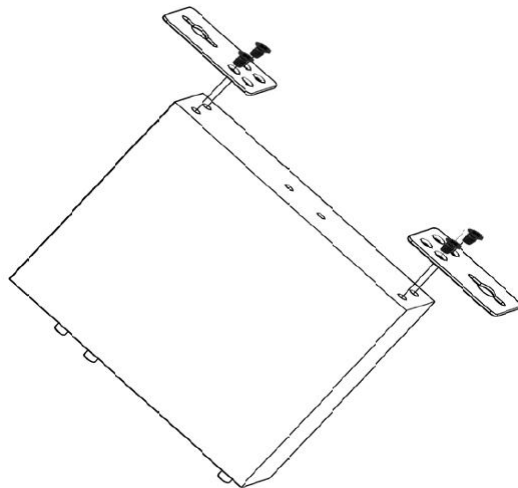

Wall Mounting

3.2 DIN Rail Mounting(Optional)

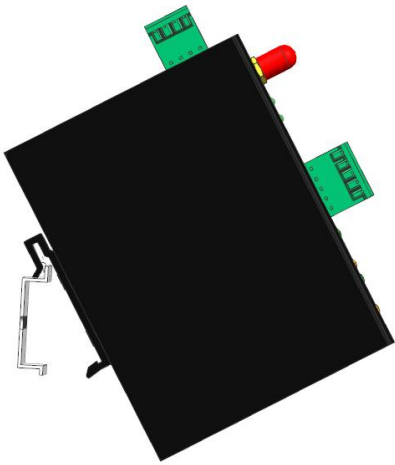

DIN Rail Assembling

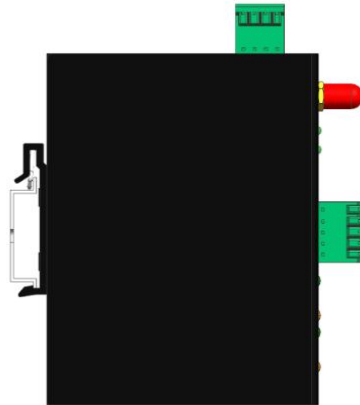

DIN Rail is Assembled

4 Configuration Software Introduction

4.1 Login to Configuration Software

Connect BL102 to router or switch through WAN port with standard direct network cable or cross network cable. Router or switch IP can't be the same as Gateway BL102 IP 192.168.3.1, WAN port and LAN port cannot be in the same local area network. Make sure BL102 and PC are in the same local area network. If it's necessary to connect the gateway to PC directly, use standard cross network cable to connect through BL102 LAN port. (If BL102 is connected to PC directly, PC IP must be specified to 192.168.3.1 as default LAN IP of gateway is 192.168.3.1 from factory setting. IP address, subset mask, MAC and DNS are needed for PC IP setting)

Note: WAN port IP is retrieved automatically, LAN port IP is 192.168.3.1 from factory setting
Connecting BL102 to Router, Switch or PC with following way.

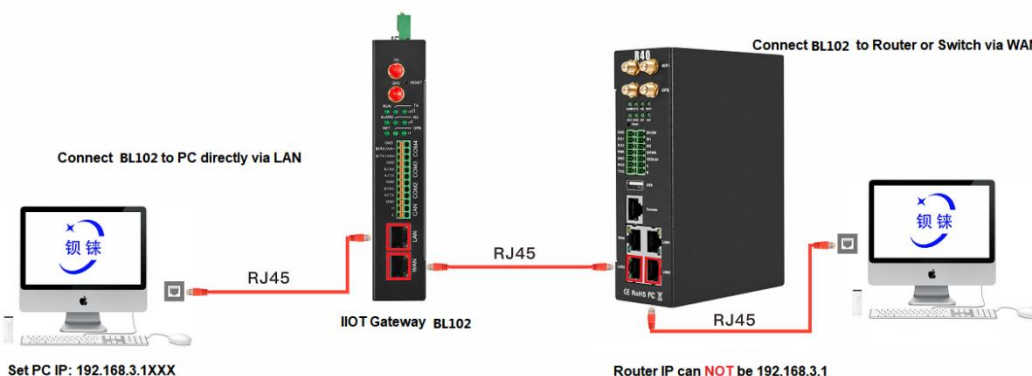

4.1.1 Open Configuration Software

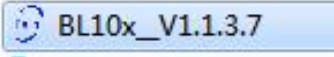
Double click  on PC to run BL102 configuration software and enter below page

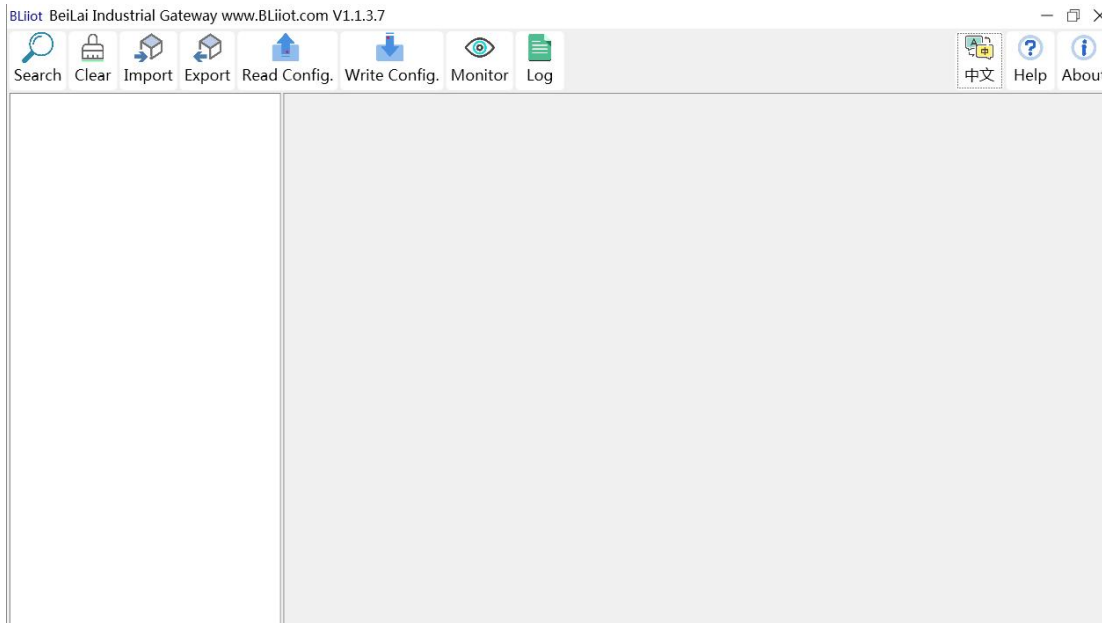

4.1.2 Search for Devices

Click "Search" and all devices in the same local area network with the PC will appear. For example, WAN port is connected to the switch, PC and gateway are in the same local area network, and the gateway whose IP is 192.168.1.131 will be found. If there is no device found, please make sure gateway and computer is in the same local area network, and the computer UDP broadcast is normal. If the device cannot be found because of the computer network environment issues, you can enter the IP in the "IP" bar, click connect, login.

Note: If it's necessary to change PC or Gateway IP, make sure configuration software is closed and open it again.

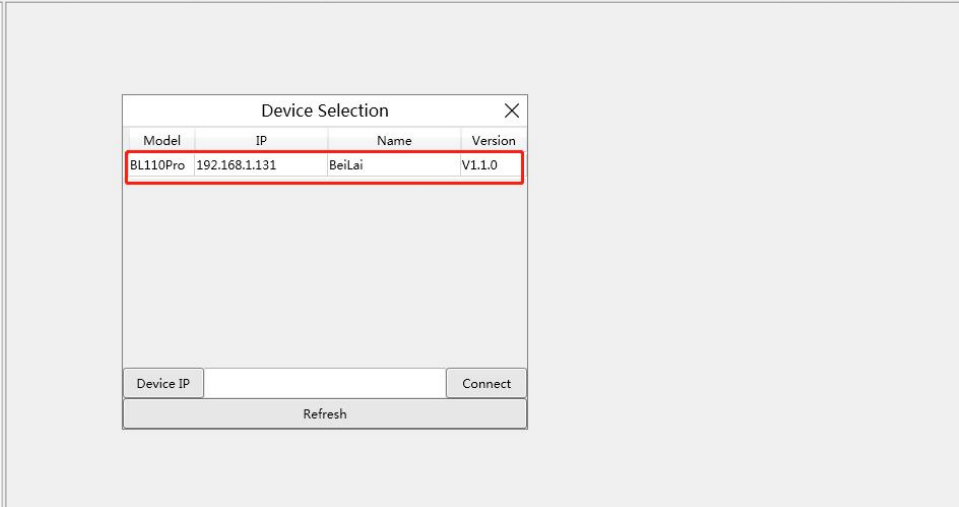
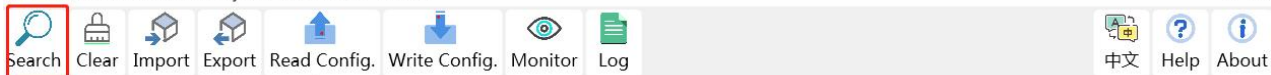

4.1.3 Connecting Gateway

Double click the device to be configured (For example, double click device with IP 192.168.1.131) . to enter the gateway device configuration interface. You can enter the IP and directly connect to log in if there is no display device because of the network environment.

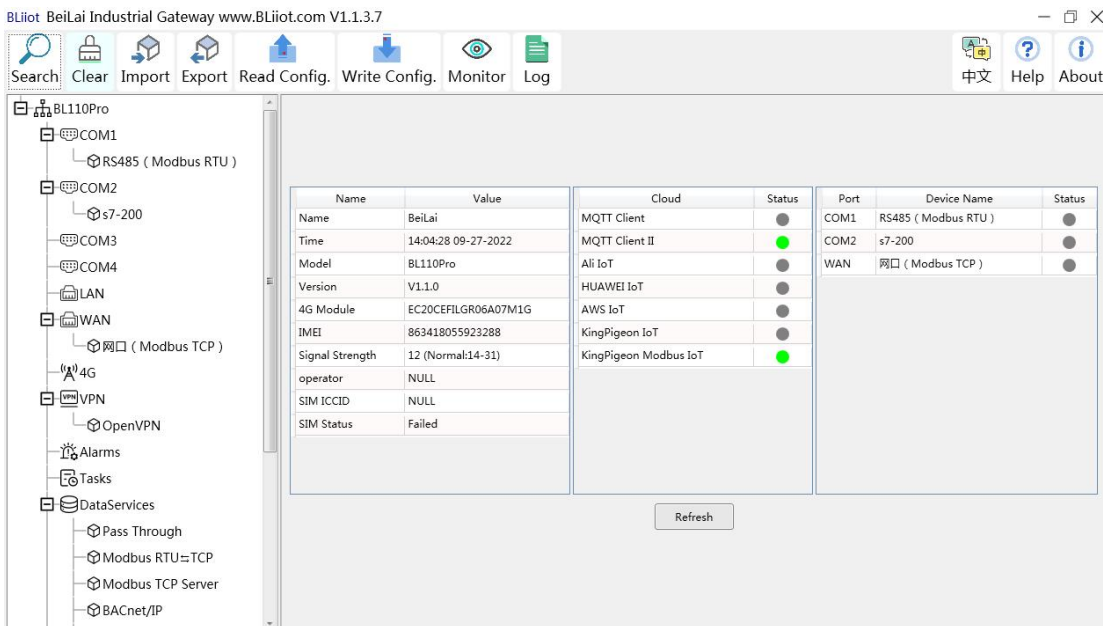

4.2 Configuration Software Introduction

4.2.1 System

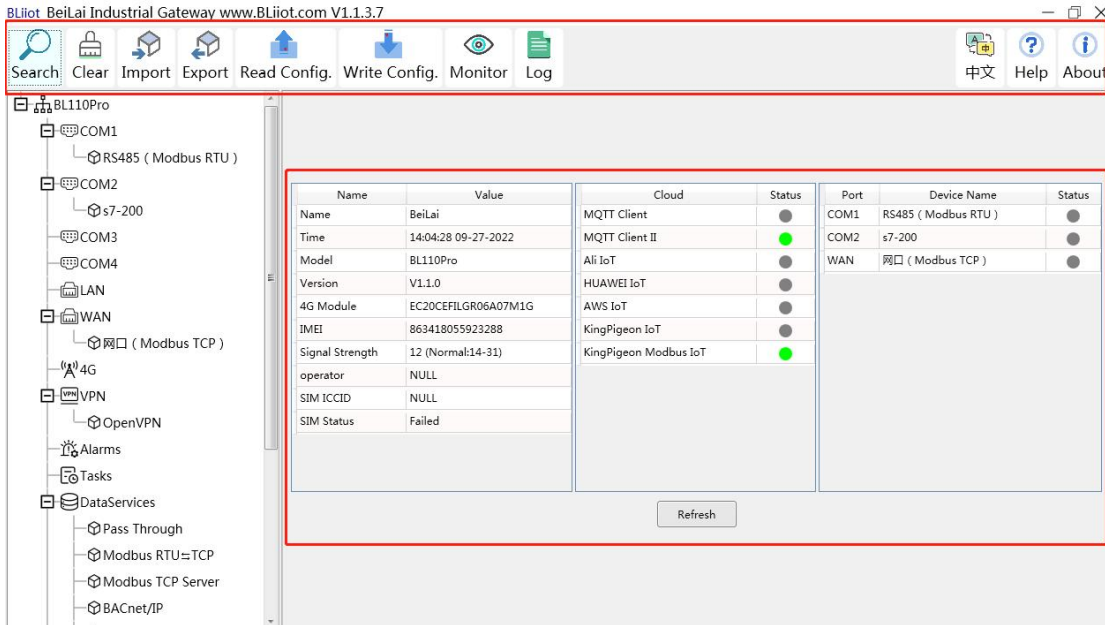

System Function	
Item	Description
Search	Search for all BL102 gateways in the same local area network
Clear	Open a new default configuration file
Import	Import gateway configuration file
Export	Export gateway configuration file
Read Configuration	Read logged-in BL102 gateway configuration parameters
Write configuration	Save all configuration parameters by click "write configuration". Make sure to click "write configuration" every time after modifying the configuration. The setting will be valid after device restarts automatically
Monitor	Monitor the value of the data point of the currently connected device, and the data in the "Value" item of the display data point page.
Log	System running log. If device issue, click save log to send it to specified email box
English	Click it to change language to English
About	Software Version, Issue Date, Firmware upgrade information
Basic Information of Gateway BL102	
Item	Description
Name	BeiLai Gateway. Can be customized

Time	Local time when reading the gateway
Model	Gateway device model
Version	Gateway device version
Signal Strength	4G module signal value. If it's less than 14, it means weak signal. Full signal value is 31
4G Module	Read 4G module model. If it's null, it means no 4G module
IMEI	Device IMEI code
Operators	SIM card service provider
SIM ICCID	Read SIM card ICCID
SIM Status	"OK" means the SIM card is successfully registered, "Failed" means it is not registered
King Pigeon IoT	Green light means King Pigeon MQTT Client is connected, gray means King Pigeon MQTT Client is not connected.
King Pigeon Modbus IoT	Green light means King Pigeon Modbus cloud is connected, gray means King Pigeon Modbus cloud is not connected.
MQTT Client	Green light means MQTT Client is connected, gray means MQTT Client is not connected
MQTT Client II	Green light means MQTT Client II is connected, gray means MQTT Client II is not connected.
Ali IOT	Green light means Alibaba cloud is connected, gray means Alibaba is not connected.
HUAWEI IOT	Green light means HUAWEI cloud is connected, gray means HUAWEI not connected.
AWS IOT	Green light means AWS is connected, gray means AWS is not connected.
Device Online Status Prompting Box	Green indicates gateway is communicating with slave devices Gray indicates gateway fails to communicate with salve device
Refresh	Refresh basic information of gateway

4.2.2 Advanced Settings

The private network setting is to allow the dedicated Ethernet or dedicated 4G network to set the IP that can be used or the server that can be connected. If it is an ordinary Ethernet or 4G network, no settings are required.

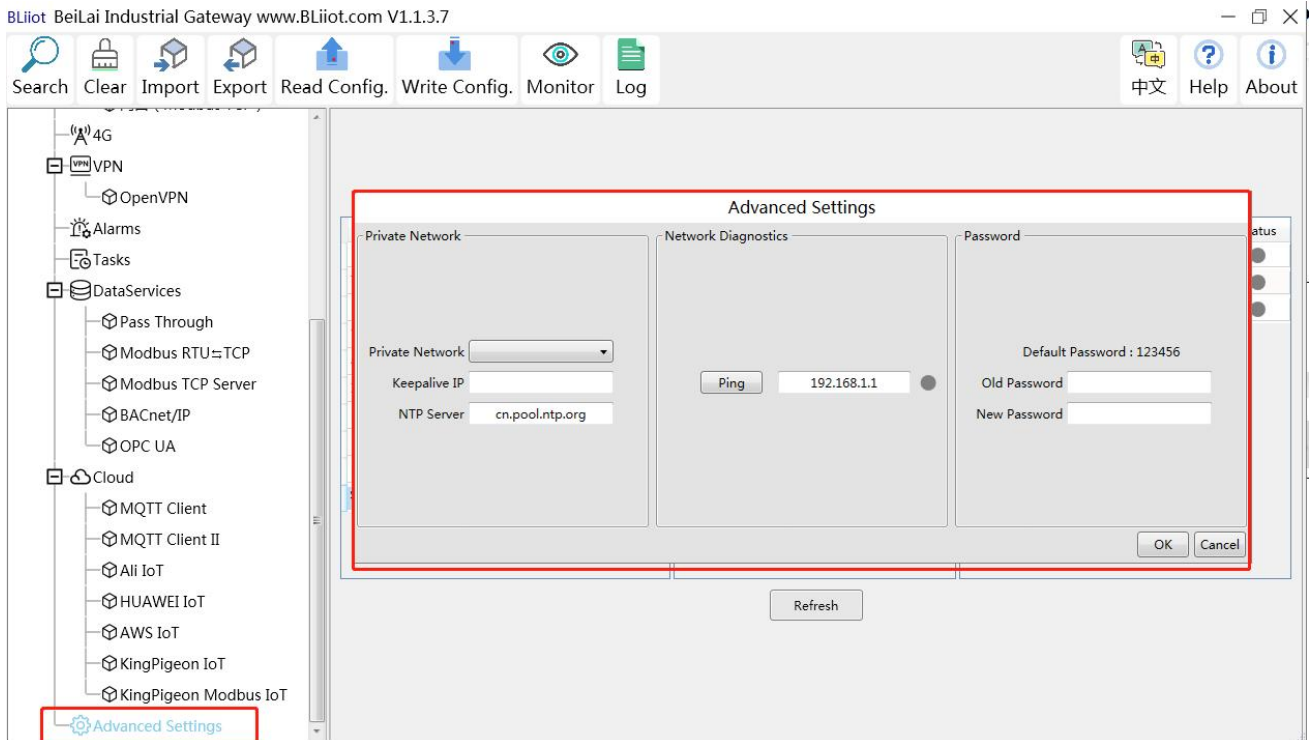

Advanced Setting		
Item		Description
Private network	Private network	Choose from "WAN" and "4G" according to your needs, and only configure it with a dedicated network.
	Keepalive IP	Dedicated IP that can be used
	NTP Server	Dedicated connected NTP server
Network Diagnosis	Ping	Ping the gateway IP connected to the network port, you can judge whether the LAN connected to the BL102 network port is normal, fill the gateway IP, click Ping, green means normal.

4.2.3 COM Port Configuration

4.2.3.1 COM Port Attribute Configuration

Double click COM1. Serial Port Attributes box will pop up for configuration

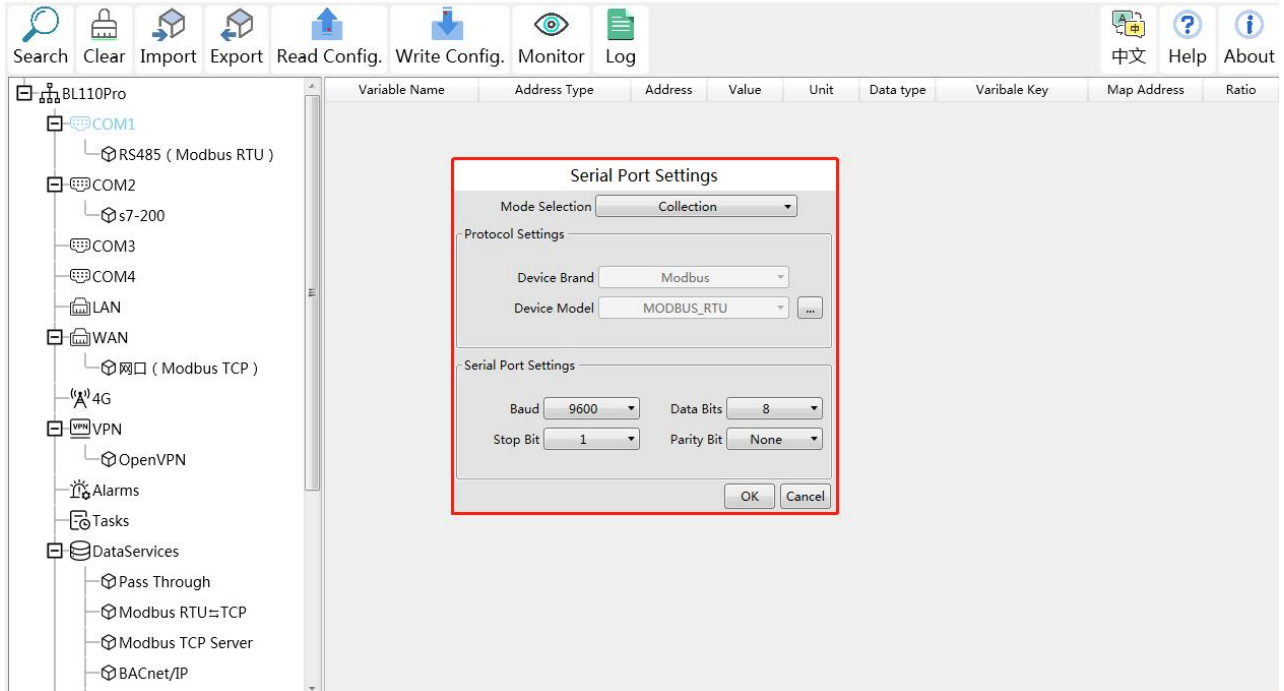

Item	Description	Default
Mode Selection	Select from "Collection", "Pass through", "Modbus RTU to TCP"	Collection
Protocol Settings	Device Brand	Select from "Modbus", "Mitsubishi", "Siemens", "OMRON", "DELTA"
	Device Model	Select slave device according to selected brand
	Polling Interval And Time out	Device command interval time and device return timeout time, click the button next to the device model to set it.
Serial Port Settings	Baud Rate	Select from "1200", "2400", "4800", "9600", "19200", "38400", "57600", "115200"
	Stop Bit	Select "1Bit" or "2Bit"
	Data Bit	Select "7Bit" or "8Bit"
	Parity Bit	Select "None", "Even", "Odd"
OK	Confirm COM configuration	
Cancel	Cancel COM port configuration	

4.2.3.2 Add COM Port Connected Device

Right click COM1 and click Add to add PLC. Device configuration box will pop up. For the added device, double click it to show device configuration information. Right click to delete device.

The byte order of the configuration data points is also set here

Note: Maximum 50 same model PLC data can be collected through COM

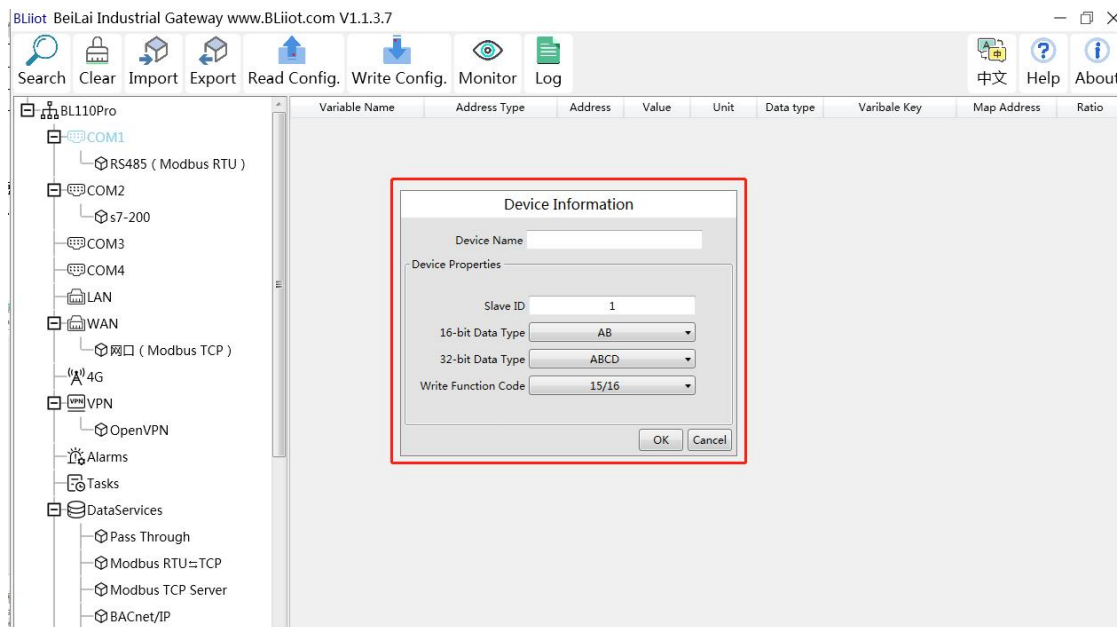
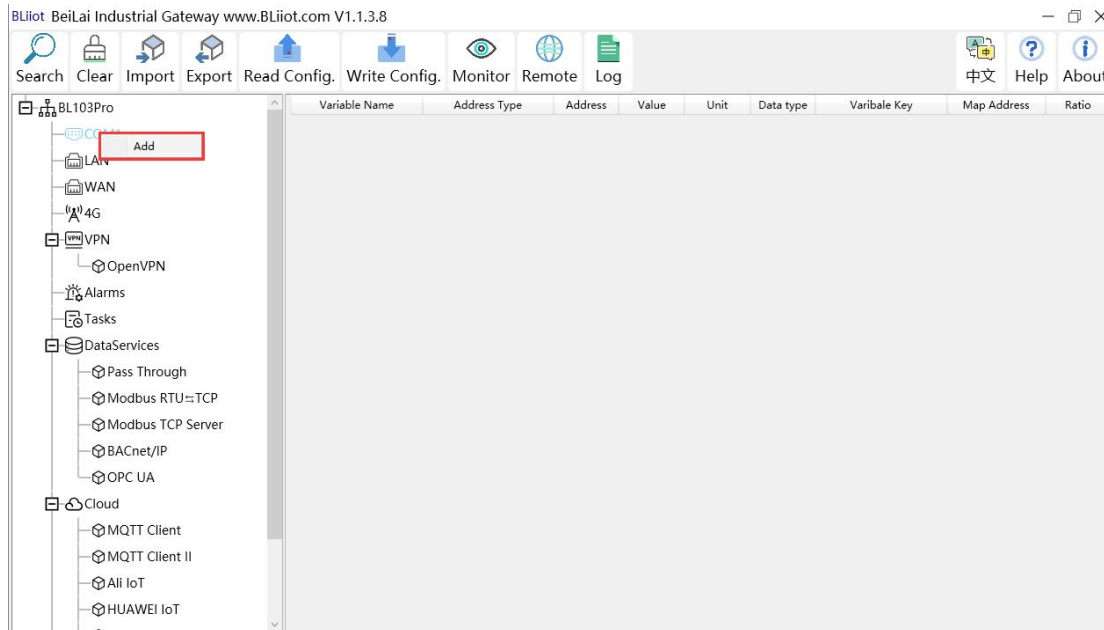

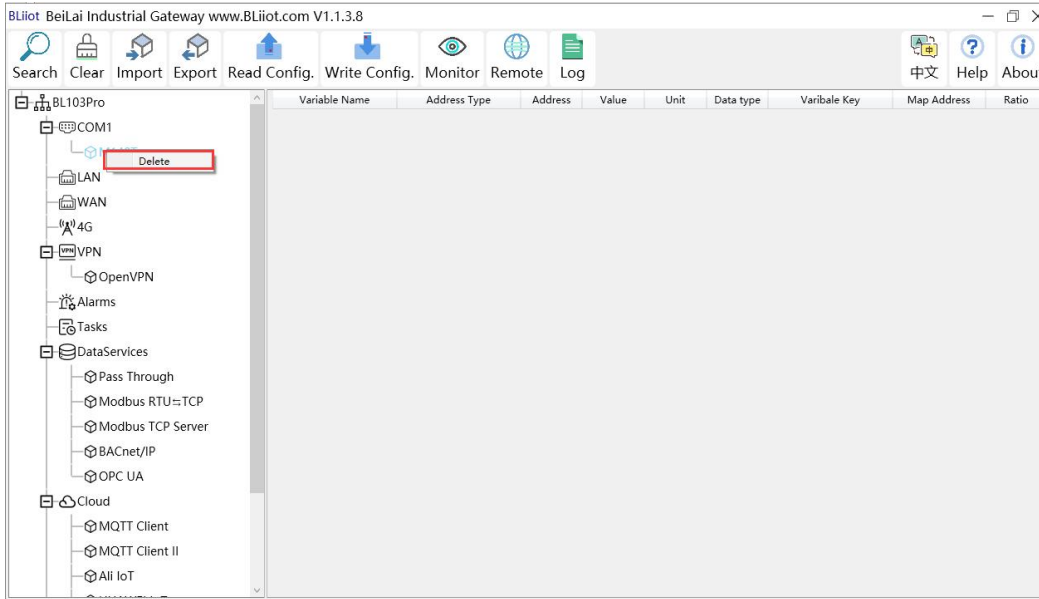

Note: For different PLCs, the protocols are different and the configuration items are different. For example, if selecting Modbus as device brand, then the configuration is as below table:

Device Information			
Item	Description		Default
Device Name		Name of Device to be connected to COM	
Device Property	Slave ID	COM port device Modbus communication address	
	16-bit Data Type	Select from "AB" and "BA"	AB
	32-bit Data Type	Select from "ABCD", "DCBA", "BADC" and "CDAB"	ABCD
	Write function code	Select from 05/06, 15/16	15/16
OK		Confirm device configuration	
Cancel		Cancel device configuration	

4.2.3.3 Add COM Port Device Datapoint

Click device name and then right click the box on the right, click Add to enter data point configuration box. The outside of the mapping address on the configuration software represents the Modbus address, and M.XXX in the brackets represents the PLC Modbus address.

Right click "Add" to add the next data point. You can also right click to delete the data, or double click the data point to edit the data.

Add data points by importing and exporting Excel file. First, create some data points to export, the configuration content of the Excel file is the same as the information configuration principle of the data point configuration box. The variable name, variable label, mapping address, and collection

address can not conflict.

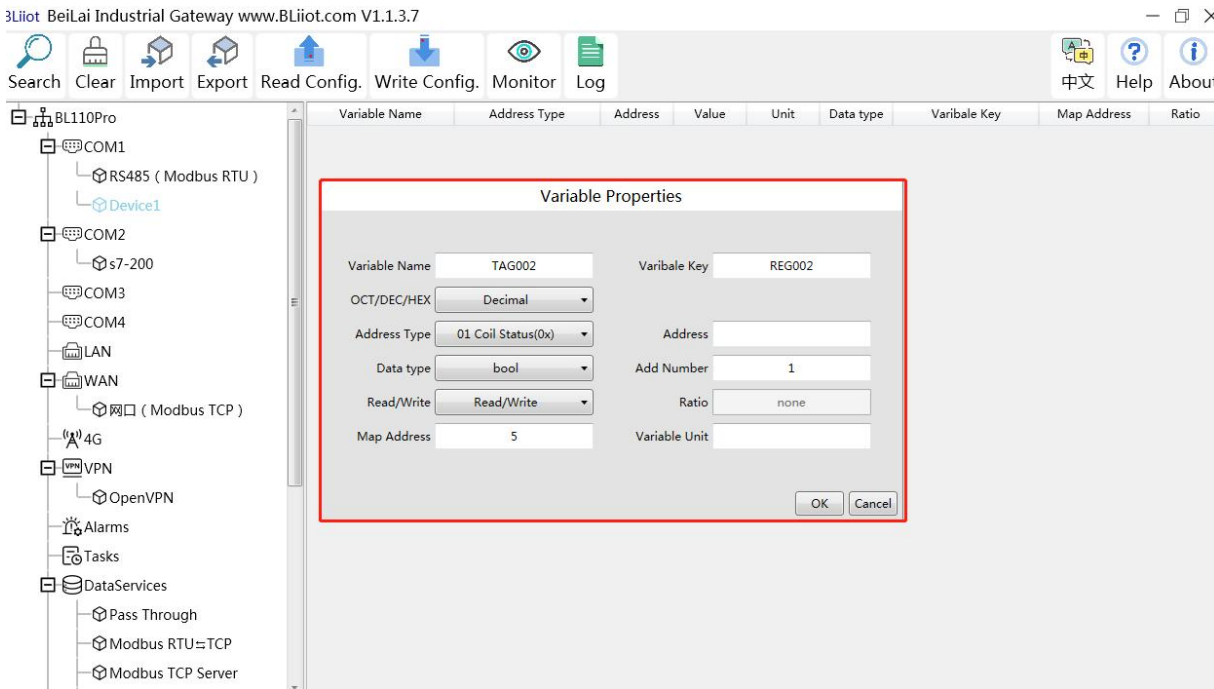
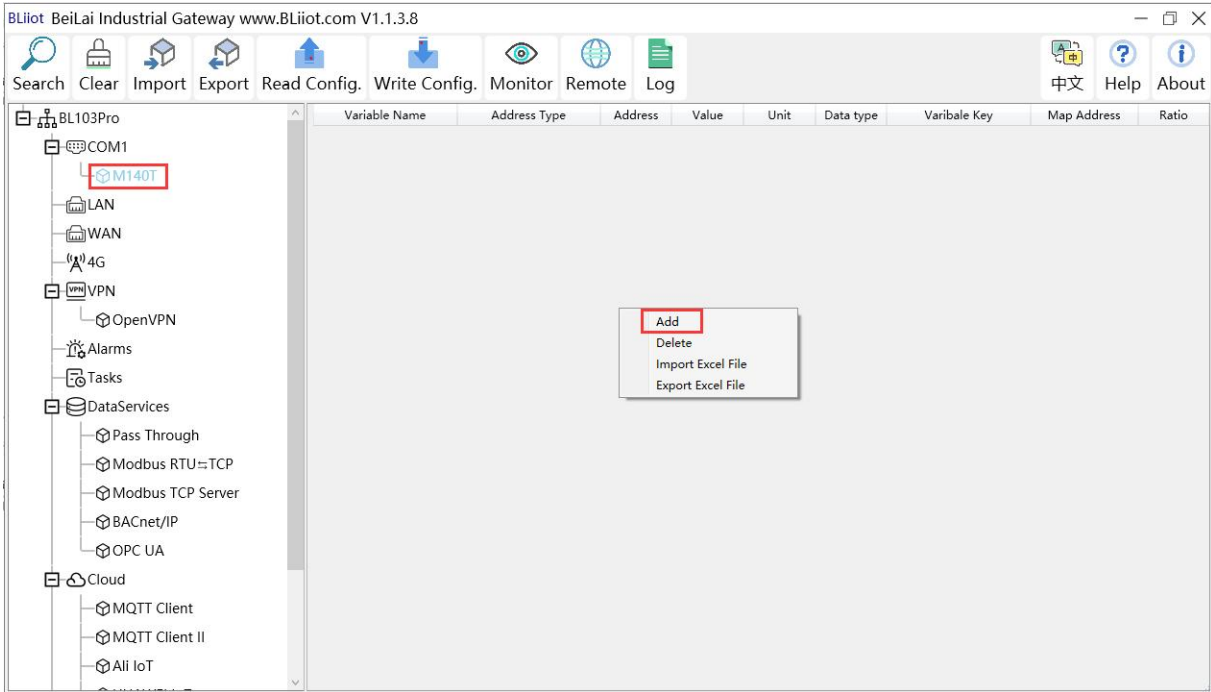

Variable Properties	
Item	Description
Variable Name	Name of Added Datapoint
Variable Key	The MQTT identifier of the data point, can be filled in arbitrarily.
OCT/DEC/HEX	Select from "decimal", "octal", "hexadecimal" according to the collection address
Address Type	Select the register type of the device, different protocols display differently

Address	Address of the collected data point
Data Type	Select from Boolean, 16-bit unsigned integer, 16-bit signed integer, 32-bit unsigned integer, 32-bit signed integer, 32-bit single precision floating point
Add Number	Datapoint Quantity
Read/Write	Select “read only”, “read and write”
Ratio	Only set for numeric data. Data can be magnified or minified with certain ratio before sending to cloud
Map address	Address in Gateway where datapoints are stored. Boolean: 0~2000 addresses, Numeric: 0-2000 addresses. Each register address space is one character
Variable unit	The unit of the data point, fill in as needed, not required.
OK	Confirm datapoint setting
Cancel	Cancel datapoint setting

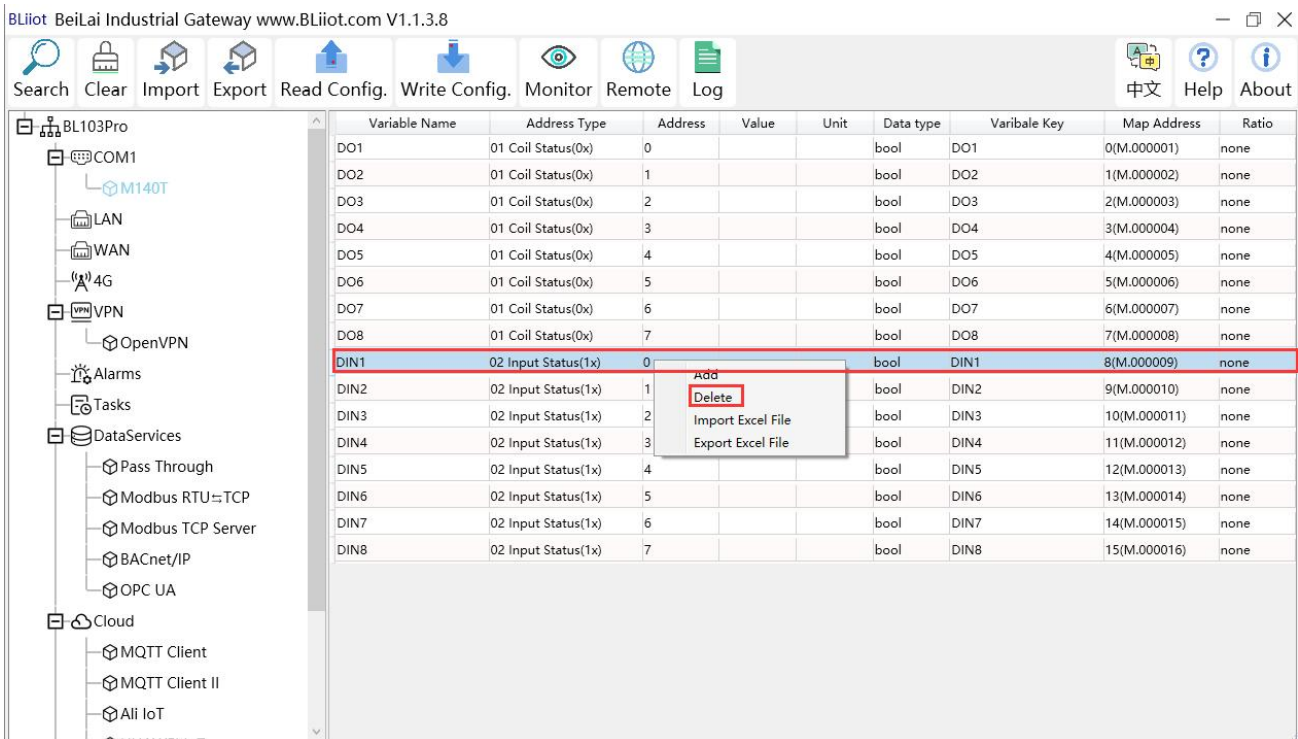

Right click datapoint to delete it and double click it to edit it.

4.2.4 LAN Port Configuration

4.2.4.1 LAN Port Attribute Configuration

Double click LAN port to enter setting page. Factory default IP of LAN is 192.168.3.1. Auto IP address

distribution and routing functions are turned off in factory setting.

Note: If LAN port is connected to switch, the IP of all devices connected to switch must be the same as LAN port IP.

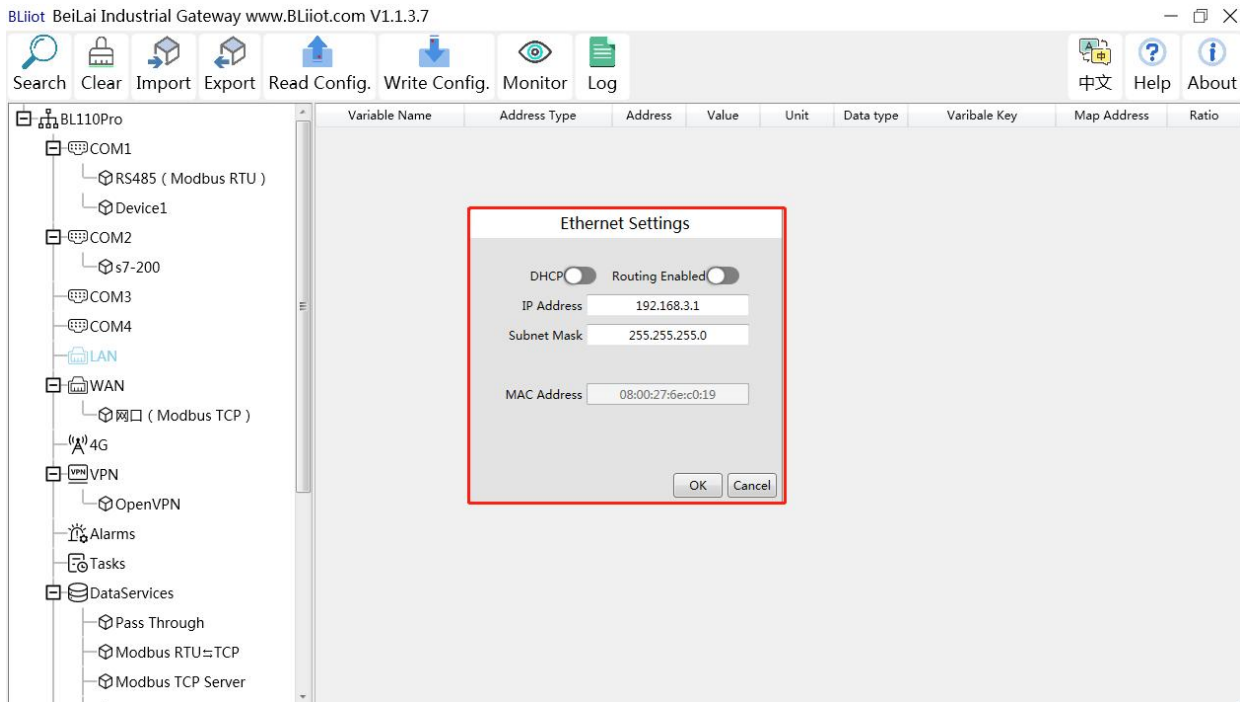

LAN Port Configuration	
Item	Description
DHCP	Green indicates auto IP distribution for LAN is enabled Gray indicates auto IP distribution for LAN is turned off
Routing	Green indicates routing function is enabled. Gray indicates routing function is turned off
IP Address	LAN port IP Address
Subnet mask	LAN Port subnet mask
MAC Address	LAN port MAC
OK	Confirm LAN port Setting
Cancel	Cancel LAN port setting

4.2.4.2 Add Device to LAN Port

Right click LAN and click Add to enter device configuration page. PLC data can be collected through Gateway BL102 LAN Port or through switch which is connected with LAN.

Note: Total 50 PLCs can be connected through LAN and WAN, different models from different PLC makers can be connected simultaneously.

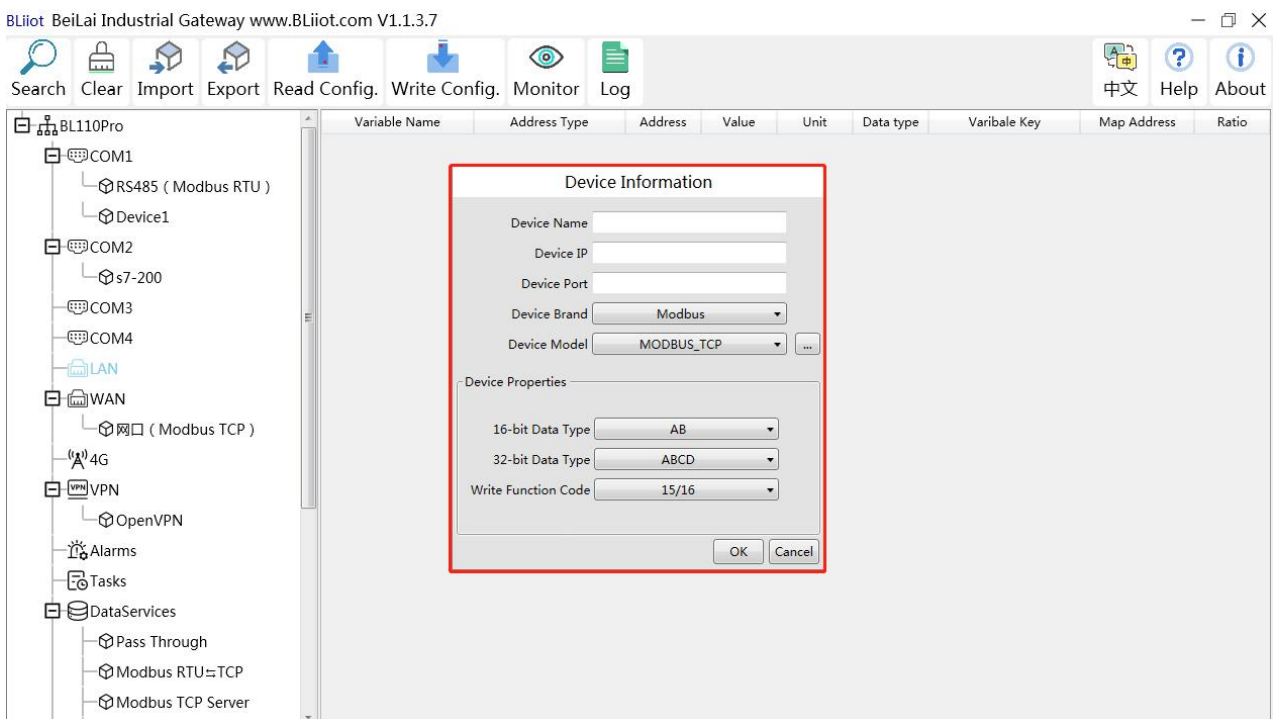
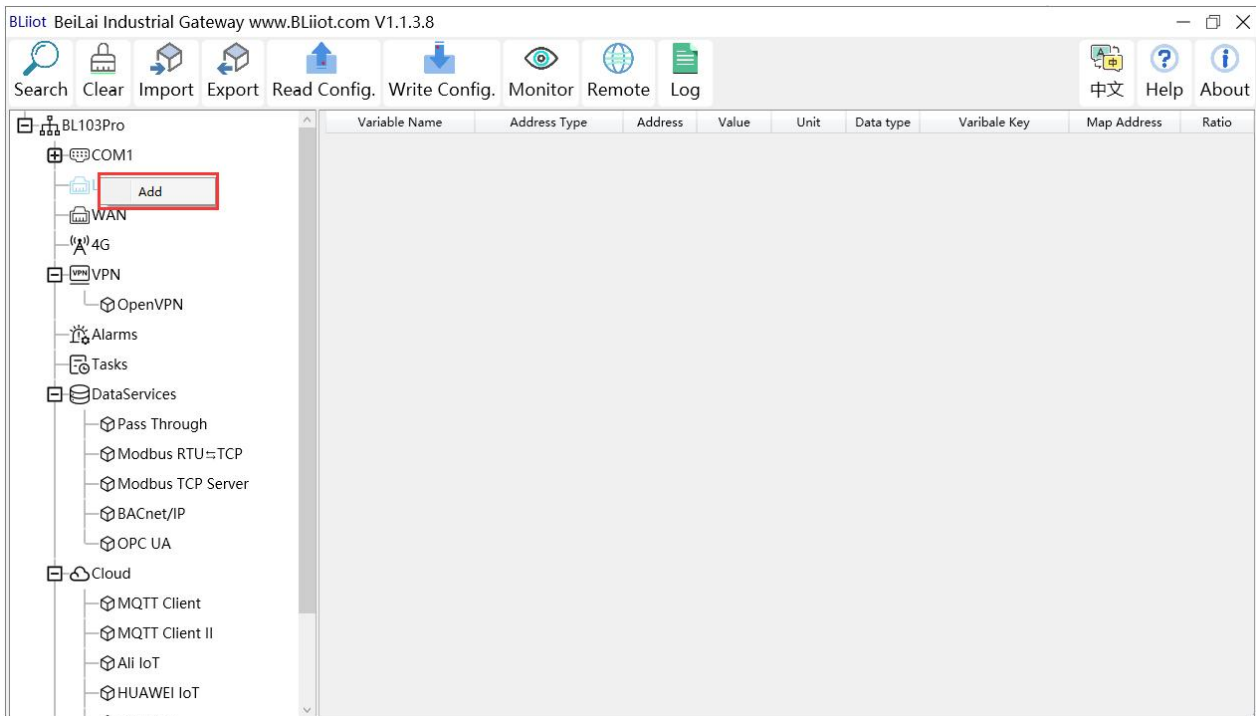

LAN Port Device Configuration	
Item	Description
Device Name	LAN Port PLC Name
Device IP	Set IP Address of LAN port PLC. PLC IP Address must be the same as Gateway BL102 LAN IP Address. If it's not the

	same, need to change PLC IP address or LAN port IP address. To change LAN port configuration, it will not take effective until restart after power off
Device Port	Set LAN PLC port
Device Brand	Select from Modbus, Mitsubish, Siemens, OMRON
Device Model	Select PLC Model
Polling interval and Time out	Command interval time and device return timeout time, click the button next to the device model to set it.
16-bit Data Type	Select "AB" or "BA", only configure it if Modbus is selected as device brand.
32-bit Data Type	Select "ABCD", "DCBA", "BADC" or "CDAB", only configure it if Modbus is selected as device brand.
Write function code	Select from "05/06", "15/16"
OK	Confirm LAN port device setting
Cancel	Cancel LAN port device setting

4.2.4.3 Add LAN Port Device Datapoint

Follow the same procedure of adding datapoints for COM port device to add datapoints of LAN port device. ID of the Modbus TCP device is configured in the data point configuration box.

[Add COM Port Device Datapoint](#)

4.2.5 WAN Port Configuration

4.2.5.1 WAN Port Attribute Configuration

Double click WAN to enter WAN port configuration box

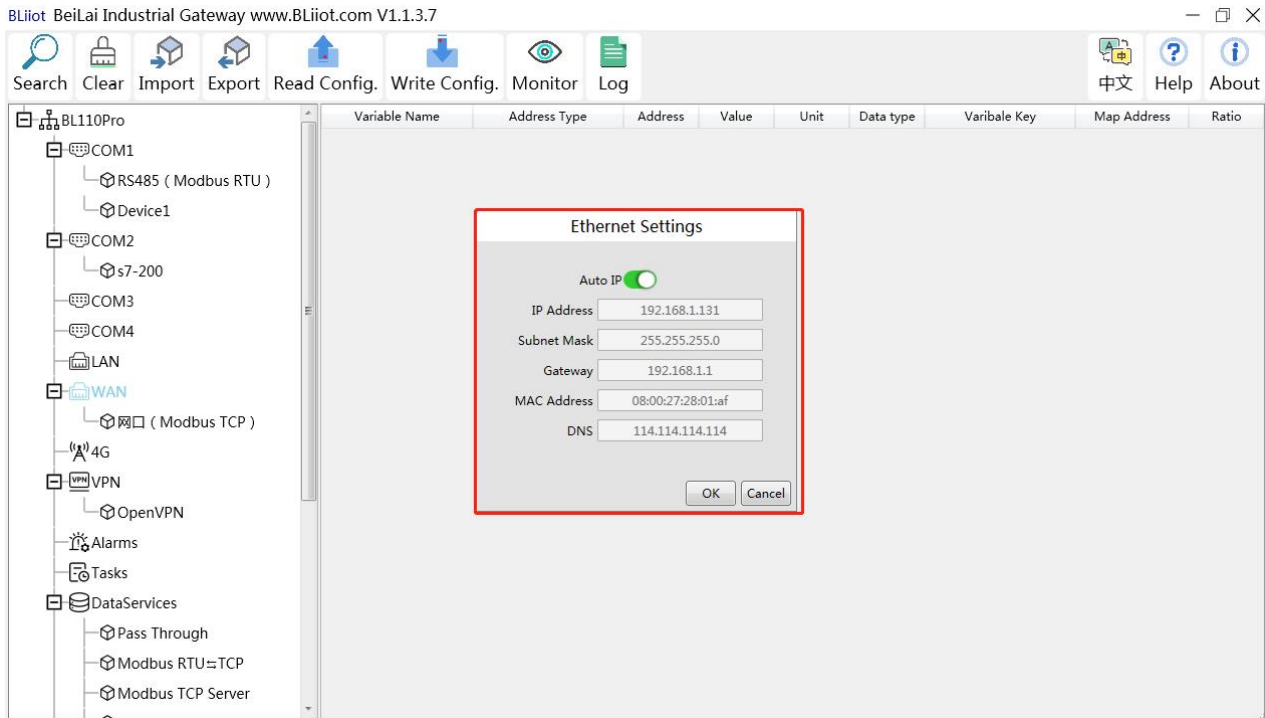

WAN Port Configuration	
Item	Description
Auto IP	Green indicates auto retrieving IP Gray indicates IP is specified
IP Address	Current IP Address of WAN Port
Subnet Mask	Current WAN Subnet Mask
Gateway	Current WAN Gateway Address
MAC Address	WAN port MAC address
DNS	Current WAN port DNS server
OK	Confirm WAN port setting
Cancel	Cancel WAN port setting

4.2.5.2 Add Device to WAN Port

Right click WAN and click Add to enter device configuration page. PLC data can be collected through Gateway BL102 WAN Port or through switch which is connected with WAN.

Note: Total 50 PLCs can be connected through LAN and WAN, different models from different PLC makers can be connected simultaneously.

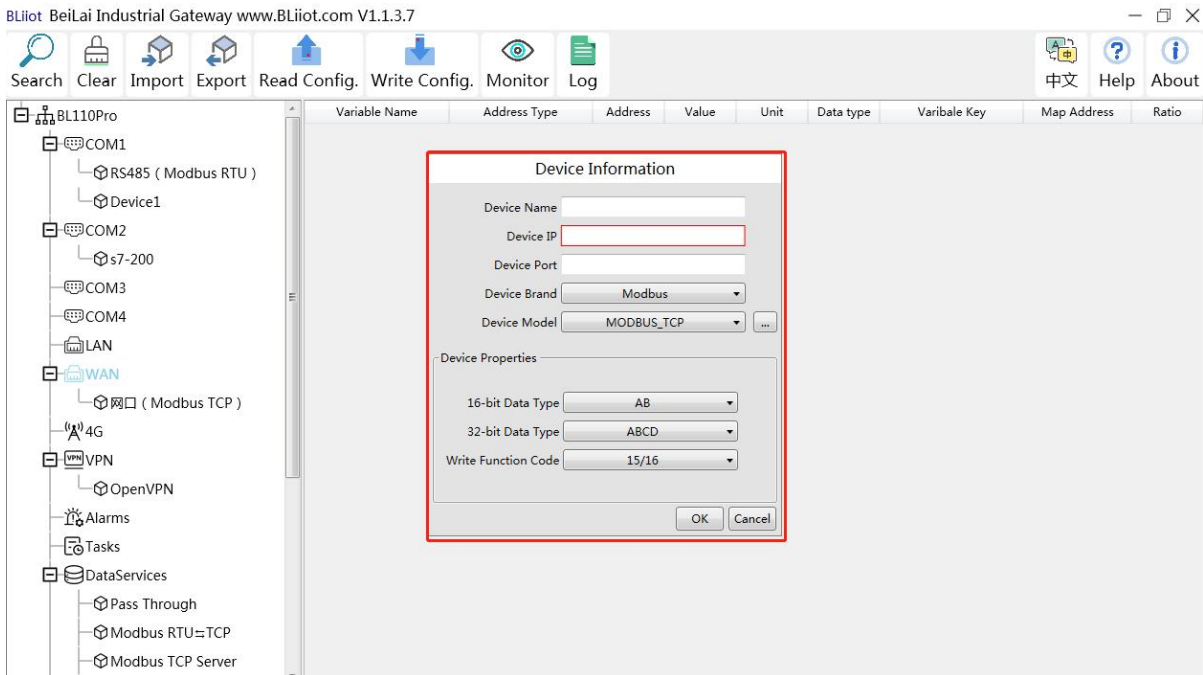
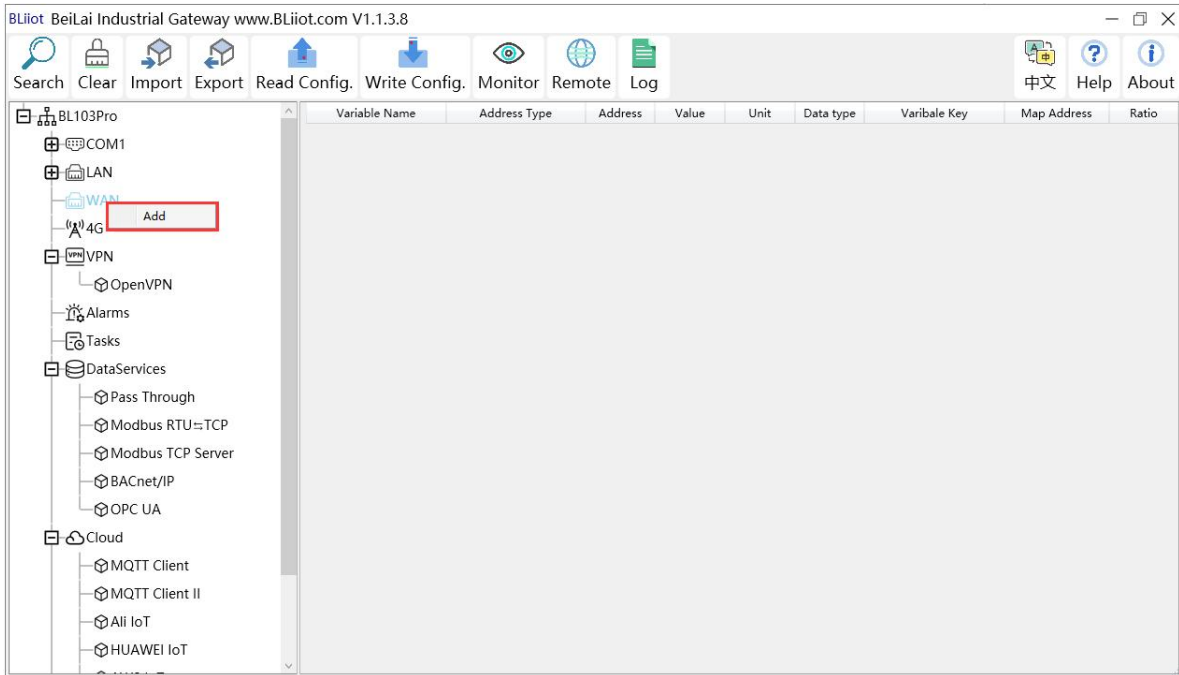

WAN Port Device Configuration	
Item	Description
Device Name	Name of WAN Port PLC
Device IP	IP Address of WAN Port PLC
Device Port	WAN port PLC Port
Device Brand	Select from Modbus, Mitsubishi, Siemens, OMRON
Device Model	Select PLC Model
Polling interval Time out	Command interval time and device return timeout time, click the button next to the device model to set it.

16-bit Data Type	Select "AB" or "BA", only configure it if Modbus is selected as device brand.
32-bit Data Type	Select "ABCD", "DCBA", "BADC" or "CDAB", only configure it if Modbus is selected as device brand.
Write function code	Select from "05/06", "15/16"
OK	Confirm WAN port device setting
Cancel	Cancel WAN port device setting

4.2.5.3 Add WAN Port Device Datapoint

Follow the same procedure of adding datapoints for COM port device to add datapoints of WAN port device. ID of the Modbus TCP device is configured in the data point configuration box.

[Add COM Port Device Datapoint](#)

4.2.6 4G Network Introduction

Double click 4G to enter APN setting box.

Note: It's not necessary to set APN for China mainland 4G network. If no 4G module in the device, it's not needed to set it either

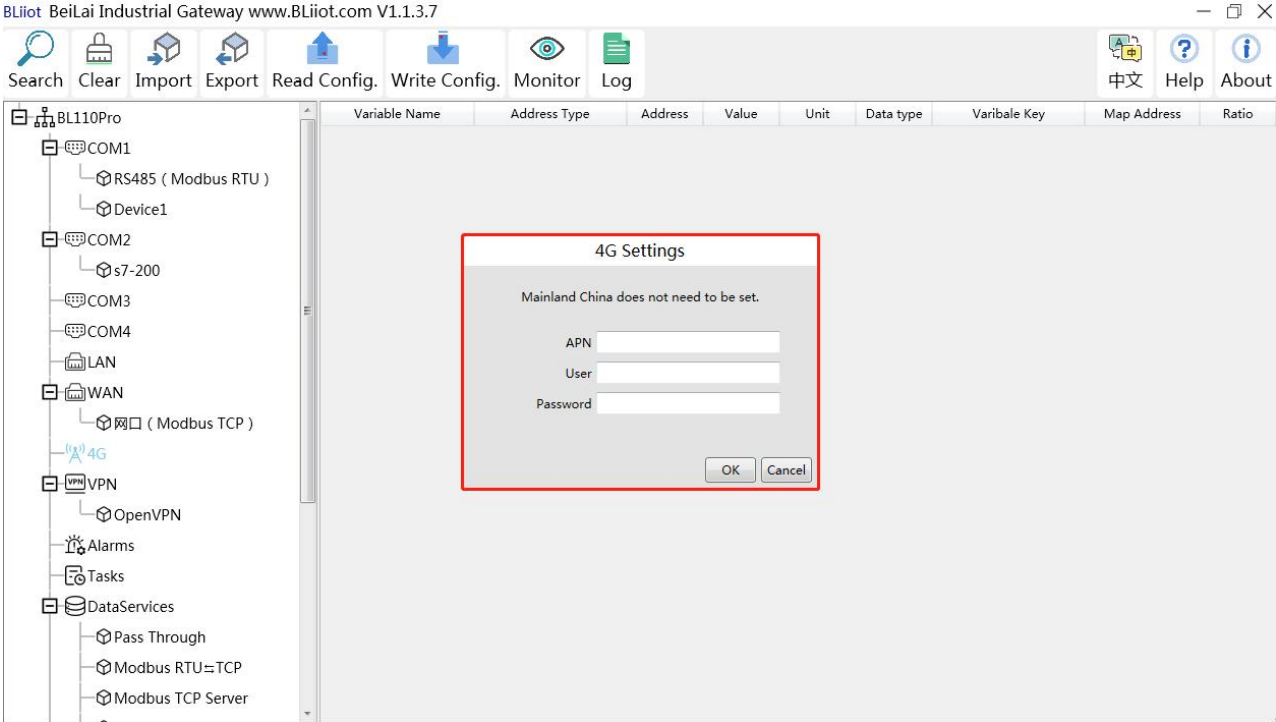

4G Configuration

Item	Description
APN	Access Point Name of SIM card cellular network
User Name	User Name of SIM card cellular network
Password	Password of SIM card cellular network

4.2.7 OpenVPN Introduction

Only BL12Pro have the OpenVPN function, and the gateway device is the client. According to the IP assigned by the OpenVPN server to the gateway device client, you can directly enter the gateway client IP in the "Device IP" item of the configuration software login interface, and click Connect to log in to the gateway device.

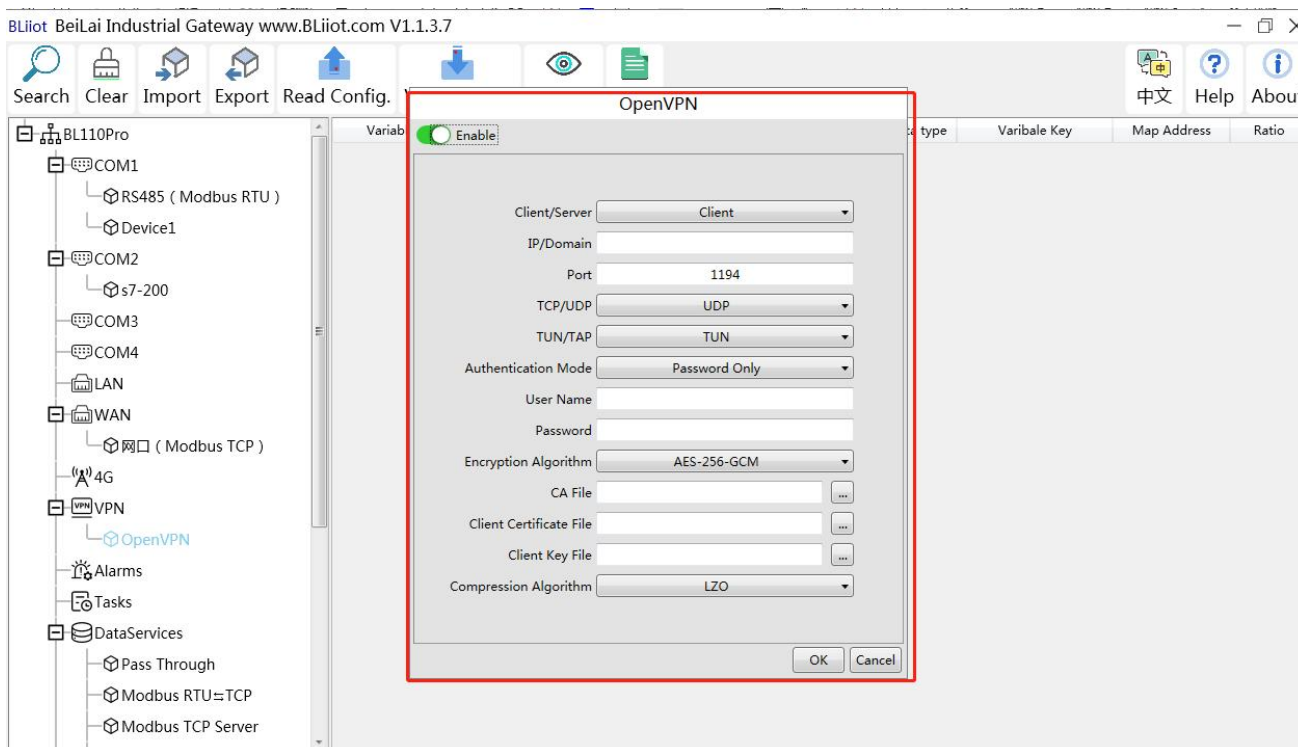

OpenVPN	
Item	Description
Client/Server	Gateway device as client "Client"
IP/domain name	The address of the server with which the client establishes an OpenVPN connection
Port	The TCP/UDP port provided by the server for establishing a connection, the default is 1194.
TCP/UDP	The protocol used in the communication between the client and the server, and the connection method is selected according to the server.
TUN/TAP	In TUN mode, 3 Layer tunnel is established to realize point-to-point transmission. In TAP mode, 2 Layer tunnel is

	established to implement transparent transmission of IP packets. Select the connection method according to the server.
Authentication Mode	Select from "Password Only", "Certificate Only", "Password and Certificate" as required
User name	Username of the client, not required for "certificate only" mode.
Password	Client user name password, not required for "certificate only" mode.
Encryption Algorithm	Select the data encryption algorithm, and select the connection encryption algorithm according to the server.
CA File	Select File Upload, the root certificate provided by the OpenVPN server.
Client Certificate File	Select File Upload, the client certificate generated by the user based on the root certificate.
Client Key File	Select File Upload, the key corresponding to the client certificate.
Compression Algorithm	Select from "LZO" and "LZ4" according to the OpenVPN server selection.
OK	Confirm OpenVPN configuration
Cancel	Cancel OpenVPN configuration

4.2.8 Alarms and Events Configuration

Click "Alarms", move the mouse to the right box, right click, click "Add", to enter "Alarm and Event" setting box. You can configure the data points, action and the action to be performed for alarm recovery.

4.2.8.1 Alarm Point Configuration

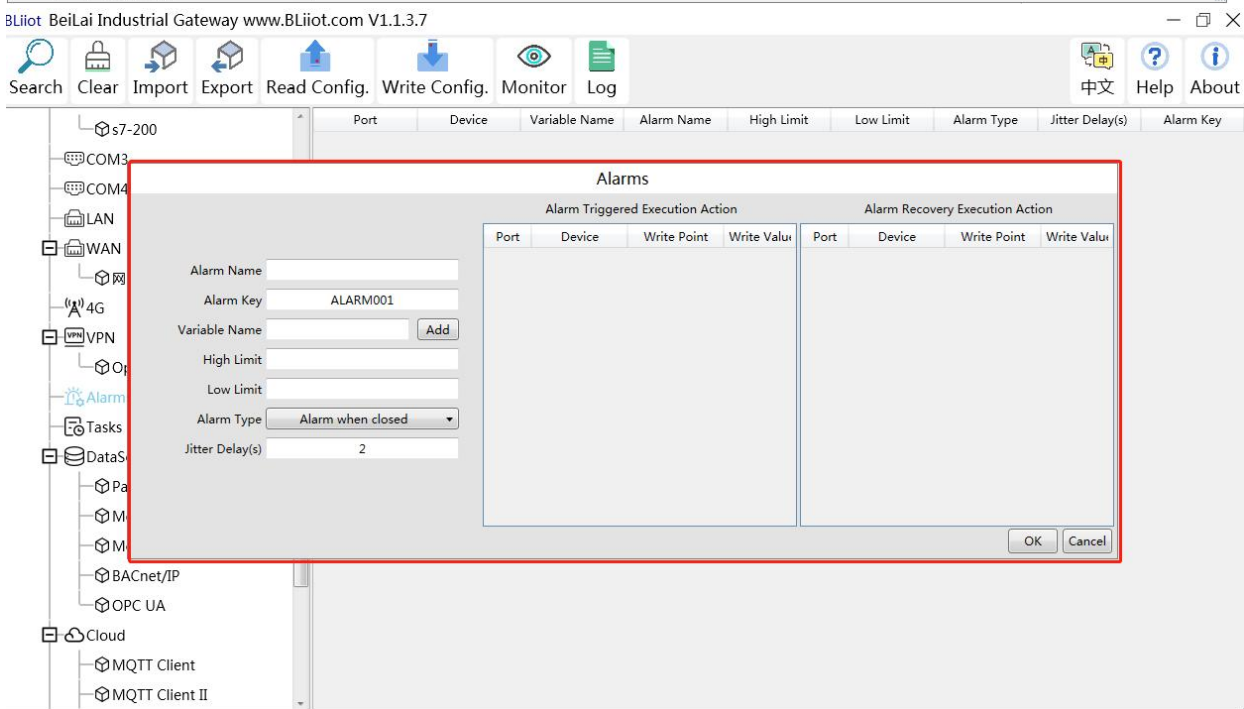
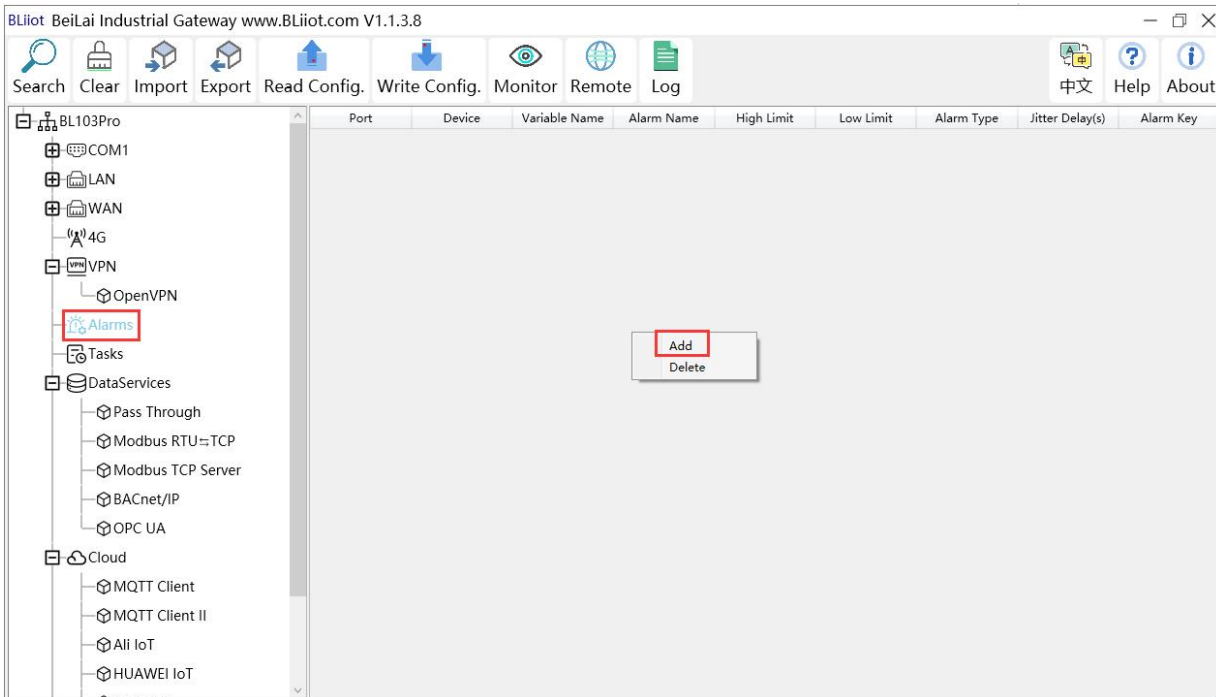

Alarm and Events Configuration	
Item	Description
Name	Name of Alarm Point
Alarm Key	MQTT flag of alarm point, can be randomly set
Variable Name	Select alarm point and click Add. Datapoint box will pop up. Click the point to be set for alarm and click OK to confirm. Double click

	datapoint to enter datapoint attribute page
High Limit	High Limit alarm value of numeric datapoints
Low Limit	Low limit alarm value of numeric datapoints
Alarm Type	Select from digital alarm mode: Normally Open or Normally Close
Jitter Delay	Within alarm acknowledge time, if data will recover to normal value, no alarm will be triggered. Otherwise it will generate alarm
OK	Confirm alarms and events setting
Cancel	Cancel alarms and events setting

4.2.8.2 Alarm Event Configuration

Put mouse in "Alarm triggered execution action", right click the prompt box, click "Add" to enter event configuration box, and set the operation to be performed when the alarm is triggered. In the same way, put mouse on "Alarm recovery execution action", set operations when the alarm release.

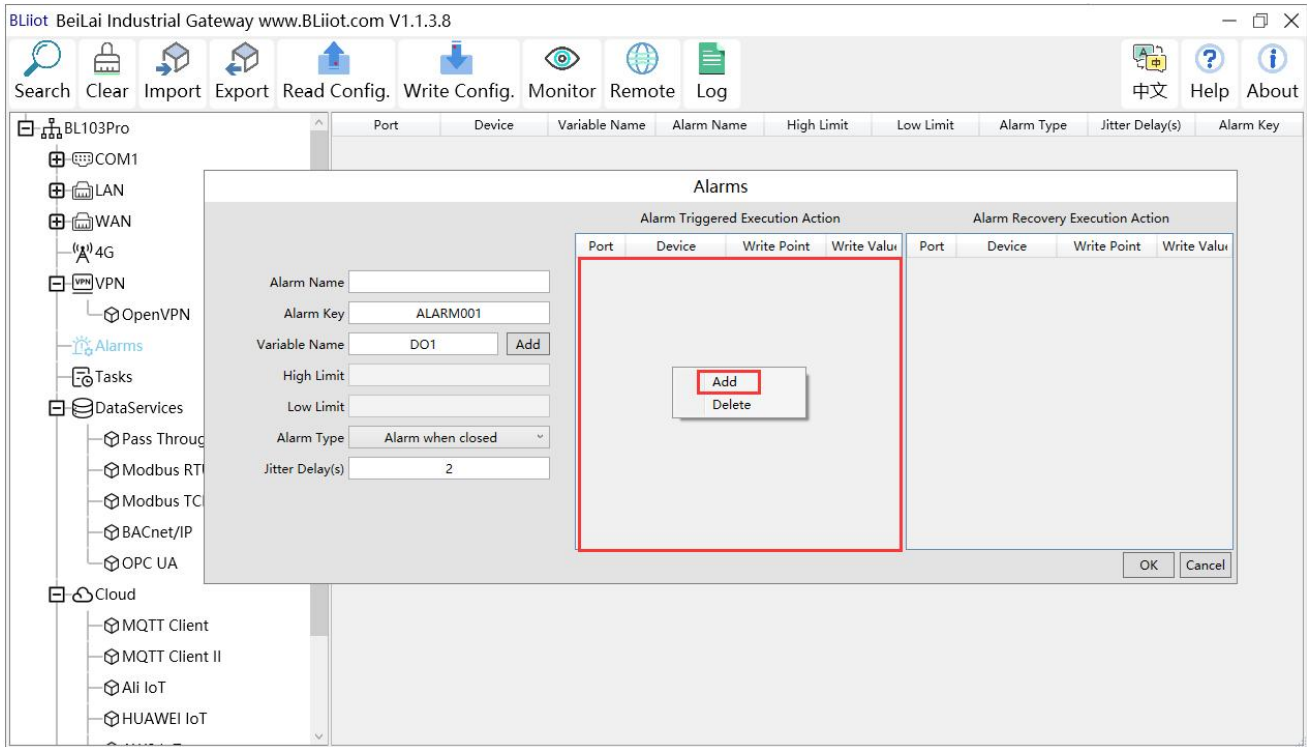

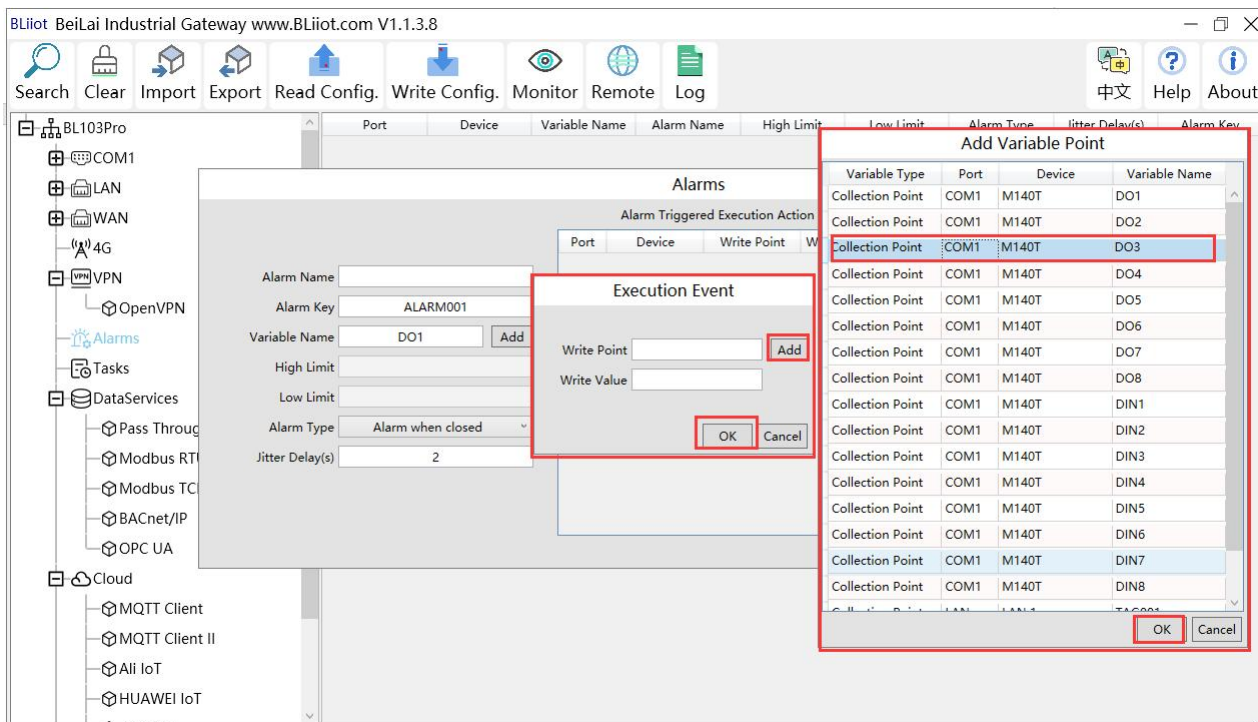

Event Configuration	
Item	Introduction
Write Point Name	Generate the point name according to the selected data point, click "Add" to select the data point to be operated. Click on the data point and click OK
Write Value	Write the value of the data point to be operated, write "1" or "0" for Boolean, "0" means open, "1" means close.

4.2.9 Task Plan Configuration

Left click on "Task", move the mouse to the right box, click the right mouse, "Add" will pop up, click "Add", to enter task schedule setting box, put the mouse in the box, and right click to enter the operation box, click "Add", to enter Execution Event box.

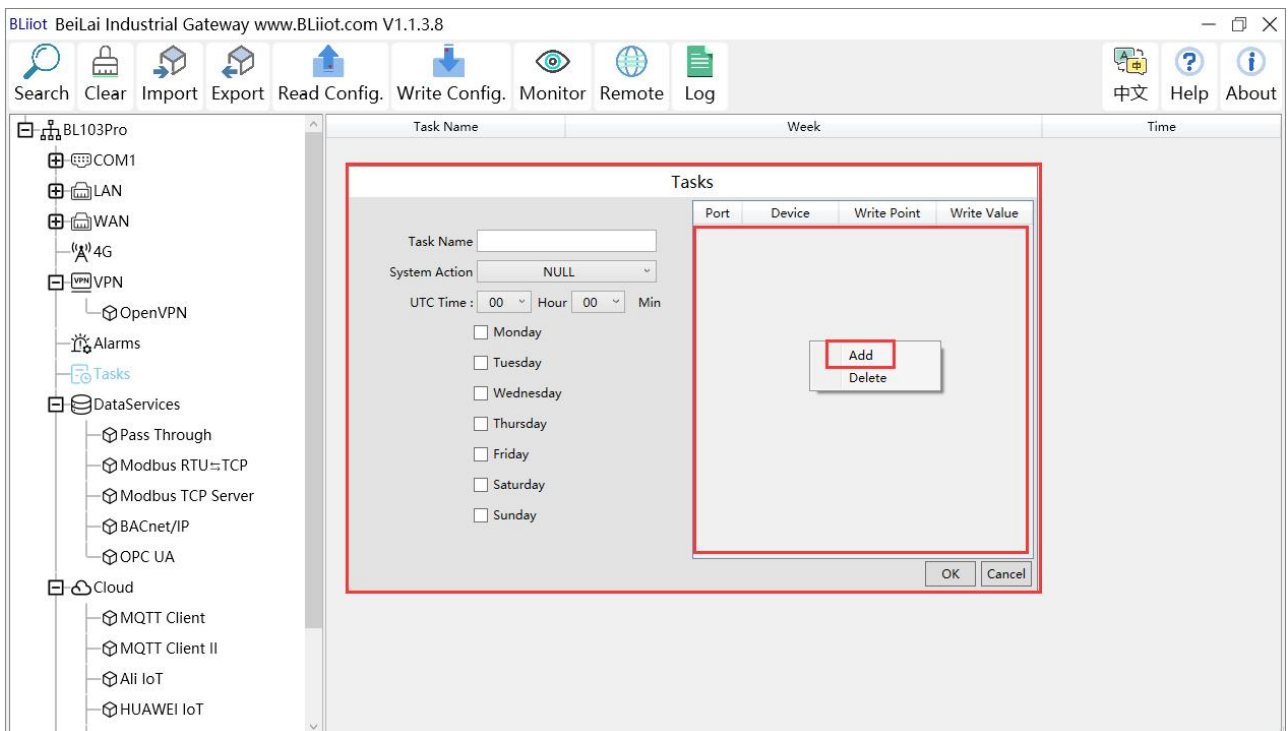
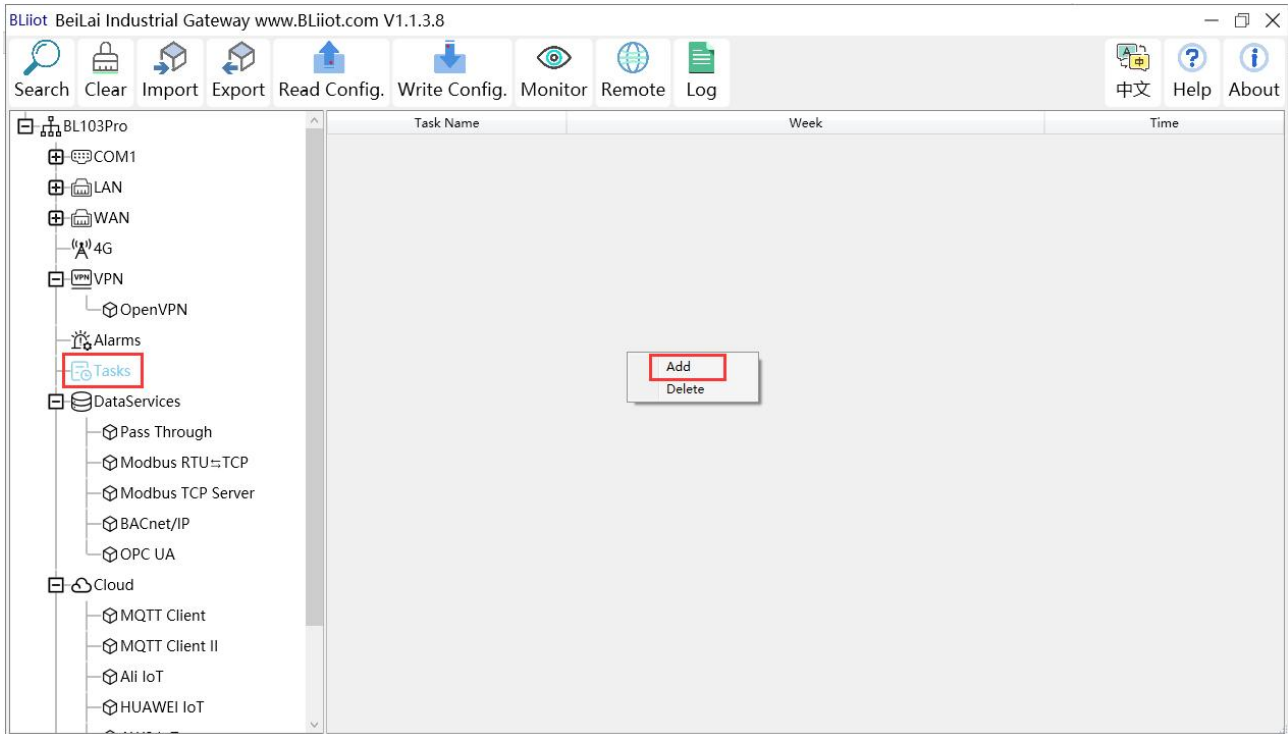

Task Plan Configuration	
Item	Description
Task Name	Name of Task Plan
System Action	Can set to restart the gateway device on a scheduled time. If it is to schedule other actions, select "NULL" for this item.
UTC Time	Set the time for task scheduling, this time is UTC time.
Week	Set week day to perform the planned task
Write Point Name	Generate the point name according to the selected data point,

	click "Add" to select the data point to be operated. Click on the data point and click OK
Write Value	Write the value of the data point to be operated, write "1" or "0" for Boolean, "0" means open, "1" means close.
OK	Confirm Task Plan setting
Cancel	Cancel Task Plan setting

4.2.10 Data Service

4.2.10.1 Transparent Transmission

Set COM mode to Transparent Transmission, set COM parameters and then configure Transparent Transmission parameters

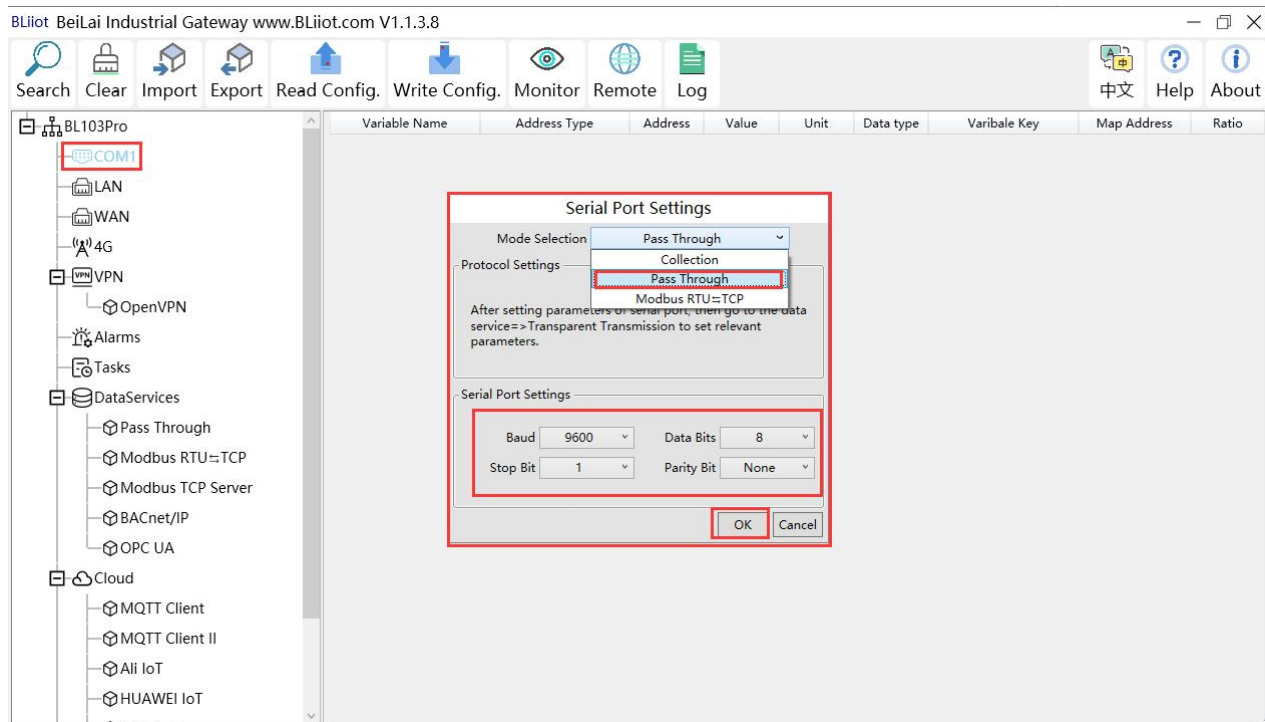

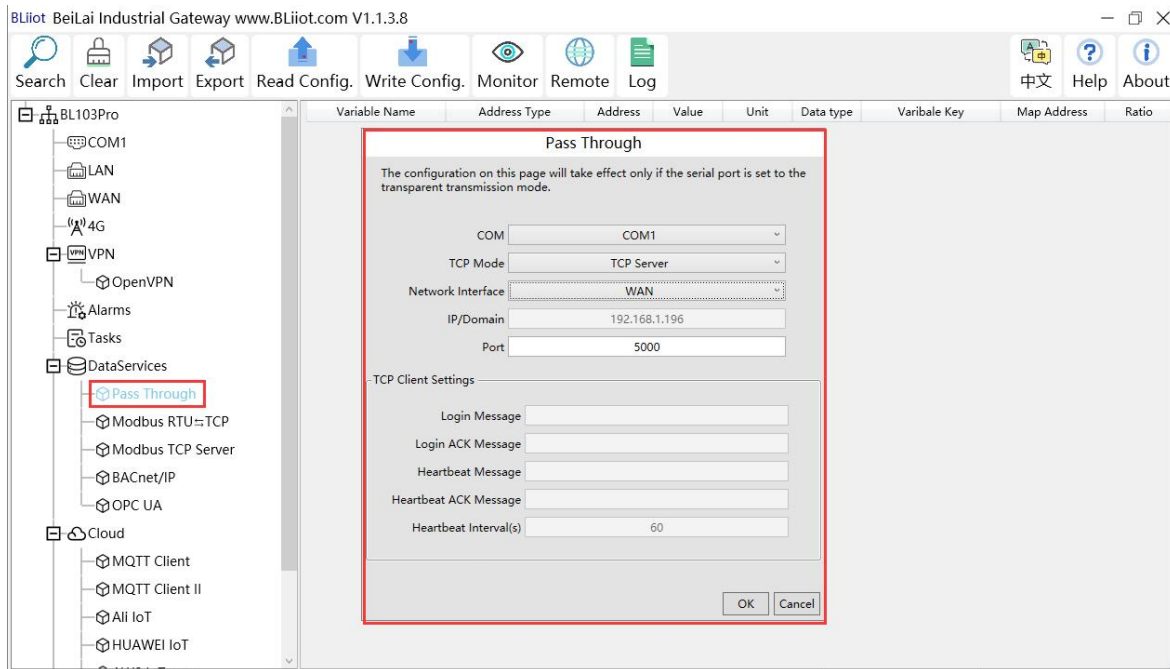

Transparent Transmission Configuration

Item	Description
COM	For example COM1
TCP Mode	Select Gateway as “TCP Server” or “TCP Client”
Network Interface	Only set it when BL102 Gateway is used as TCP server Select WAN or LAN
IP /Domain Name	If BL102 is used as server, it can't be set but automatically show selected WAN or LAN IP If BL102 is used as client, fill in transparent transmission server IP
Port	If BL102 is used as server, fill in monitoring port If BL102 is used as client, fill int server port
Login Message	Data Package of logging in to server, filled in when the gateway device acts as a client.
Login ACK Message	Data Package of server response to login, filled in when the gateway device acts as a client.
Heartbeat Message	Heartbeat Data Package to keep connection, filled in when the gateway device acts as a client.
Heartbeat ACK Message	Data Package of server response to heartbeat, filled in when the gateway device acts as a client.
Heartbeat Interval	Cycle time of sending heartbeat package. Default is 60s, filled in when the gateway device acts as a client.
OK	Confirm Transparent Transmission setting
Cancel	Cancel Transparent Transmission setting

4.2.10.2 Modbus RTU to Modbus TCP

Set COM mode to Modbus RTU to Modbus TCP, set COM parameter and then configure Modbus RTU to Modbus TCP parameters in Data Service

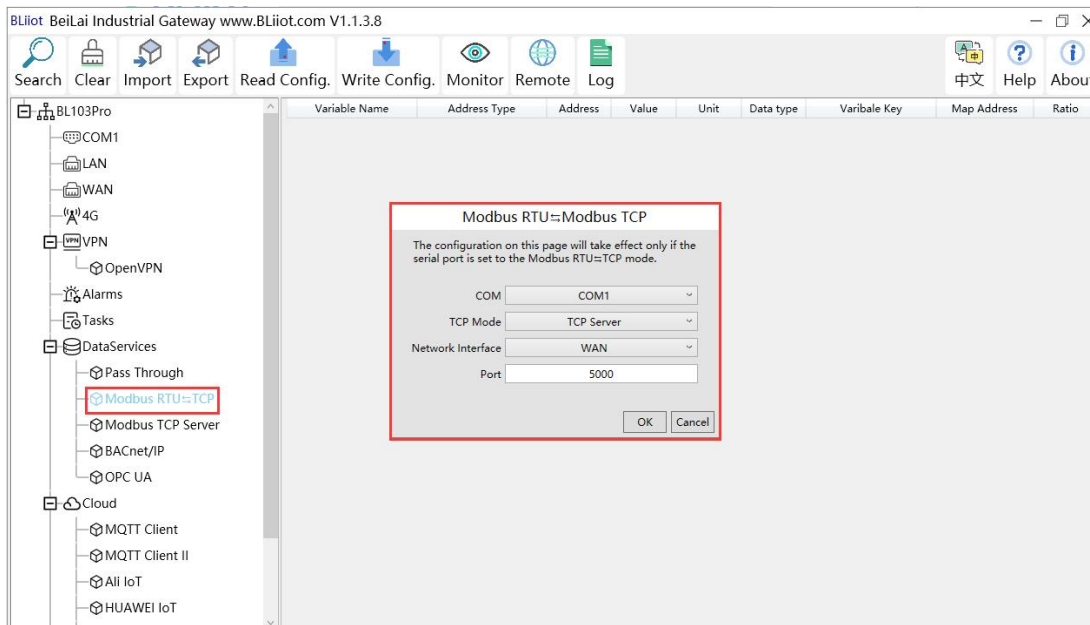
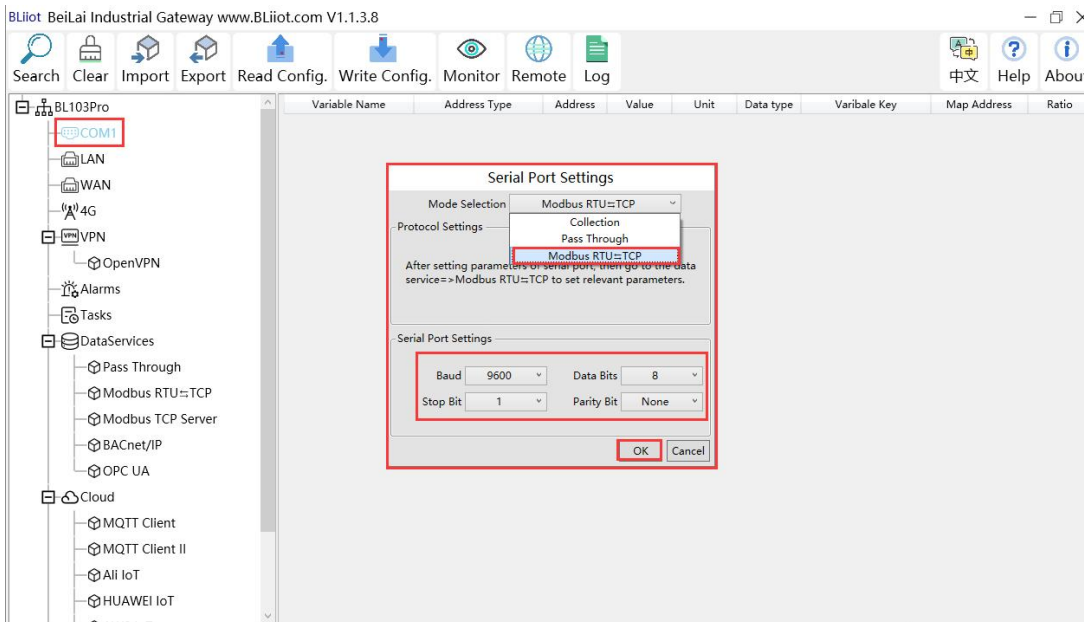

Modbus RTU to Modbus TCP Configuration	
Item	Description
COM	COM1
TCP Mode	TCP Server (Gateway can only be TCP Server)
Network Interface	Select "WAN" or "LAN"
Port	Fill in port of monitoring BL102 Gateway (required)
OK	Confirm Modbus RTU to Modbus TCP configuration
Cancel	Cancel Modbus RTU to Modbus TCP configuration

4.2.10.3 Modbus TCP Server

BL102 Gateway supports Modbus TCP protocol and provides data as Modbus TCP server. Modbus TCP server is enabled permanently. Only configure Ethernet port and monitoring port. The IP address of the Modbus TCP server can be selected according to the requirements of WAN or LAN. WAN /LAN IP address can be viewed by clicking WAN/LAN

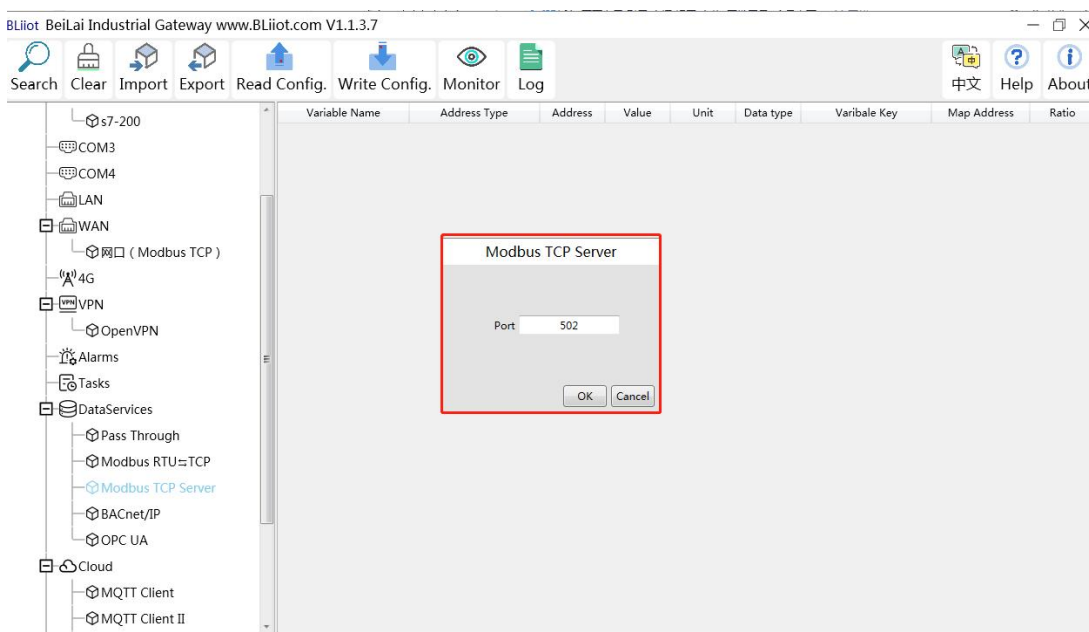

Modbus TCP Server Configuration	
Item	Description
Ethernet Port	Select "WAN" or "LAN"
Port	Fill in gateway monitoring port (required)
OK	Confirm Modbus TCP Server setting
Cancel	Cancel Modbus TCP Server setting

Modbus TCP master computer is used as client to collect function codes supported by Gateway data. Boolean data supports 01, 05, numerical data supports 03, 06, 16-bit byte sequence is AB and 32-bit bytes sequence is ABCD. Follow master computer to put Modbus address or PLC Modbus address (The outside of the mapping address on the configuration software represents the Modbus address, and M.XXX in the brackets represents the PLC Modbus address.). Refer to below datapoint picture. Master computer configuration refers to [5.4.2View and Send Command with KingView](#)

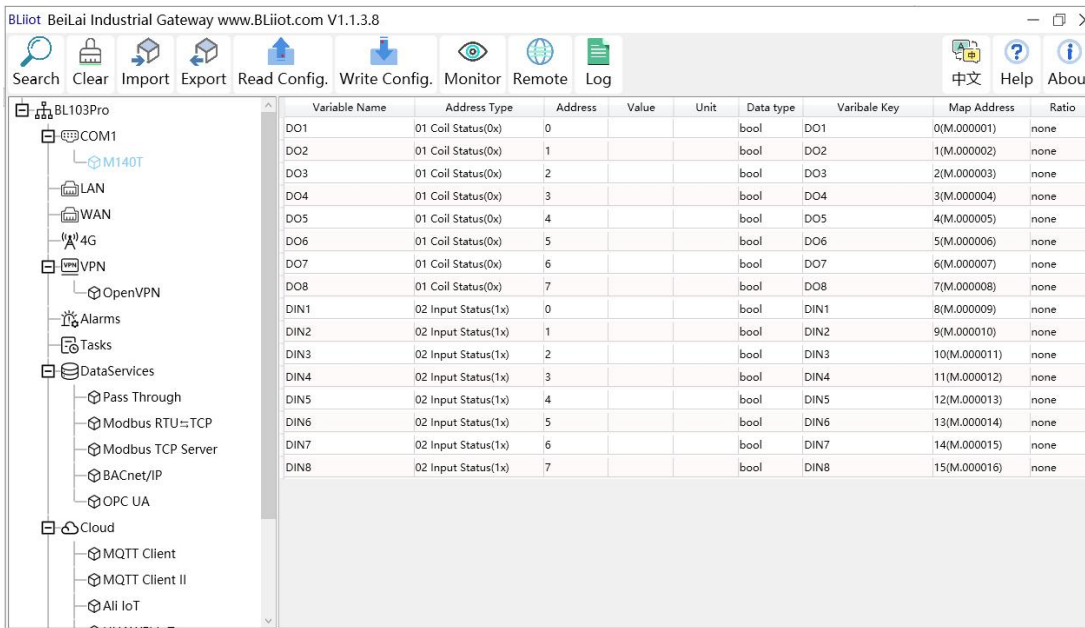

4.2.10.4 OPC UA

Gateway BL102 supports OPC UA and provides data as OPC UA server.

The IP address of the OPC UA server can be selected according to the requirements of WAN or LAN. WAN/LAN IP Address can be viewed by clicking WAN LAN

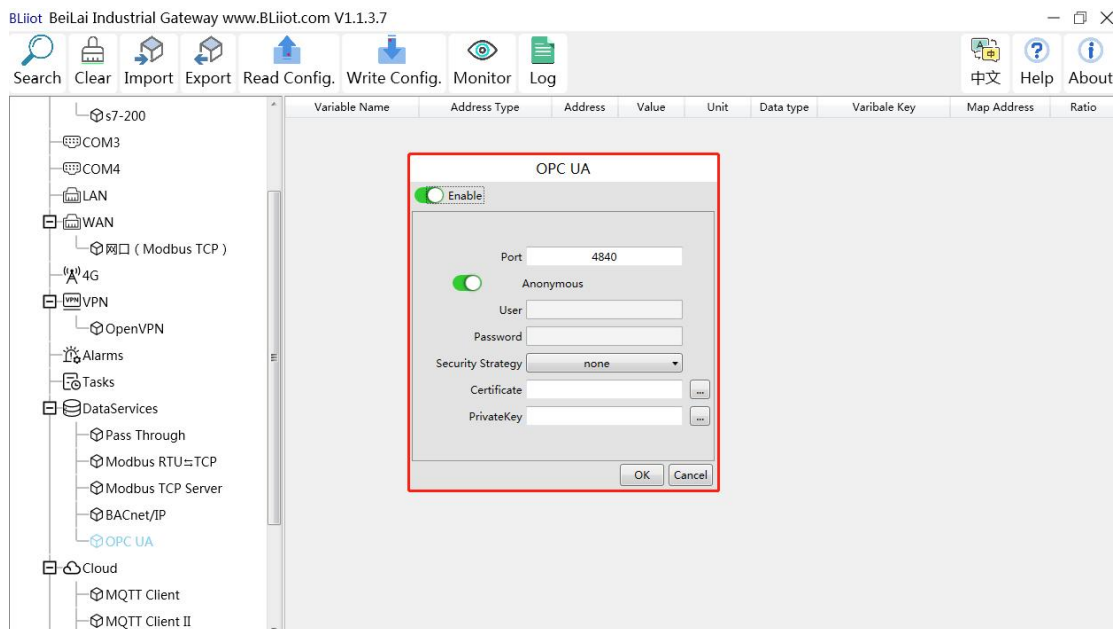

OPC UA Configuration	
Item	Description
Enable	Green indicates OPC UA is enabled Gray indicates OPC UA is disabled. Default is disabled
Port	Fill in the server port, the port must be filled in. Default: 4840

Anonymous	Disable by default. Gray: Enabled, Green: Disabled.
User	Fill in the user name
Password	Fill in User Password
Security strategy	Encryption policy. Select "none", "basic256", "basic128rsa15" or "basic256sha256"
Certificate	OPC UA certificate, select file to upload
PrivateKey	OPC UA encryption key, select file to upload
OK	Confirm OPC UA setting
Cancel	Cancel OPC UA setting

Refer to [5.4.4View and Send Command with UaExpert](#) for OPC UA Client configuration
 OPC UA Client datapoints are retrieved from gateway and automatically generated. It's not necessary to configure. The name of the data point is composed of the device name on the configuration software and the variable name, and the Node id is composed of the device name on the configuration software and the data point label of the device.

4.2.11 Cloud Platform

Gateway BL102 can be online simultaneously in multiple cloud platforms.

4.2.11.1 MQTT Client

MQTT Client can be connected to cloud with certificate or without certificate.

MQTT Client data format only supports JSON data format of "KingPigeon", "thingsboard", and "sparkplug b". MQTT data format can be customized. More JSON data format and customized JSON data format will be supported in the future.

Connect to the ThingsBoard platform, select JSON data format of "thingsboard-telemetry-gateway". ThingsBoard platform domain name is thingsboard.cloud.

Connect to a platform that supports Sparkplug B, such as the ignition, select the JSON data format of "sparkplug b", click the button next to the data template item, configure the group ID and edge node ID in the configuration box.

MQTT Client supports multiple publishing topics, click "Add" in the publishing topic item to fill in the publishing topic, and you can view the publishing topic name in the drop-down box of the publishing topic item. Select the release topic name and click "Delete" to delete the release topic to be deleted. MQTT Client also supports the selection of different data points for each publishing topic to publish. Put the mouse cursor in the right box, click the right button, a prompt box will pop up, click "Add", a data point box will pop up, click the data point to be published, Click "OK". Double-click a data point to view the properties. As shown in the figure below: The publishing topic "topic" only publishes the

data point "DO1" of the "M140T" device of "COM1", and other data points are not published.

The "KingPigeon" JSON data format of MQTT Client and MQTT Client II is the same as that of KingPigeon MQTT. Refer to: [5.4.19 King Pigeon MQTT Data Format](#).

"thingsboard-telemetry-gateway" JSON data format, publish and subscribe topic format refer to the thingsboard official website documentation.

"sparkplug b" JSON data format, publish and subscribe topic format refer to Sparkplug specification
 Note: The data point box is blank by default, if no data point is selected, all data points are published.
 If there are multiple publishing topics, only one publishing topic can be blank, and other topics must select the published data points, and cannot be left blank.

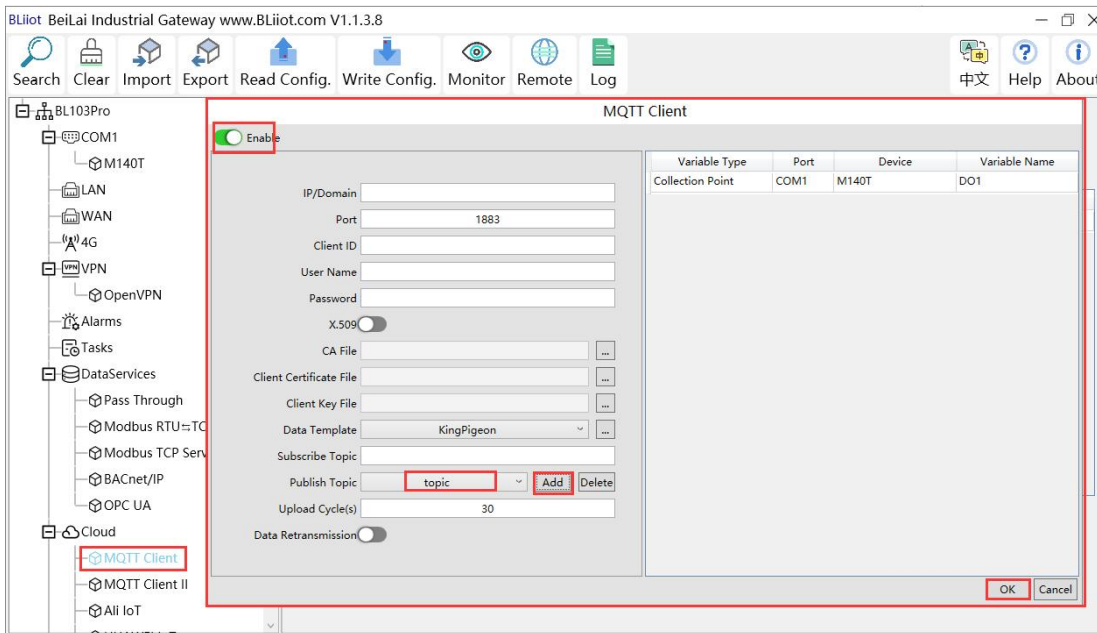

MQTT Client One Configuration	
Item	Description
Enable	Green indicates MQTT Client One is enabled Gray indicates MQTT Client One is not enabled.
IP/ Domain Name	Fill in Server IP/Domain name
Port	Fill in server port(required), default is 1883
Client ID	Client Identifier of MQTT Connecting message. Server uses it to identify Client
User Name	User Name of MQTT Connecting message. Server uses it for ID verification and authorization
Password	Password of MQTT Connecting message Server uses it for ID verification and authorization
X.509 (Enable Certificate)	Green indicates certificate is enabled Gray indicates certificate is not enabled
CA Certificate	Select file to upload (Need enable Certificate first)

Client Certificate File	Select file to upload (Need enable Certificate first)
Client Key File	Select file to upload (Need enable Certificate first)
Data template	Json data format selection, choose from "KingPigeon", "thingsboard-telemetry-gateway", "sparkplug b", "yundee", "dl". Default: KingPigeon. Some data templates have special configuration, click the button next to it to configure, such as the group ID and edge node ID of the "sparkplug b" template
Subscribe Topic	Topic of MQTT subscribing message. After subscribing server can send message to client for controlling
Publish Topic	Topic of MQTT publishing message. It's used for MQTT to identify message channel of sending valid load data. Wildcard can't be included in publishing message topic name. Click Add to add more public topics. Click Delete to delete Public Topic
Uploading Cycle	Cycle time of MQTT data sending. Default is 30s
Data Re-transmission (Enable data re-transmission)	Green indicates offline data will be transmitted once network recovers; Gray indicates offline data will not be transmitted once network resumes. Max 100,000 datapoints can be re-transmitted. If more than that, the previous ones will be deleted
Selection of published data points	Default is blank, means all data uploaded. In the box on the right, click the right mouse button, click "Add", the data point box will pop up, click the data point, and click OK.
OK	Confirm MQTT Client One setting
Cancel	Cancel MQTT Client One setting

4.2.11.2 MQTT Client II

[MQTT Client II Configuration is the same as MQTT Client](#)

[MQTT Client II configuration refer to 4.2.11.1MQTT Client](#)

[MQTT Client II subscribe topic will not be working. MQTT Client Two is used for view data but not control data from cloud.](#)

[MQTT Client II and MQTT Client"KingPigeon"JSON data format is the same as that of King Pigeon](#)

[MQTT. Refer to 5.4.9 King Pigeon Cloud MQTT Data Format](#)

4.2.11.3 Alibaba Cloud

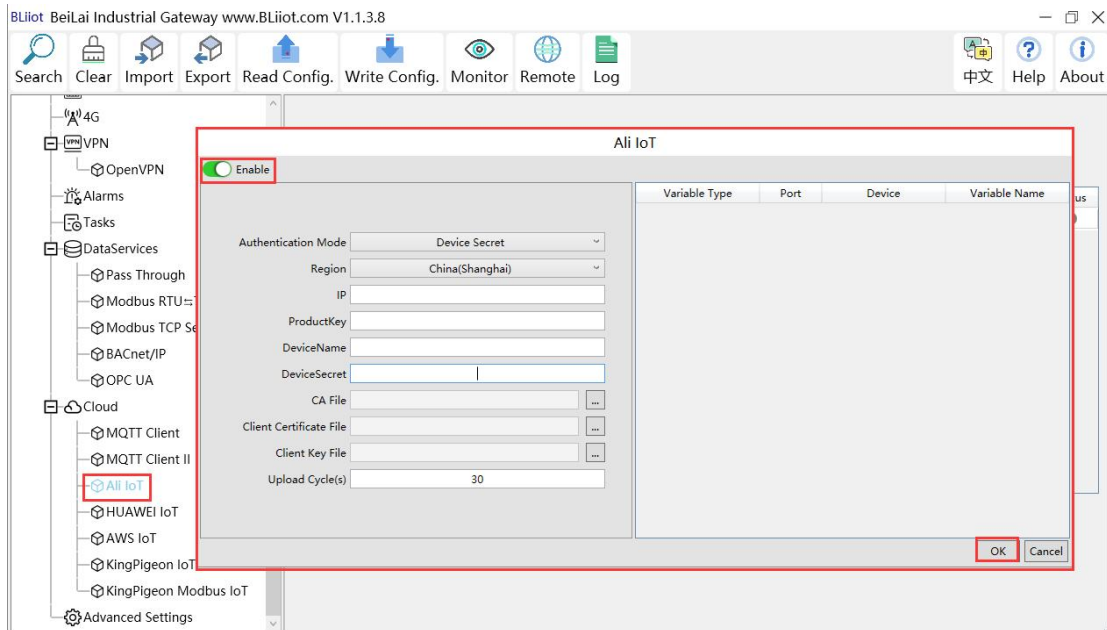

Alibaba Cloud Configuration	
Item	Description
Enable	Green indicates Alibaba Cloud is enabled Gray indicates Alibaba Cloud is not enabled. Default is disabled
Authentication Mode	Default is key connection. Select the key or certificate according to your needs, and choose from "Device Secret" and "X.509".
Region	Select Alibaba Cloud Region, default is China(Shanghai)
IP	The IP address of Alibaba Cloud Enterprise Edition, not required for the public edition.
ProductKey	Set the same ProductKey as the one in Ali Cloud. See below illustration (Device-Click DeviceSecret to view it)
DeviceName	Set the same DeviceName as the one in Ali Cloud See below illustration (Device-Click DeviceSecret to view it)
DeviceSecret	Set the same DeviceSecret as the one in Ali Cloud See below illustration (Device-Click DeviceSecret to view it)
CA Certificate	Select File Upload(Select Certificate Connection to fill in)
Client Certificate File	Select File Upload(Select Certificate Connection to fill in)
Client Key File	Select File Upload(Select Certificate Connection to fill in)
Uploading Cycle	Cycle time of data sending. Default is 30s
Publish Datapoint Selection	Default is blank box with all datapoints to be uploaded Right click the box and click Add to select datapoint for

	uploading. Click OK to confirm it.
OK	Confirm Alibaba Cloud setting
Cancel	Cancel Alibaba Cloud setting

Alibaba Cloud device model is under development. Thus datapoint must be added one by one. MQTT flag must be the same as the one in configuration software. For example, collect datapoint VW8 of PLC S7-200SMART. MQTT flag in configuration software is VW8. Then set datapoint as VW8 in cloud. Function name can be different from variable name in configuration software.

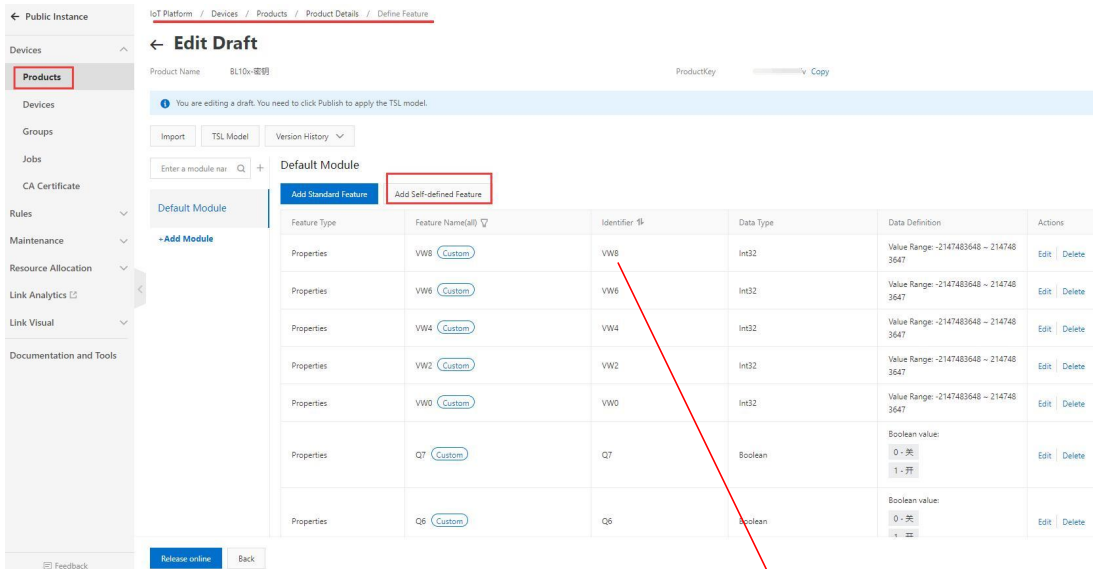
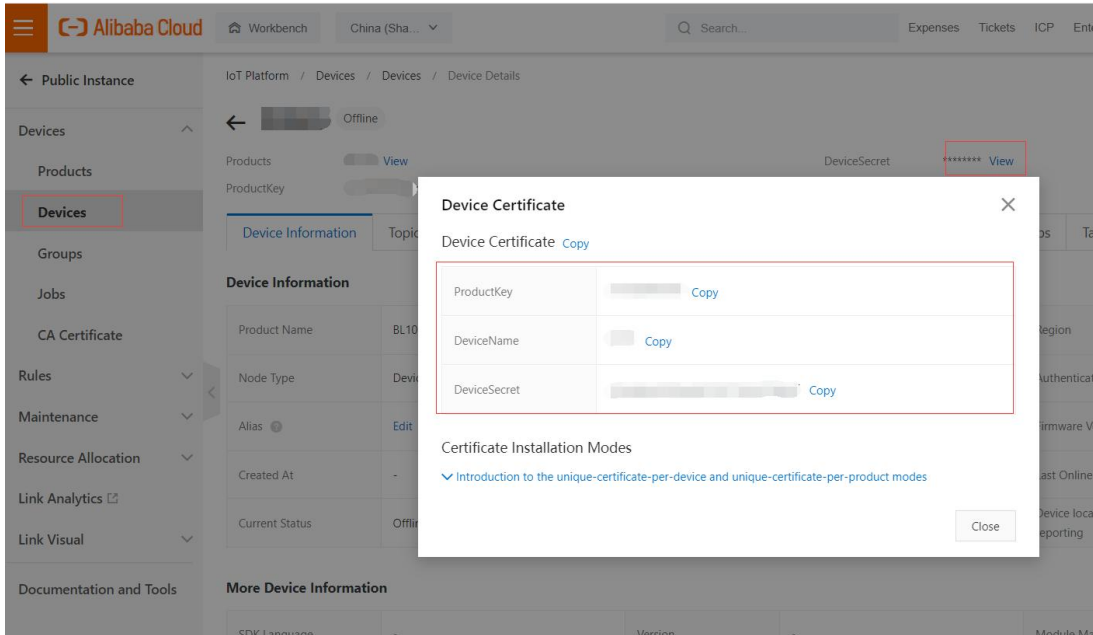

Variable Name	Address Type	Address	Value	Unit	Data type	Variable Key	Map Address	Ratio
Q0.0	Q	0			bool	Q0	0(M.000001)	none
Q0.1	Q	0.1			bool	Q1	1(M.000002)	none
Q0.2	Q	0.2			bool	Q2	2(M.000003)	none
Q0.3	Q	0.3			bool	Q3	3(M.000004)	none
Q0.4	Q	0.4			bool	Q4	4(M.000005)	none
Q0.5	Q	0.5			bool	Q5	5(M.000006)	none
Q0.6	Q	0.6			bool	Q6	6(M.000007)	none
Q0.7	Q	0.7			bool	Q7	7(M.000008)	none
VW0	VW	0			uint16	VW0	0(M.400001)	1
VW2	VW	2			uint16	VW2	1(M.400002)	1
VW4	VW	4			uint16	VW4	2(M.400003)	1
VW6	VW	6			uint16	VW6	3(M.400004)	1
VW8	VW	8			uint16	VW8	4(M.400005)	1

Note: Currently Alibaba cloud device shadow is not supported. Data is written through online debugging. Multiple data sending is not supported.

4.2.11.4 HUAWEI Cloud

HUAWEI Cloud can be connected with or without Certificate. It supports multiple service IDs. Click Add to set Service ID. ID can be viewed from the drop-down list. Click Delete to delete service ID. HUAWEI Cloud supports uploading certain datapoints of each Service ID. Right click the box and click Add to enter datapoint dialog box. Select the datapoint to upload and click OK to confirm it. Double click the datapoint to view its attributes.

Note: 1. Datapoint box is blank in default which means all datapoints will be uploaded. If there're multiple Service IDs, only one Service ID datapoint box can be blank. Datapoints for uploading must be selected for other Service IDs.

2. HUAWEI Cloud device shadow function is not supported. Data is written through synchronization command.

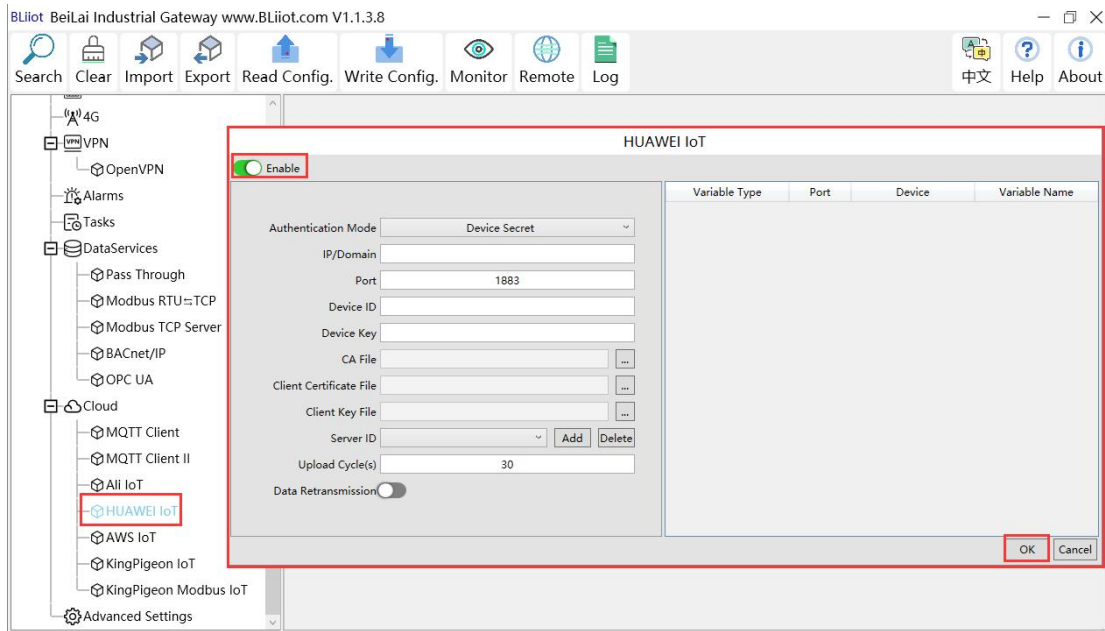

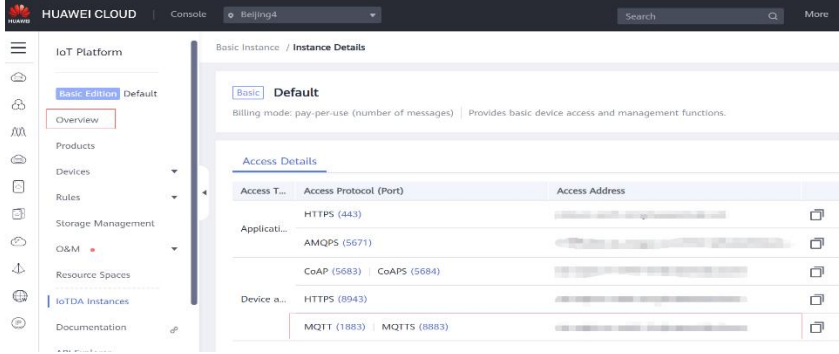
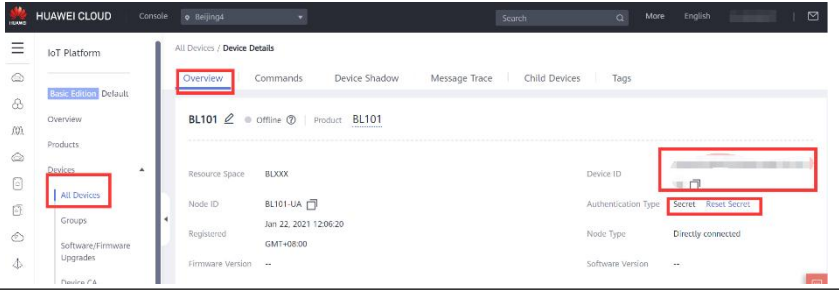
HUAWEI Cloud Configuration	
Item	Description
Enable	Green indicates HUAWEI Cloud is enabled. Gray indicates HUAWEI Cloud is disabled. Default is disabled
Authentication mode	Default is key connection. Select the key or certificate according to your needs, and choose from "Device Secret" and "X.509".
IP/ Domain Name	Select connecting to HUAWEI Cloud via MQTT to enter console. Click Overview to get server IP address of device connection 
Server Port	Default is 1883, fill in 1883 for connecting with Secret Key fill in 8883 for connecting with Certificate (Required)
Device ID	Set the same ID as the one in HUAWEI Cloud(Device-Device ID) 
Device Secret	Set the same Device Secret Key as the one in HUAWEI Cloud

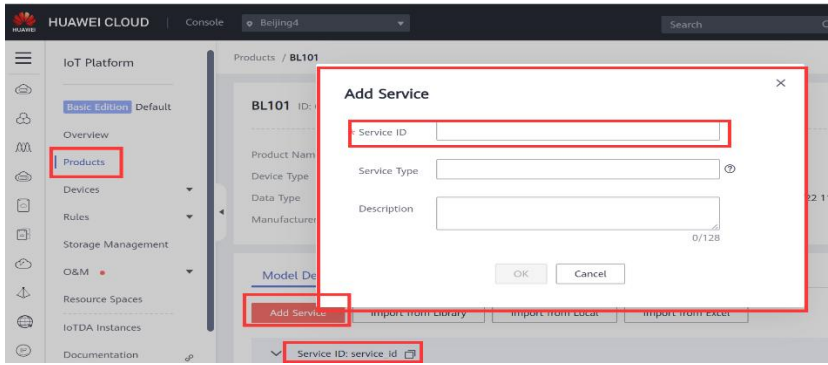
Key	<p>when creating device in HUAWEI Cloud. If it's forgot, it can be reset in device authentication.</p> <p>(Not necessary if connecting with certificate is selected)</p>
CA File	Select File Upload(Select Certificate Connection to fill in)
Client Certificate	Select File Upload(Select Certificate Connection to fill in)
Client Key File	Select File Upload(Select Certificate Connection to fill in)
Service ID	<p>Set the same Service ID as the one in HUAWEI Cloud. (IOT Platform-Products-Add Service-Service ID)</p>  <p>Multiple Service IDs are supported</p>
Upload Cycle	Cycle time of data uploading. Default is 30s
Data Re-transmission	Green indicates offline data will be transmitted once network recovers; Gray indicates offline data will not be transmitted once network resumes. Max 100000 datapoints can be re-transmitted. If more than that, the previous ones will be deleted.
Datapoint Uploading Selection	<p>Default is blank box with all datapoints to be uploaded</p> <p>Right click the box and click Add to select datapoint for uploading. Click OK to confirm it.</p>
OK	Confirm HUAWEI Cloud setting
Cancel	Cancel HUWEI Cloud setting

Set datapoint in HUAWEI Cloud as below picture. If there're multiple service IDs in configuration software and each service ID has different datapoints, configure the same service ID in HUAWEI Cloud. Put MQTT flag as attribute name. For example, collect datapoint Q0 of PLC S7-200SMART, put configuration software MQTT flag Q0 as attribute name.

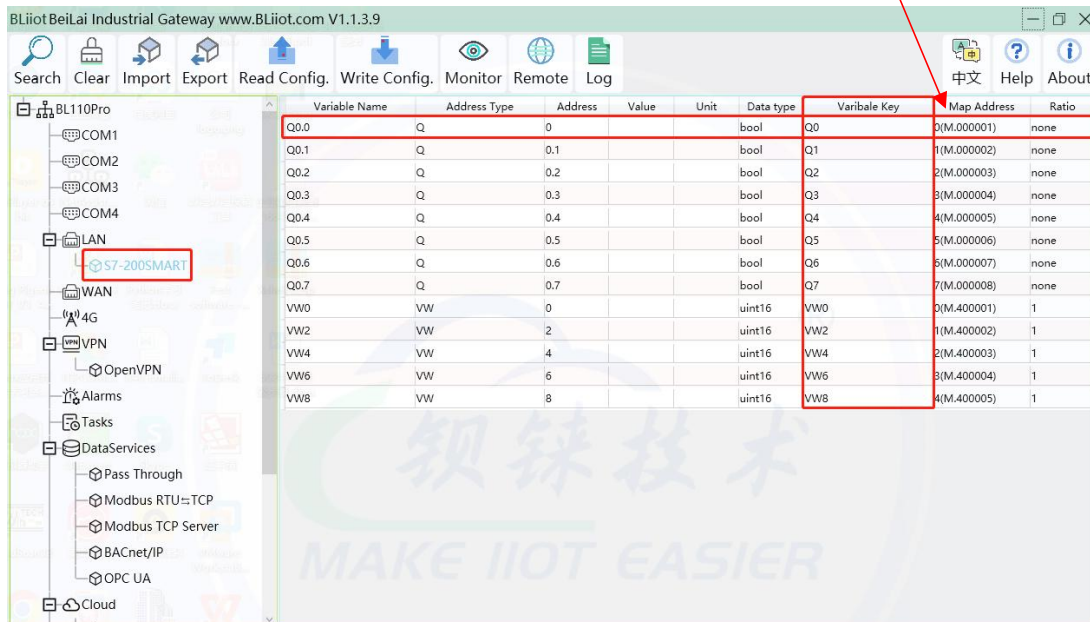
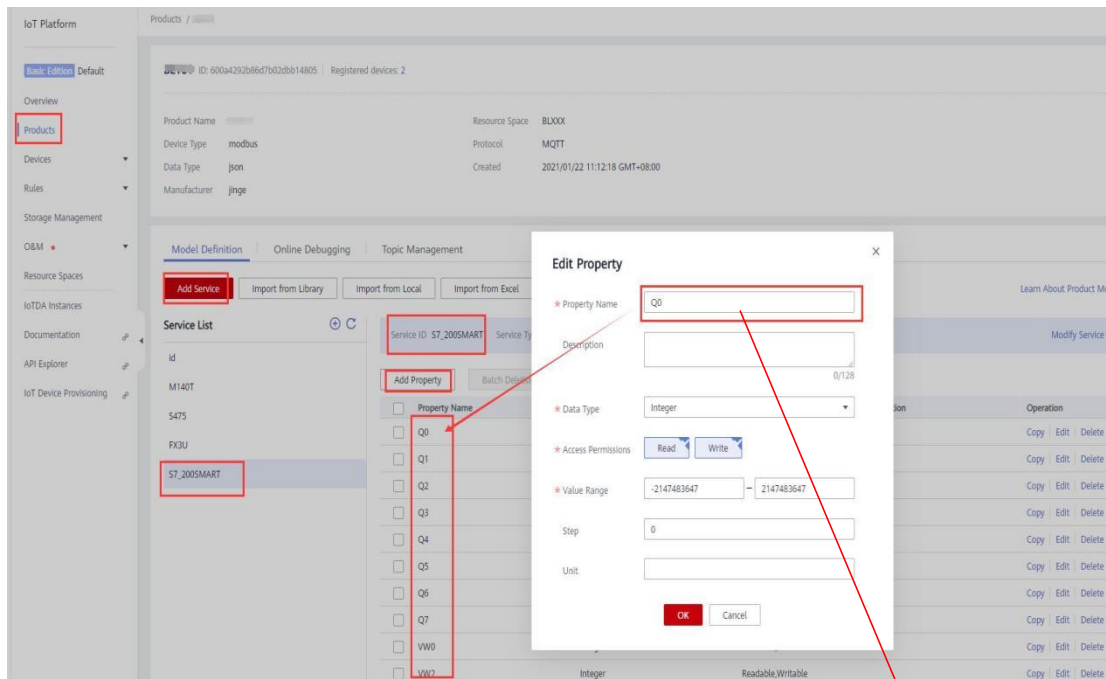

4.2.11.5 AWS Cloud

1. Datapoint box is blank in default which means all datapoints will be published. If multiple topics are published, only one topic datapoint box can be blank. For other topics, datapoints for publishing must be selected.
2. AWS Cloud data writing function is not supported

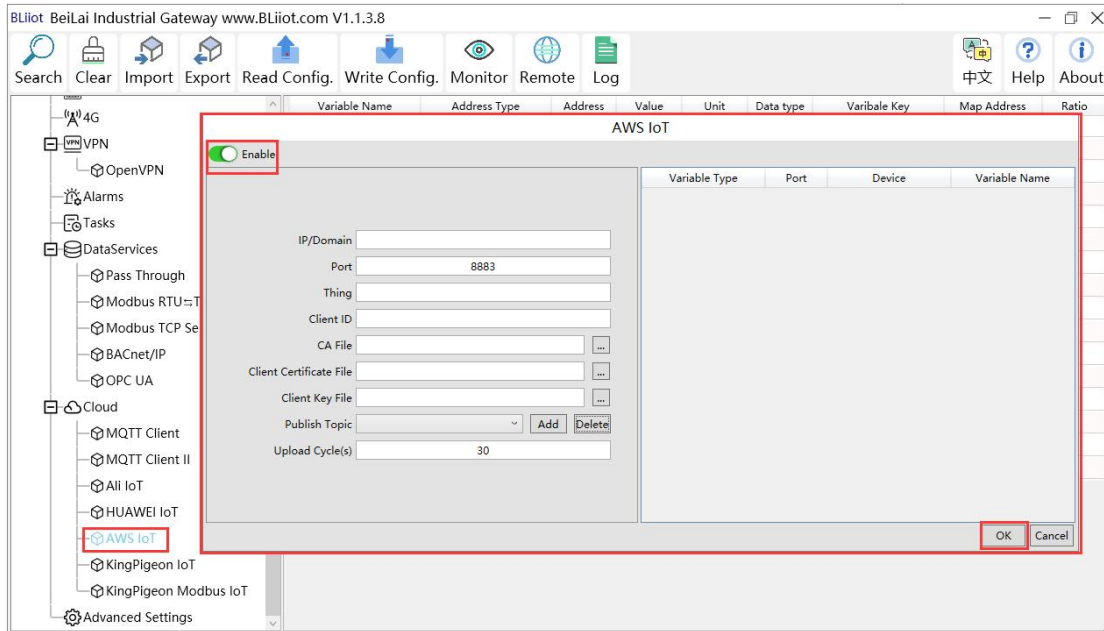

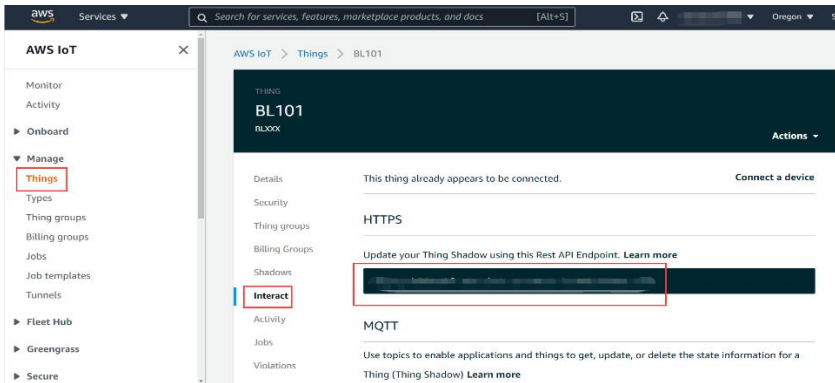
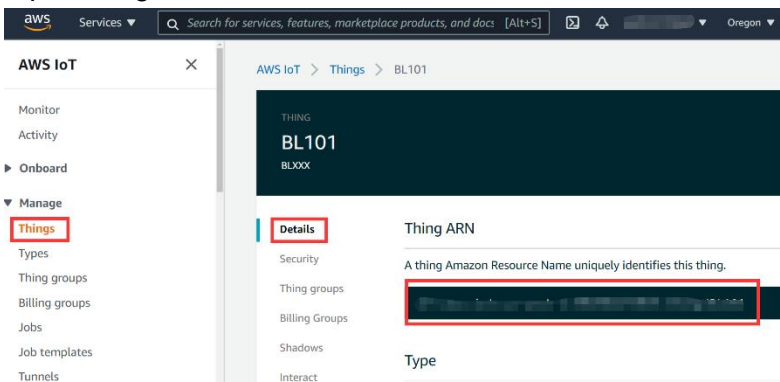
AWS Configuration	
Item	Description
Enable	Green indicates AWS is enabled. Gray indicates AWS is disabled. Default is disabled
IP/ Domain Name	Fill in the terminal node, enter the console, and click "Things" - "Interact". 
Server Port	8883 (Required)
Things	Input Thing ARN 
Client ID	Fill in AWS Account ID

CA File	Select File Upload
Client certificate file	Select File Upload
Client key file	Select File Upload
Publish Topic	<p>Topic created when creating a rule, topic name used by MQTT to publish messages, click "Add" to fill in the published topic name. Click Add to create more Publish Topics. Select Publish Topic and click Delete to delete it.</p>
Upload Cycle	Cycle time of data uploading. Default is 30s
Datapoint Publishing Selection	Default is blank box with all datapoints to be published Right click the box and click Add to select datapoint for publishing. Click OK to confirm it. .
OK	Confirm AWS setting
Cancel	Cancel AWS setting

4.2.11.6 King Pigeon Cloud via MQTT

King Pigeon Cloud MQTT data format refer to: [King Pigeon Cloud MQTT Data Format](#)

Configure it as below picture :

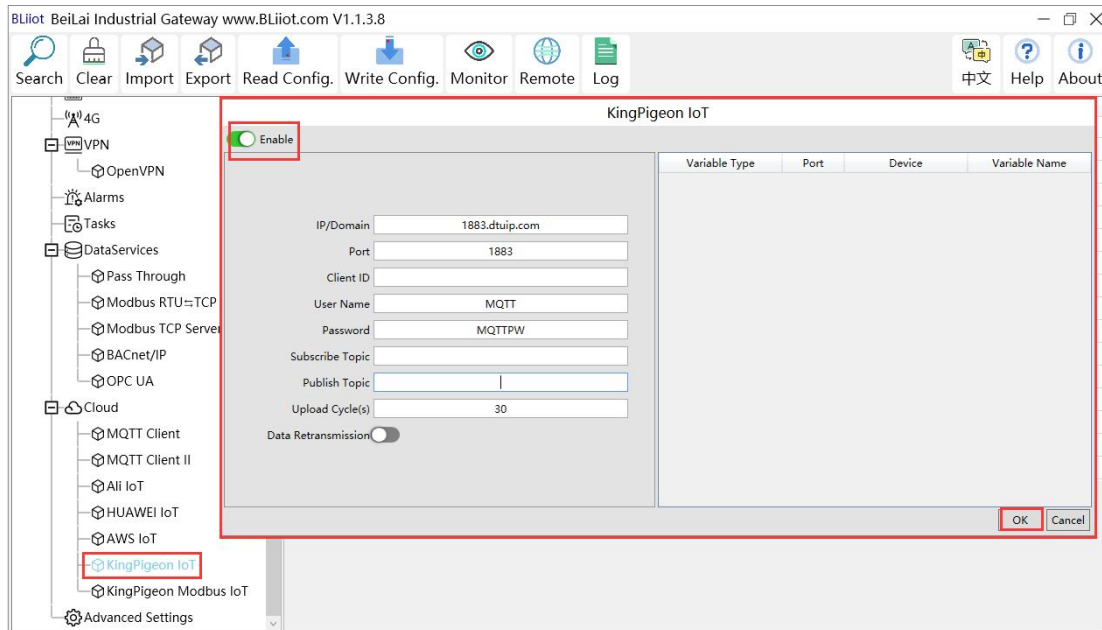

King Pigeon Cloud via MQTT Configuration	
Item	Description
Enable	Green indicates King Pigeon cloud via MQTT is enabled Gray indicates King Pigeon cloud via MQTT is disabled
IP/Domain Name	1883.dtuip.com
Port	1883(Required)
Client ID	Fill in device serial number issued by King Pigeon (Contact BLIIoT sales to get the serial number if required to connect to King Pigeon cloud)
User Name	MQTT
Password	MQTTPW
Subscribe Topic	King Pigeon Device Serial Number/+
Publish Topic	King Pigeon Device Serial Number
Upload Cycle	Cycle time of data uploading. Default is 30s
Data Retransmission	Green indicates offline data will be transmitted once network recovers; Gray indicates offline data will not be transmitted once network resumes. Max 100, 000 datapoints can be retransmitted. If more than that, the previous ones will be deleted
Publishing Datapoint Selection	Default is blank box with all datapoints to be published Right click the box and click Add to select datapoint for publishing. Click OK to confirm it.
OK	Confirm King Pigeon Cloud via MQTT setting
Cancel	Cancel King Pigeon Cloud via MQTT setting

Configure datapoint with below procedure. First add datapoint and then configure datapoint mark. It must be the same as MQTT flag in configuration software. For example, collect datapoint Q1 of PLC S7-200SMART, in configuration software MQTT flag is Q1, then set Q1 as read-write mark in King Pigeon cloud.

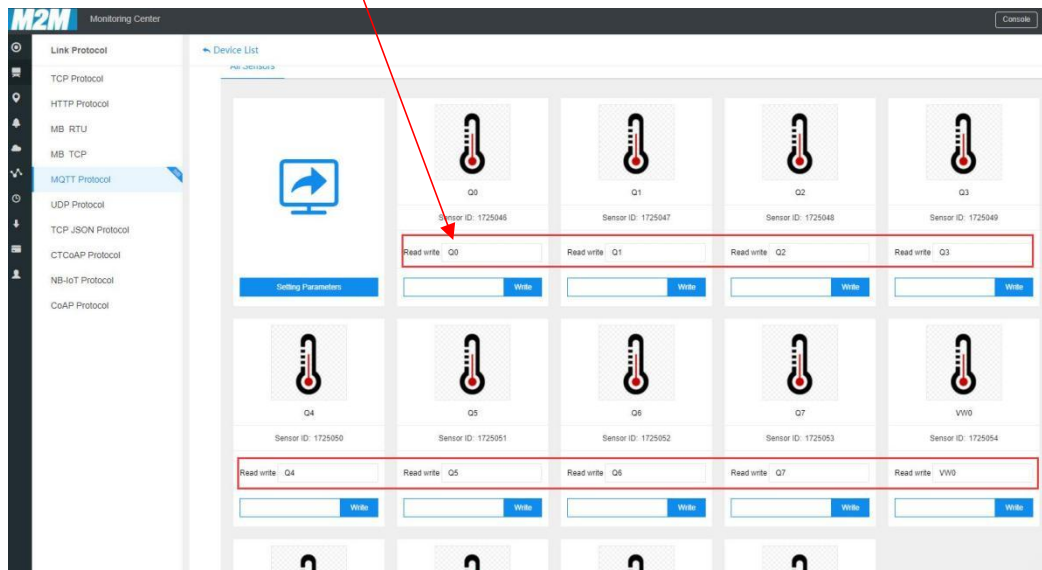
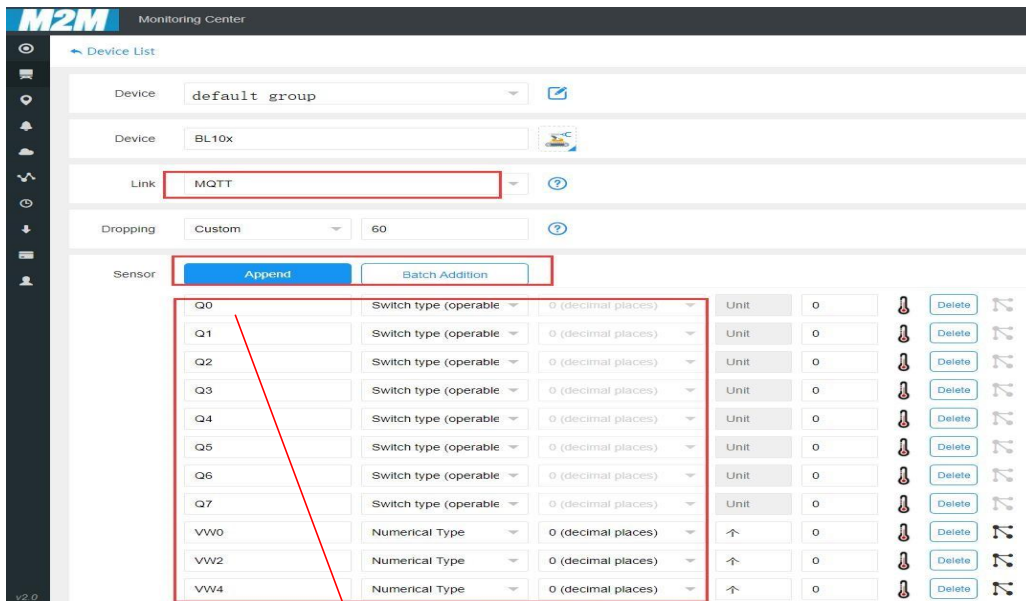

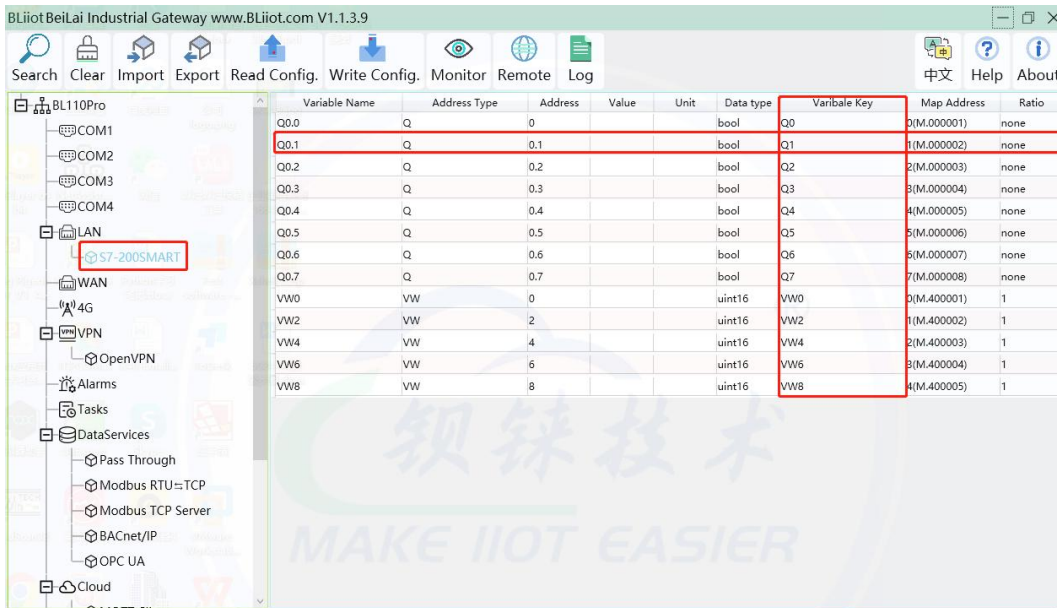

4.2.11.7 King Pigeon Cloud via Modbus

Both King Pigeon Cloud and custom Modbus cloud can be connected via Modbus RTU protocol. BL102 supports function code 01, 05 of Boolean data and function codes 03, 06 of numerical data. 16-bit byte sequence is AB and 32-bit byte sequence is ABCD.

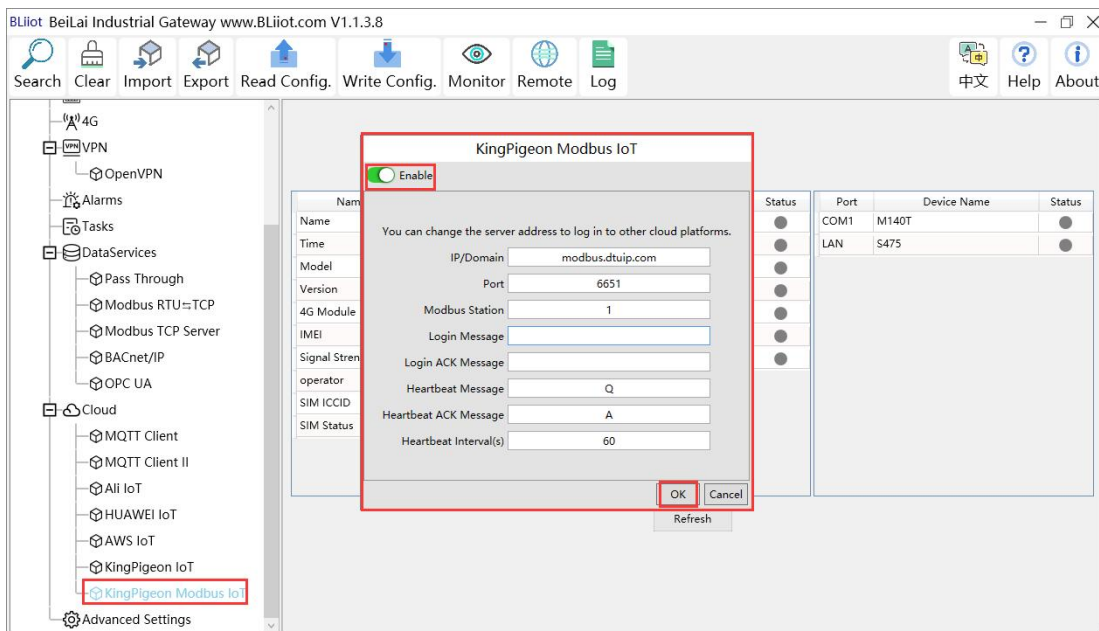

King Pigeon Cloud via Modbus	
Item	Description
Enable	Green indicates King Pigeon Cloud via Modbus is enabled Gray indicates King Pigeon Cloud via Modbus is disabled
IP/Domain Name	modbus.dtuip.com
Port	6651 (Required)

Modbus Station/ID	Set Modbus communication address of this Gateway device
Login Message	Input device serial number issued by King Pigeon (Contact BLIIoT sales to get the serial number)
Login ACK Message	Server acknowledges login messages (Not necessary for King Pigeon Cloud)
Heartbeat Message	Q (Heartbeat message to keep connection)
Heartbeat ACK Message	A (Server acknowledges heartbeat messages)
Heartbeat Interval	Cycle time of sending Heartbeat messages, default is 60s
OK	Confirm King Pigeon Cloud via Modbus setting
Cancel	Cancel King Pigeon Cloud via Modbus setting

Configure datapoint in King Pigeon Cloud as below picture. First create datapoint, then configure Modbus ID, function code, address, data format, byte sequence and data collection cycle. Modbus address in King Pigeon cloud and configuration software is deviated by 1. For example, datapoint Q0 of PLC S7-200SMART in configuration software is 8, then put 9 in cloud. Sensor names in cloud can be different from those in configuration software

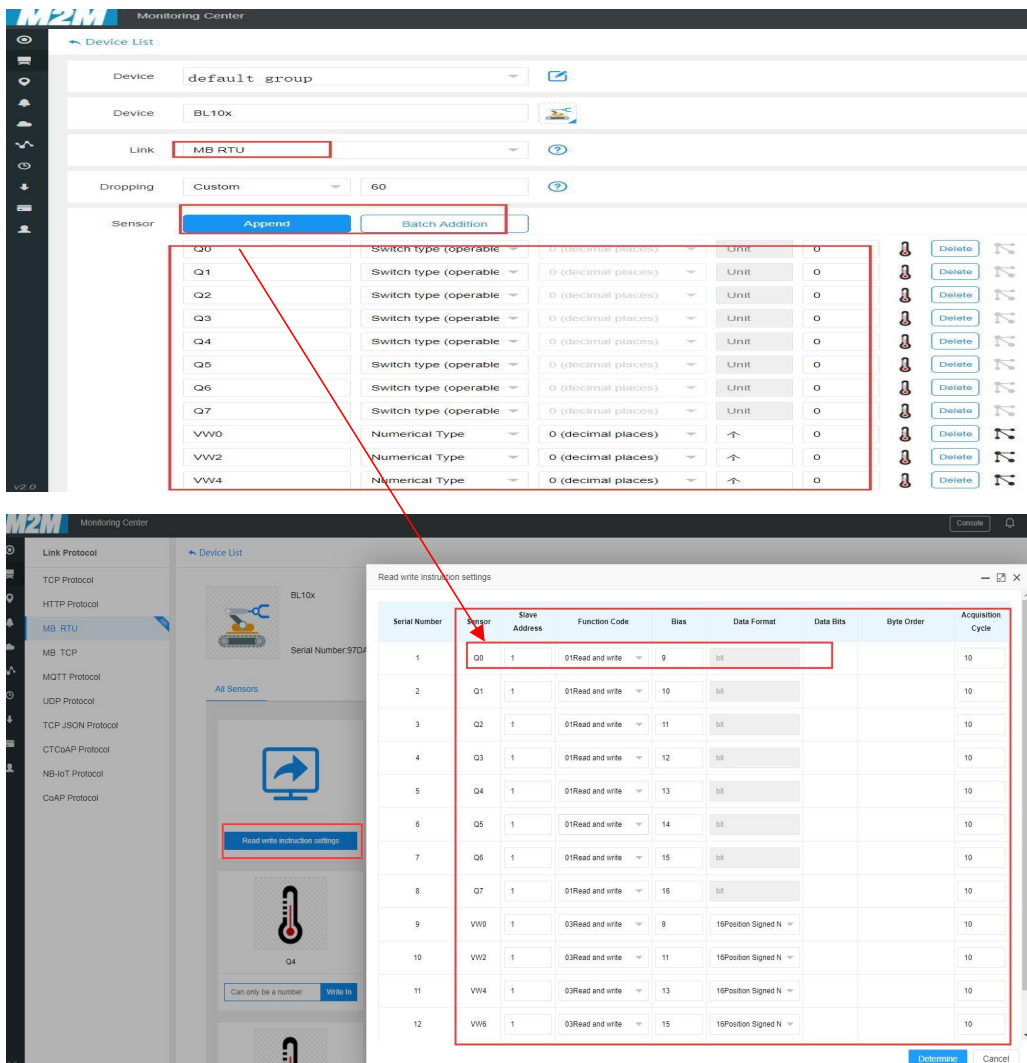

BLIiot BeiLai Industrial Gateway www.BLIiot.com V1.1.3.9

Search Clear Import Export Read Config. Write Config. Monitor Remote Log 中文 Help About

Variable Name	Address Type	Address	Value	Unit	Data type	Variable Key	Map Address	Ratio
Q0.0	Q	0			bool	Q0	0.M.000001	none
Q0.1	Q	0.1			bool	Q1	1.M.000002	none
Q0.2	Q	0.2			bool	Q2	2.M.000003	none
Q0.3	Q	0.3			bool	Q3	3.M.000004	none
Q0.4	Q	0.4			bool	Q4	4.M.000005	none
Q0.5	Q	0.5			bool	Q5	5.M.000006	none
Q0.6	Q	0.6			bool	Q6	6.M.000007	none
Q0.7	Q	0.7			bool	Q7	7.M.000008	none
VW0	VW	0			uint16	VW0	0.M.400001	1
VW2	VW	2			uint16	VW2	1.M.400002	1
VW4	VW	4			uint16	VW4	2.M.400003	1
VW6	VW	6			uint16	VW6	3.M.400004	1
VW8	VW	8			uint16	VW8	4.M.400005	1

5 Gateway BL102 Application Example

5.1 Add Modbus Device

Connect IO Module M140T to BL102 COM port and connect 4G RTU S475 to BL102 LAN port. M140T DI DO data is collected from COM via Modbus RTU protocol. S475 device data is collected from LAN port via Modbus TCP protocol. Connect BL102 WAN port to industrial router R40 LAN port. Router R40 provides network to BL102 Gateway.

5.1.1 Connect M140T & S475 to BL102

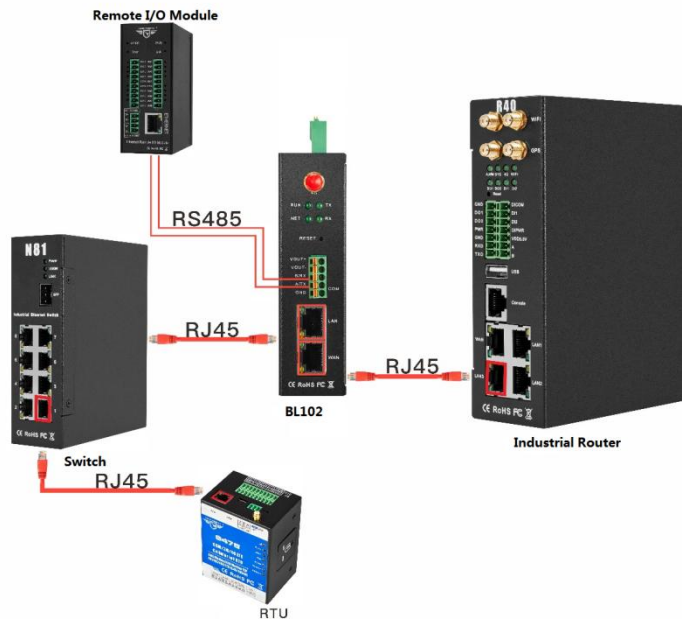

Network Switch N81 is connected to BL102 LAN port. S475 is connected to Switch N81. S475 device data is collected through LAN via Modbus TCP. M140T data is collected through COM via Modbus RTU protocol. Collected data will be sent to various clouds via 4G router R40 with its routing function. Note: Both WAN and LAN can collect device data. The configuration procedure is the same. This example is introduction to LAN port configuration.

5.1.2 COM Port Configuration

5.1.2.1 COM1 Port Configuration

COM1 collect M140T data via Modbus RTU. Below is the configuration.

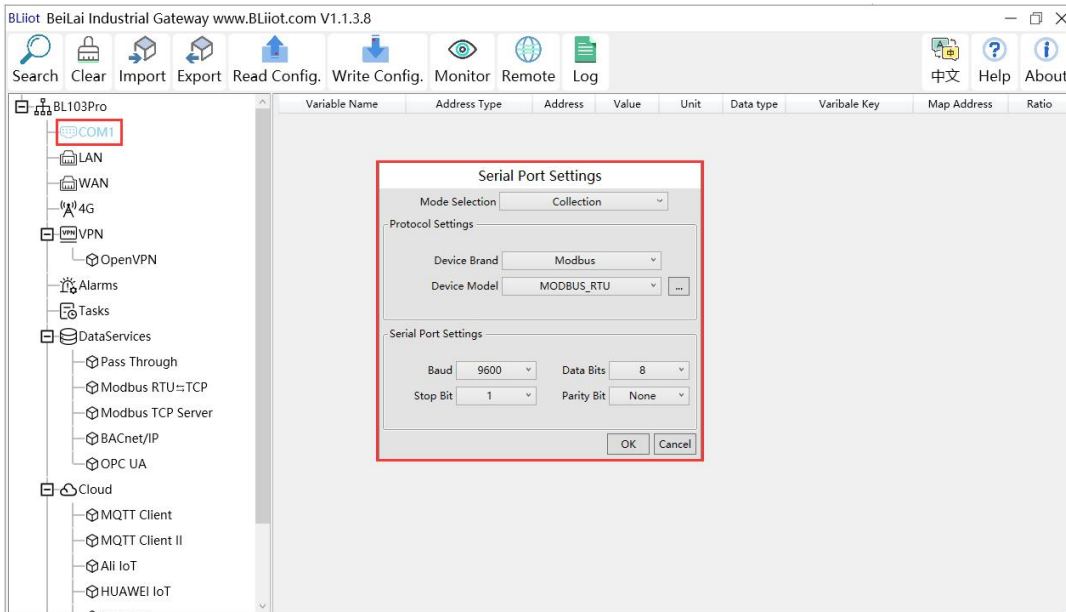

- (1) Double click "COM1" to enter configuration window
- (2) Mode Selection: Collection
- (3) Device Brand: Modbus; Device Model: Modbus RTU The polling interval and timeout are set by default and set according to requirements.
- (4) Baud rate, Stop bit, Data Bit and Parity Bit will be set the same as that in M140T RS485 port
- (5) Click OK to confirm

Note: Click Write Configuration. Gateway will restart automatically. COM configuration will be valid after device restarting

5.1.2.2 Add COM Port Device M140T

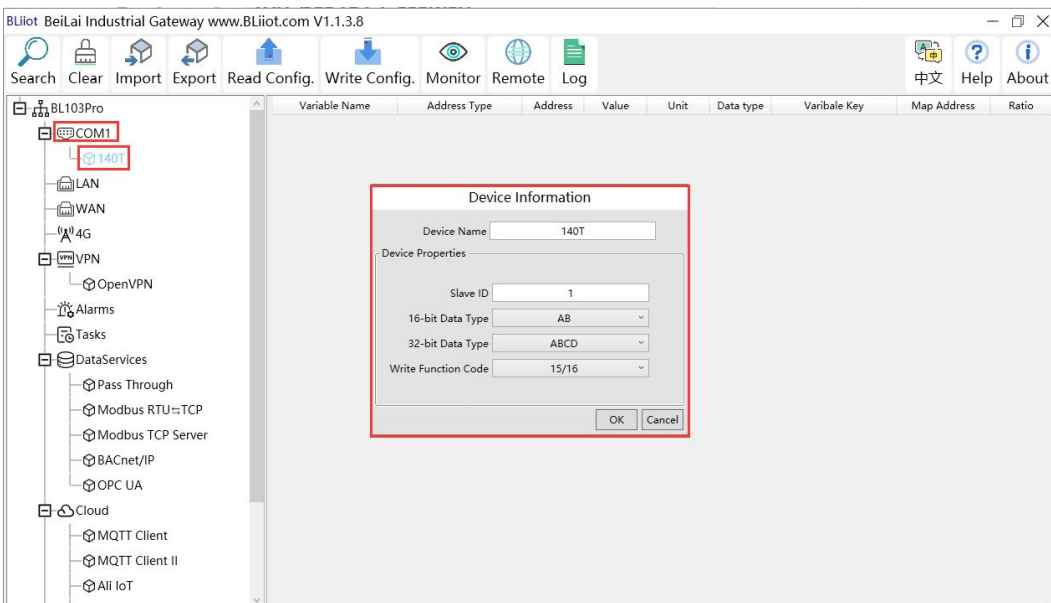

- (1) Click COM1, right click the mouse and click Add to enter configuration box
- (2) Set device name, for example, set M140T as device name
- (3) Input device modbus address, for example, if M140T Modbus ID is 1, put 1

- (4) Select Type of data to be collected. The example is to collect the DI and DO of the M140T, both of which are Boolean type, not numeric type register, select as default.
- (5) Write function code: As default, M140T supports writing multiple registers.
- (6) Click OK to confirm adding M140T
- (7) Click COM1 to view the added device M140T. If more devices to be added, perform the same procedures as above Step (1)-(6)

Note: Click Write Configuration. Gateway BL102 will restart automatically. After restarting, M140T is added successfully.

5.1.2.3 Add COM Port Device M140T Datapoint

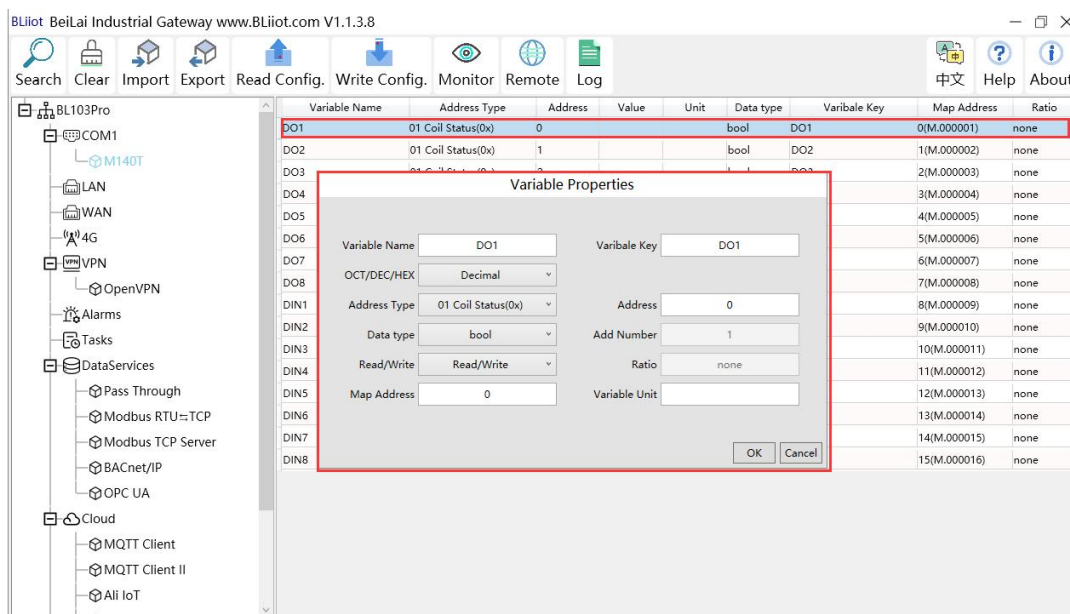

- (1) Click M140T, move mouse cursor to the right box, right click mouse to enter datapoint configuration window
- (2) Variable name: Set datapoint name, for example, DO1
- (3) Variable key, which can be filled in arbitrarily. The identifier cannot be repeated, for example, the MQTT identifier of the DO1 data point is filled in as DO1.
- (4) Select the acquisition address and choose data format according to the requirements, OCT/DEC/HEX are octal/decimal/hexadecimal respectively. The collected Modbus protocol address is input in decimal, so the example selects decimal.
- (5) Address type: Select according to the function codes supported by the collected data points. For example, the DO of the collected M140T supports the "01" function code, so select "01 Coil Status", and DI supports the "02" function code, so select "02 Input Status"
- (6) Address: the register address of the data point, such as: data point DO1 is "0" register address in the M140T, so fill in "0".
- (7) Data type: Select according to the data point, such as: DI and DO of M140T are both coil types,

so select "bool".

- (8) Add Number: If it is collecting continuous addresses, the same function code can be collected multiple times.
- (9) Read/Write: Automatic identifying read-write type according to Address Type
- (10) Map address: fill in the address where the collected data points are stored to the BL102 gateway device, which can be filled in at will. Mapped addresses cannot be duplicated. Range: 0-2000. For example, the data collected from DO1 is stored in the "0" register address of the BL102 gateway. The outside of the mapping address on the configuration software represents the Modbus address, and M.XXX represents the PLC Modbus address.
- (11) Variable Unit: Input any required unit
- (12) Click OK to confirm

Note: After clicking OK to confirm the configuration, datapoints will appear in the box like above picture. If more datapoints to be added, right click the box and click Add to enter datapoint configuration box, repeat Step (2)-(12)

Note: Click Write Configuration. Gateway will restart automatically. After restarting, M140T datapoints are added successfully

5.1.3 Ethernet Port Configuration

Both WAN and LAN can collect device data. The configuration procedure is the same.

5.1.3.1 LAN Port Configuration

Below is the example of configuring LAN port to connect S475.

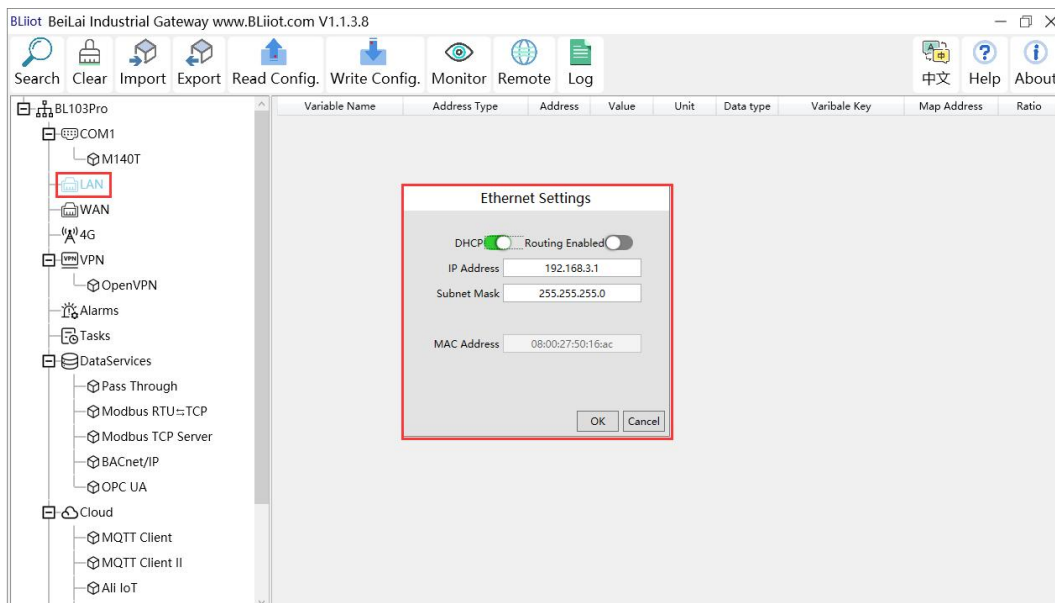

- (1) Double click LAN to enter configuration box
- (2) DHCP: enable auto IP distribution. Default is disabled. For examples, S475 has been set to auto retrieving IP, then LAN port must enable DHCP.
- (3) Routing: Enable network routing function. Default is disabled. For example, S475 data will be collected without network requirement, then disable routing function
- (4) IP Address: default is 192.168.3.1, the IP addresses assigned to LAN port devices must be within the range. It can be changed according to requirement. For example, S475 is set to auto retrieving IP and the range is not limited, thus it's not necessary to change it.
- (5) Subnet mask, the subnet mask of the LAN port gateway.
- (6) MAC Address: Input LAN port MAC address
- (7) Click OK to confirm it

Note: Click Write Configuration and Gateway will restart. Turn off the power of Gateway and restart it. After that LAN port configuration is done successfully

Note: LAN Port IP Address specifies the IP address arrange of LAN port device. If device IP address is not within the range, data can't be collected. Thus it's necessary to change LAN port IP address according to requirement. IP Address change will not be effective until gateway is powered off and powered on again.

5.1.3.2 Add LAN Port Device S475

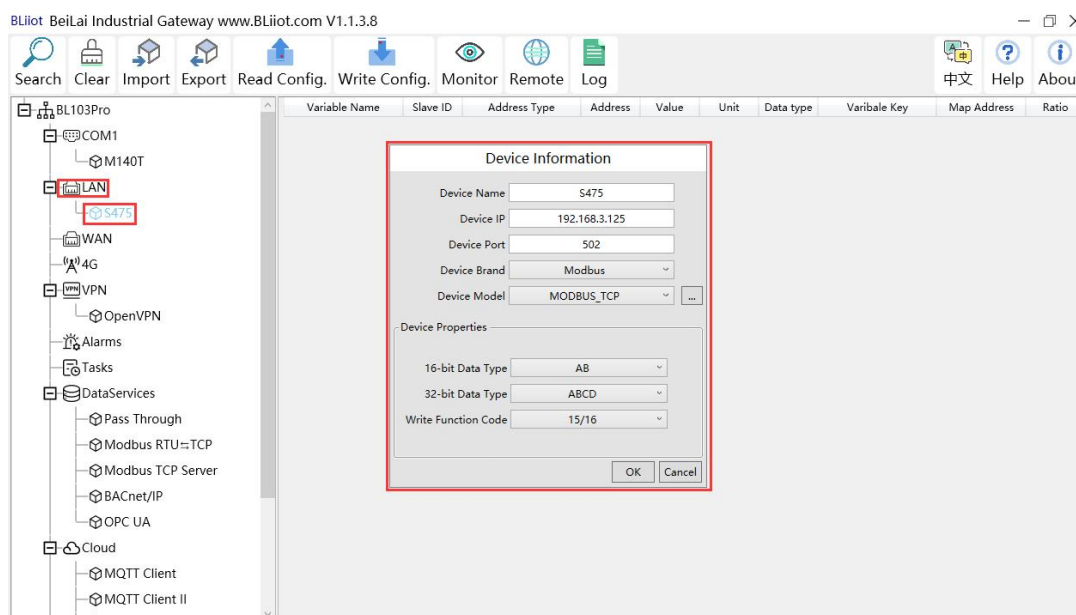

- (1) Click LAN and right click mouse to enter device configuration box
- (2) Device Name: input the name of device to be added, such as S475
- (3) Device IP: input S475 IP address. For example, S475 is set to auto retrieving IP. Open S475 configuration software and view its IP(192.168.3.125). Thus input S475 IP 192.168.3.125.

Note: if LAN port IP is changed and LAN port device auto retrieves IP, please click Write Configuration, power off gateway and power it on again. Then IP change can be viewed

- (4) Device Port: input LAN port device port. For example, S475 Modbus TCP port is 502. Thus put

502

- (5) Device Brand: Modbus; Device Model: Modbus TCP
(BL102 collects S475 through LAN port through Modbus TCP protocol)
- (6) The polling interval and timeout in the button can be defaulted and filled in according to requirements.
- (7) Select Data Type. For example, S475 power source and temperature & humidity data is 16-bit AB type, 32-bit data is not collected. Thus select 16-bit AB type and keep 32-bit data type with default setting
- (8) Write function code: choose 15/16, and choose according to the function code supported by the device.
- (9) Click OK to confirm the setting

Note: S475 device icon will appear after confirming the configuration. If more devices to be added, perform the same procedure as Step (1)-(9)

Note: Click Write Configuration and gateway will restart automatically. After restarting, device S475 is added successfully

5.1.3.3 Add LAN Port Device S475 Datapoint

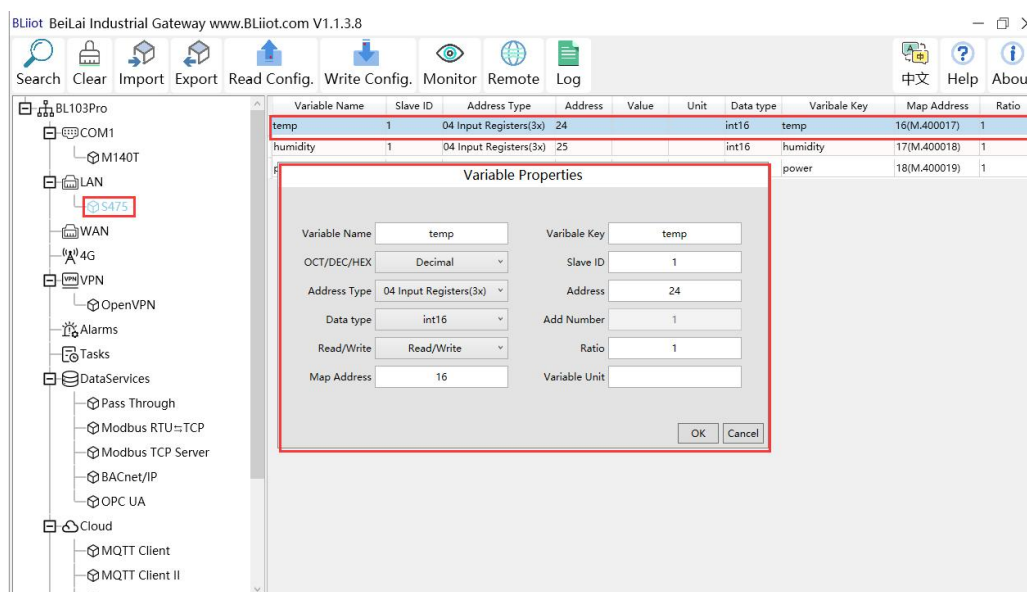

- (1) Click S475, move mouse cursor to the right box, right click the mouse and click Add to enter datapoint configuration box
- (2) Variable Name: Set the name of datapoint, for example, temp
- (3) Variable key, which can be filled in arbitrarily. The identifier cannot be repeated. For example, the MQTT identifier of the temperature data point is filled in as temp.
- (4) Select the acquisition address and choose data format according to the requirements. OCT/DEC/HEX are octal/decimal/hexadecimal respectively. The collected Modbus protocol address is input in decimal, so the example selects decimal.

- (5) Slave ID: The Modbus ID of the S475 device is "1", so fill in "1".
 - (6) Address Type: S475 temperature supports function code 04, thus select 04 input register
 - (7) Address: 24 (Datapoint temperature register address in S475 is 24)
 - (8) Data Type: S475 temperature is 16-bit signed numeric data, thus select int16
 - (9) Add Number: If consecutive addresses to be collected, the same function code can collect it simultaneously.
 - (10) Read/Write: Automatic Identifying it according to Address Type
 - (11) Ratio: Set the ratio to be multiplied or minified for uploading to cloud
 - (12) Map Address: For example, S475 temperature data is saved in register address 8 of BL102. Modbus mapping address can be any from 0 to 2000 and it can't be repeated. The outside of the mapping address on the configuration software represents the Modbus address, and M.XXX in brackets represents the PLC Modbus address.
 - (13) Variable unit: fill in according to requirements, or not fill in.
 - (14) Click OK to confirm.
- Note: After confirming the configuration, datapoints will appear in the box like above picture. To add more datapoints, right click the box and click Add to enter configuration box. Perform the same procedure as Step (2)-(14)
- Note: Click Write Configuration. Gateway will restart automatically. After device restarting, S475 datapoint is added successfully.**

5.1.4 Uploading Data to Various Clouds

BL102 collects data of different protocols. The configuration procedures of uploading data to various clouds are the same. Here only introduce configuration of collecting PLC data and send it to various clouds. Refer to [5.4 Configuration of Uploading Data to Various Clouds](#)

5.2 Collecting PLC Data

5.2.1 Configuring Collecting Siemens PLC Data

5.2.1.1 Add Siemens PLC to COM Port

S7-200 COM is RS485. Below is example of adding Siemens PLC S7-200 to COM. Connect S7-200 RS485 to DB9 signal pin 3 & 8. PIN 3 connects to RS485 A and PIN 8 connects to RS485 B

5.2.1.1.1 COM Port Configuration

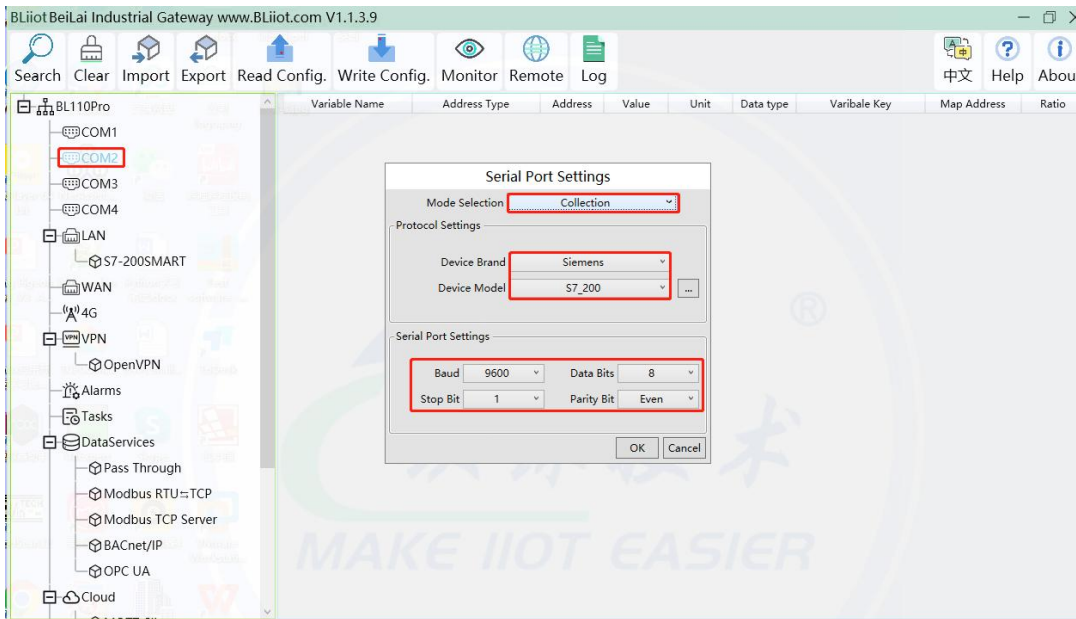

- (1) Double click COM to enter COM attribute configuration box.
- (2) Select data collection Mode
- (3) Select Siemens as Device Brand and select S7-200 as Device Model The polling interval and timeout are set according to requirements.
- (4) Follow Siemens RS485 port parameters to set the same baud rate 9600, stop bit 1, data bit 8 and parity bit Even
- (5) Click OK to confirm it.

Note: Click Write Configuration. COM port configuration will be effective after gateway restart automatically.

5.2.1.1.2 Add COM Port Device S7-200

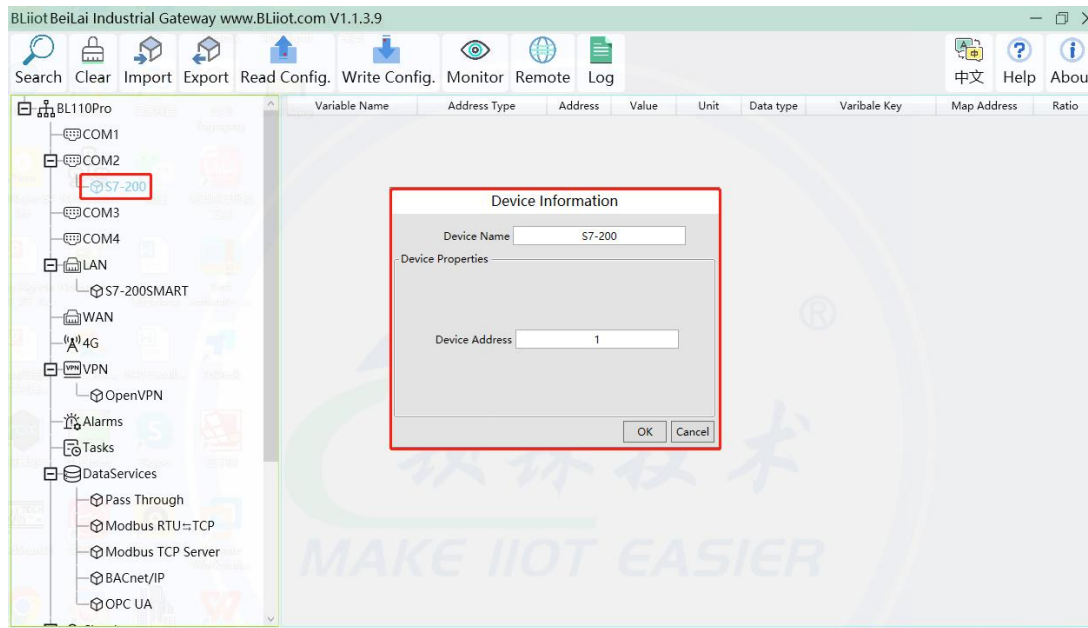

- (1) Click COM, right click it and click Add to enter device configuration box
- (2) Set Device Name at random like S7-200
- (3) Device address: S7-200 serial port address, fill in as required, the address should be consistent with the S7-200 setting, otherwise the communication will fail
- (4) Click OK to confirm adding S7-200

Note: After confirming configuration, S7-200 device icon will appear below COM. To add more devices, follow the same steps (1)-(4)

Note: Click Write Configuration. Gateway will restart automatically and adding PLC S7-200 is effective

5.2.1.1.3 Add COM Port Device S7-200 Datapoint

Below is part of S7-200 register V & VW data configuration

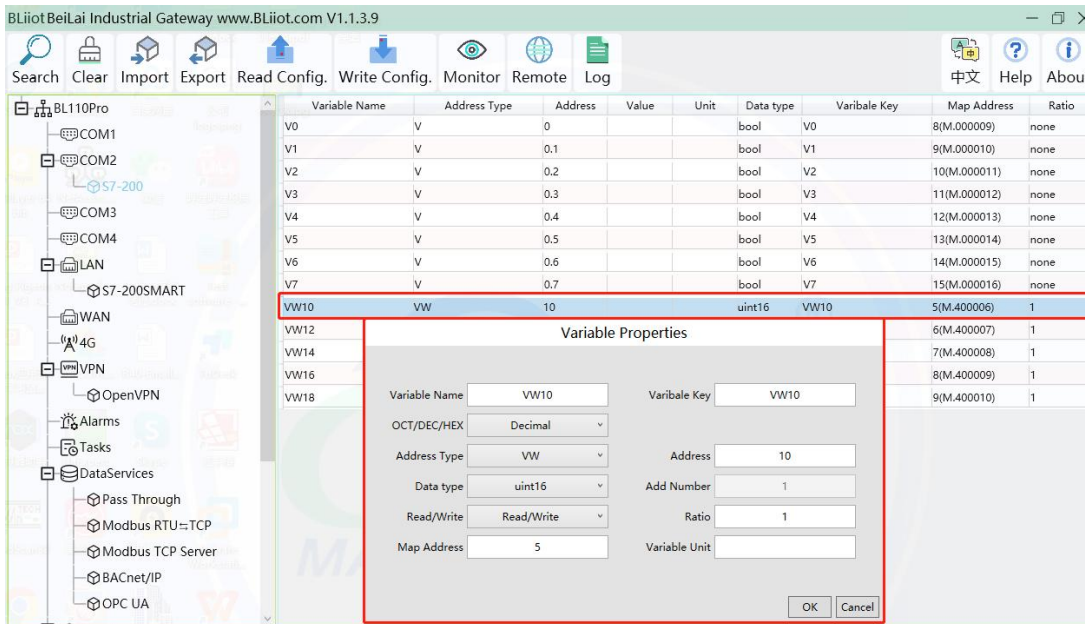

- (1) Click S7-200, move mouse cursor to the right box, right click the mouse and click Add to enter datapoint configuration box
- (2) Variable Name: Set the name of datapoint to be collected, for example, VW10
- (3) Variable key, which can be filled in arbitrarily. The identifier cannot be repeated. For example: VW10
- (4) Select the collection address according to the requirements and data format filled in the input gateway. OCT/DEC/HEX are octal/decimal/hexadecimal respectively. Siemens I and Q data points are octal, but only decimal can be used because of decimals.
- (5) Address Type: select address type according to PLC register. Here VW10 address type is VW
- (6) Address: Register address of datapoint. Here VW0 address is 10
- (7) Data Type: select data type according to PLC register type
- (8) Add Number: If addresses are consecutive, the same register will collect multiple addresses.
- (9) Read/Write: select from Read only and Read & Write.
- (10) Ratio: set the ratio to be multiplied or minified for uploading to cloud
- (11) Map Address: Set address where datapoint will be saved in BL102.

Modbus mapping address can be any from 0 to 2000 and it can't be repeated.

For example, set 18 as VW10 mapping address. The outside of the mapping address on the configuration software represents the Modbus address, and M.XXX in the brackets represents the PLC Modbus address.

- (12) Variable unit: fill in according to requirements, or not fill in.
- (13) Click OK to confirm.

Note: After confirming the configuration, datapoints will appear in the box like above picture. To add more datapoints, right click the box and click Add to enter configuration box. Perform the same procedure as Step (2)-(13)

Note: Click Write Configuration. Gateway will restart automatically and S7-200 datapoint is added successfully.

5.2.1.2 Adding Siemens PLC via Ethernet Port

Siemens PLC data can be collected through WAN, LAN and cascaded switch.

5.2.1.2.1 LAN Port Configuration

Below is example of connecting Siemens PLC S7-200SMART to BL102 LAN port. LAN port configuration is as below:

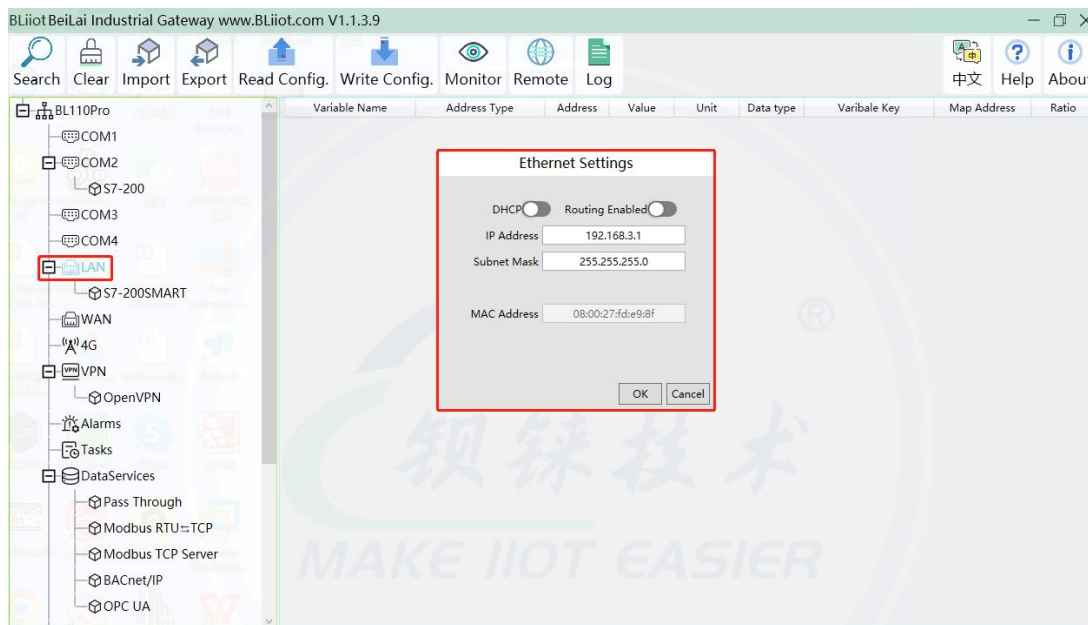

- (1) Double click LAN to enter configuration box
- (2) DHCP: enable auto IP distribution. Default is disabled.
- (3) Routing: Enable network routing function. Default is disabled. For example, PLC S7-200SMART does not need network. Thus it's necessary to enable it.
- (4) IP Address: default is 192.168.3.1, the IP addresses assigned to LAN port devices must be within the range. WAN and LAN IP address can't be the same. For example, S7-200SMART IP is fixed, then change IP address of gateway.
- (5) Subnet mask: Subnet mask of the LAN port gateway.
- (6) MAC Address: Input LAN port MAC address
- (7) Click OK to confirm it

Note: Click Write Configuration and Gateway will restart. Turn off the power of Gateway and restart it. After that LAN port configuration is done successfully

Note: LAN Port IP Address specifies the IP address arrange of LAN port device. If device IP address is not within the range, data can't be collected. Thus it's necessary to change LAN port IP address according to requirement. IP Address change will not be effective until gateway is power off and powered on again

5.2.1.2.2 Add LAN Port Siemens PLC S7-200SMART

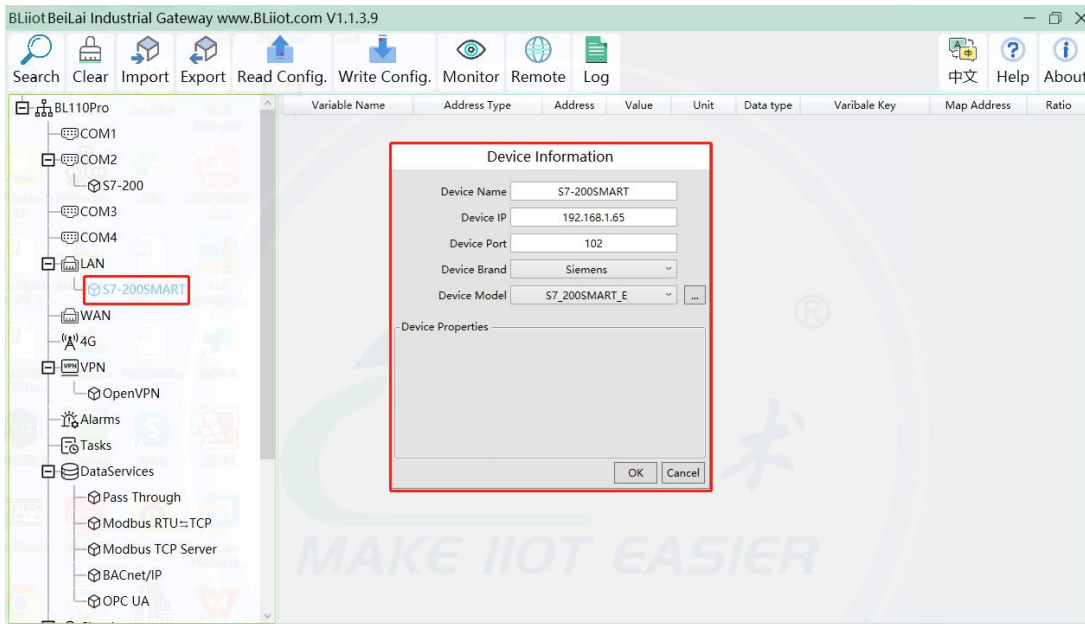

- (1) Click LAN and right click mouse and click Add to enter device configuration box
- (2) Device Name: set device name, for example, set S7-200SMART as device name.
- (3) Device IP: input PLC IP address. For example, PLC S7-200SMART IP is 192.168.3.16, thus put 192.168.3.16 here. **This is PLC IP address. PLC IP address and LAN Port IP address must be in the same range.**
- (4) Device Port: input LAN port device port. Default port of S7-200SMART is 102. Thus put 102.
- (5) Device Brand: Select Siemens as Device Brand and select S7-200SMART as device model The polling interval and timeout are set according to requirements.
- (6) Click OK to confirm adding PLC S7-200SMART

Note: S7-200SMART device icon will appear after confirming the configuration. If more devices to be added, perform the same procedure as Step (1)-(6)

Note: Click Write Configuration and gateway will restart automatically. After restarting, PLC S7-200SMART is added successfully

5.2.1.2.3 Add LAN Port Siemens PLC S7-200SMART Datapoint

Below is part of S7-200SMART register Q & VW data configuration

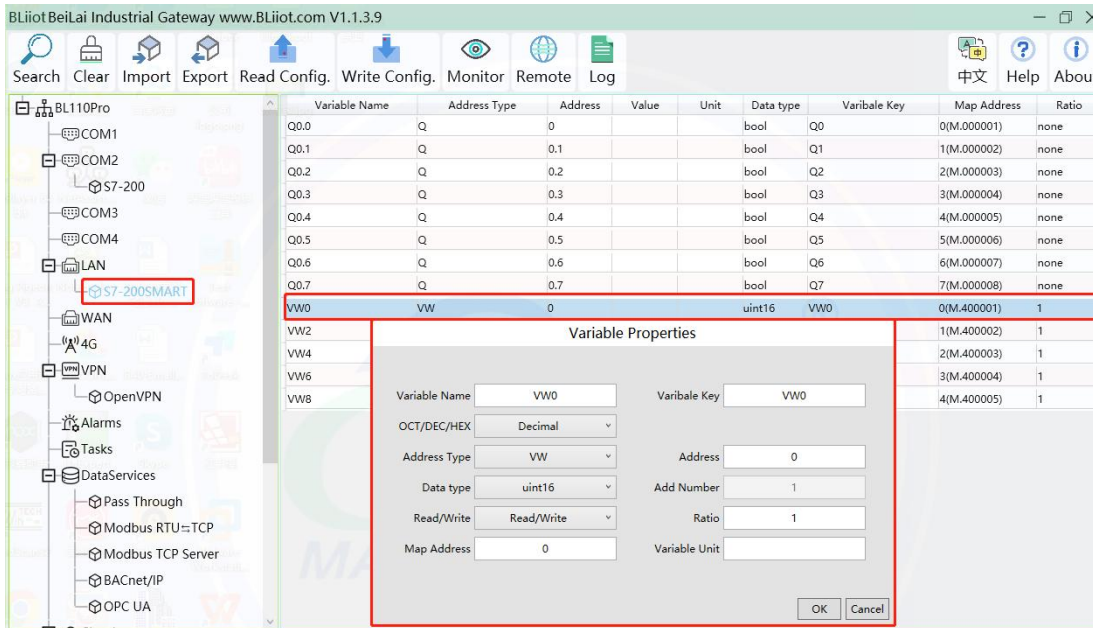

- (1) Click S7-200SMART, move mouse cursor to the right box, right click the mouse and click Add to enter datapoint configuration box
- (2) Variable Name: Set the name of datapoint, for example, VW0
- (3) Variable key, which can be filled in arbitrarily. The identifier cannot be repeated. For example: VW0
- (4) Select the collection address according to the requirements and data format filled in the input gateway. OCT/DEC/HEX are octal/decimal/hexadecimal respectively. Siemens I and Q data points are octal, but only decimal can be used because of decimals.
- (5) Address Type: select address type according to PLC register. Here VW0 address type is VW
- (6) Address: Register address of datapoint. Here VW0 address is 0
- (7) Data Type: select data type according to PLC register type
- (8) Add Number: If addresses are consecutive, the same register will collect multiple addresses.
- (9) Read/Write: select from Read only and Read & Write.
- (10) Ratio: Set the ratio to be multiplied or minified for uploading to cloud
- (11) Map Address: Set address where datapoint will be saved in BL102.

Modbus mapping address can be any from 0 to 2000 and it can't be repeated

For example, set 8 as VW0 mapping address. The outside of the mapping address on the configuration software represents the Modbus address, and M.XXX in the brackets represents the PLC Modbus address.

- (12) Variable unit: fill in according to requirements, or not fill in.
- (13) Click OK to confirm.

Note: After confirming the configuration, datapoints will appear in the box like above picture. To add more datapoints, right click the box and click Add to enter configuration box. Perform the same procedure as Step (2)-(13)

Note: Click Write Configuration. Gateway will restart automatically and S7-200SMART datapoint is added successfully.

5.2.1.3 Uploading Data to Various Clouds

BL102 collects data of different protocols. The configuration procedures of uploading data to various clouds are the same. Here only introduce configuration of collecting PLC data and send it to various clouds. Refer to [5.4 Configuration of Uploading Data to Various Clouds](#)

5.2.2 Configuring Collecting Mitsubishi PLC Data

5.2.2.1 Add Mitsubishi PLC to COM Port

FX3U has RS422 port. Connects Mitsubishi PLC FX3U with RS422 to RS232 converting cable to COM1. Configure it as below procedure.

5.2.2.1.1 COM1 Configuration

Connect FX3U with RS422 to RS232 converting cable to COM1. Configure it as below

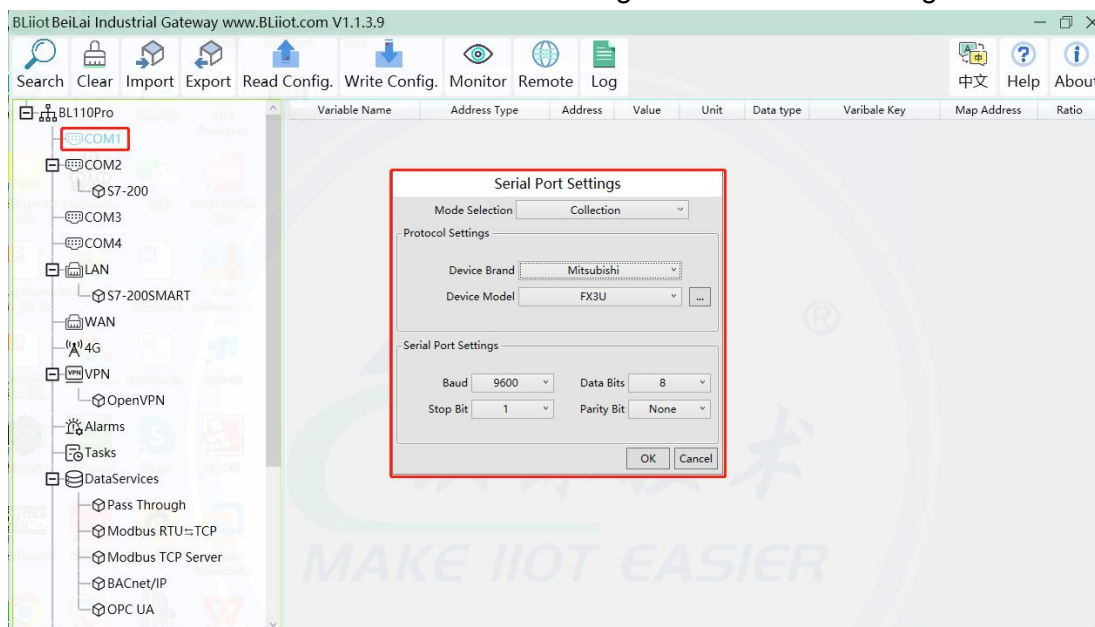

- (1) Double click COM1 to enter COM attribute configuration box.
- (2) Select data collection Mode: Collection
- (3) Select Mitsubishi as Device Brand and select FX3U as Device Model The polling interval and timeout are set according to requirements.
- (4) Follow PLC FX3U RS422 port parameters to set the same baud rate 9600, stop bit 1, data bit 7

and parity bit Even

(5) Click OK to confirm it.

Note: Click Write Configuration. COM port configuration will be effective after gateway restart automatically.

5.2.2.1.2 Add Mitsubishi PLC FX3U to COM Port

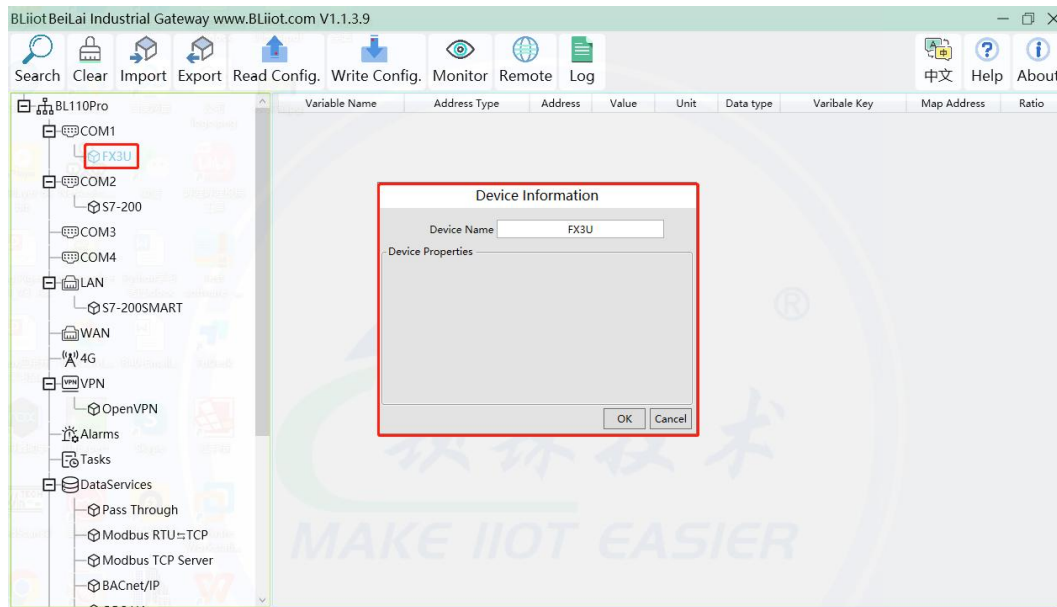

(1) Click COM1, right click it and click Add to enter device configuration box

(2) Set Device Name at random like FX3U

(3) Click OK to confirm adding FX3U PLC.

Note: After confirming configuration, FX3U device icon will appear below COM1. To add more devices, follow the same steps (1)-(3)

Note: Click Write Configuration. Gateway will restart automatically and adding PLC FX3U is effective

5.2.2.1.3 Add COM Port Mitsubishi PLC FX3U Datapoint

Below is example of collecting PLC FX3U datapoints Y0-Y7 & D0-7

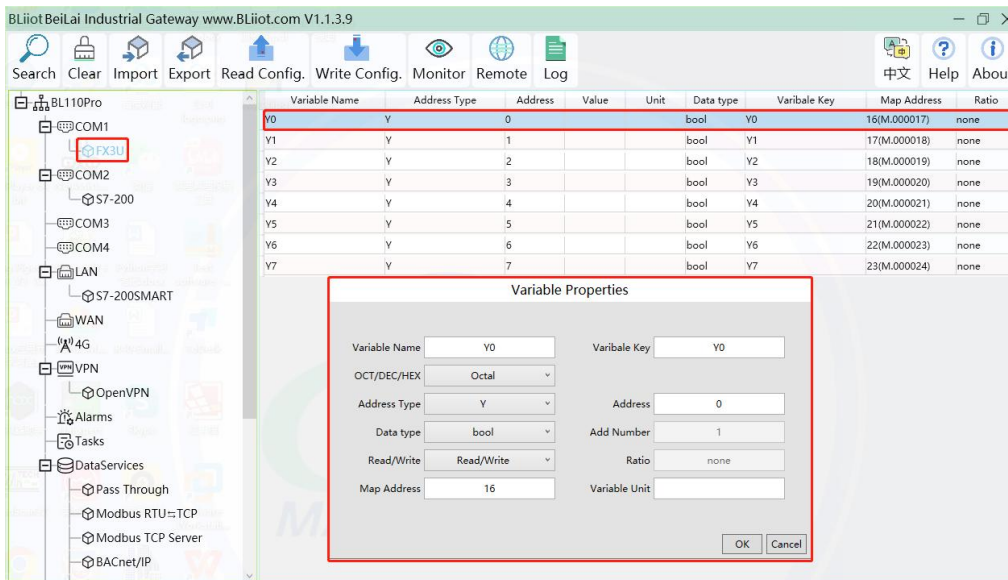

- (1) Click FX3U, move mouse cursor to the right box, right click mouse and click Add to enter datapoint configuration window
- (2) Variable Name: Set datapoint name, for example, Y0
- (3) Variable key, which can be filled in arbitrarily. The identifier cannot be repeated. For example: Y0
- (4) Select the collection address according to the requirements and data format filled in the input gateway. OCT/DEC/HEX are octal/decimal/hexadecimal respectively. The X and Y data points of FX3U are octal, so choose octal
- (5) Address Type: Select the address type of Mitsubishi PLC register. Select Y for collecting Y0 datapoint
- (6) Address: Input datapoint register address, for example, Y0 register address in FX3U is 0, input 0
- (7) Data Type: Select data type according to PLC register. For example, select bool for Y as it's coil type.
- (8) Add Number: If consecutive addresses are collected, the same register can collect multiple addresses.
- (9) Read/Write: Select from Read only and Read & Write according to PLC register.
- (10) Map Address: Input the address where the collected datapoint is saved in BL102. It can be any address from 0-2000 but can't be repeated. For example, Y0 data is saved in register address 0 of BL102. The outside of the mapping address on the configuration software represents the Modbus address, and M.XXX in the brackets represents the PLC Modbus address.
- (11) Variable unit: fill in according to requirements, or not fill in.
- (12) Click OK to confirm

Note: After clicking OK to confirm the configuration, datapoints will appear in the box like above picture. If more datapoints to be added, right click the box and click Add to enter datapoint configuration box, repeat Step (2)-(12)

Note: Click Write Configuration. Gateway will restart automatically. After restarting, PLC FX3U datapoints are added successfully

5.2.2.2 Adding Mitsubishi PLC to Ethernet Port

Supports acquisition of Mitsubishi Q series (Q03UDE, Q04UDEH, Q06UDEH, Q10UDEH, Q13UDEH, Q20UDEH, Q26UDEH, Q002UD), L series (L02, L26-BT), FX5U series.

Both the WAN port and the LAN port can collect the Mitsubishi PLC, which can be directly connected to the Mitsubishi PLC or collected through the switch. The configuration principle of the WAN port and the LAN port is the same. WAN port or LAN port acquisition configuration parameters of Mitsubishi Q/L series or FX5U should be consistent with the settings on the PLC.

For example, the parameter setting on Q06UDEH of Q series, Q/L series should select MC protocol communication.

5.2.2.2.1 WAN Port Configuration

WAN port collect data from FX5U through the switch, and the switch is connected to the external network.

The configuration of the WAN port is as follows:

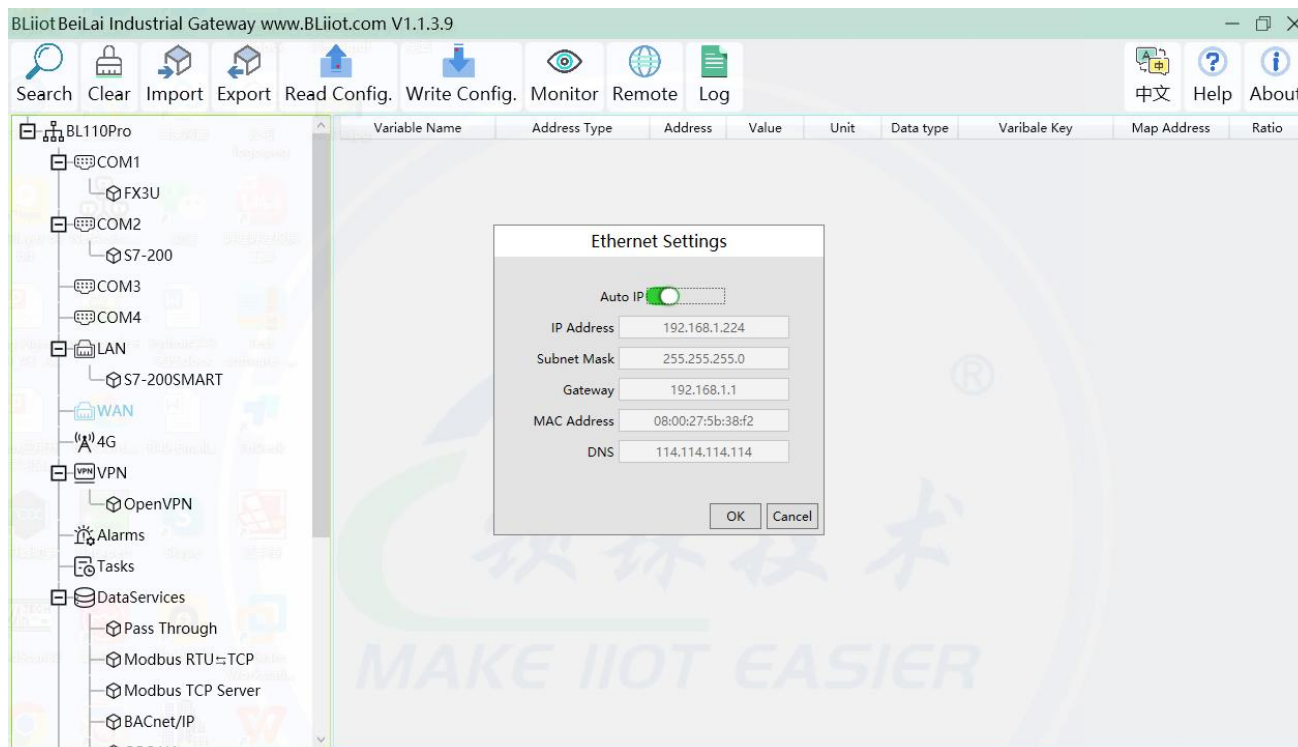

(1) Double-click "WAN" to pop up the WAN port configuration box.

(2) Auto IP: Whether the WAN port is enabled to obtain IP automatically, it is enabled by default, and can be set as required. In this example, the switch is connected to a router, and the router is enabled to automatically assign IP, so keep it enabled.

(3) IP address: The gateway obtains the IP address from the router. If it is a designated IP, set it according to the requirements, the PLC and the gateway should be in the same local area network.

(4) Subnet mask, the subnet mask of the WAN port gateway, if it is a designated IP, set it according to the requirements.

(5) Gateway: The gateway address obtained from the router. If you specify an IP, set it according to your

needs.

(6) MAC address: the MAC address of the gateway.

(7) DNS: The DNS obtained by the gateway from the route, if it is a specified IP, set it according to the requirements.

(7) Click "OK".

Note: Click "Write Configuration" to restart the gateway automatically, and the configuration of the WAN port will not be changed until the restart.

Note: The IP address of the WAN port is the IP address that specifies which network segment the WAN port device is. If the IP address of the WAN port device is not the IP of the network segment set by the WAN, the WAN port cannot be collected. It is necessary to change the WAN port IP or change the WAN port according to the needs. The IP address of the port device. After changing the IP address of the gateway, it must be written into the configuration, and it will take effect after power off and restart.

5.2.2.2.2 Add Mitsubishi FX5U to WAN Port

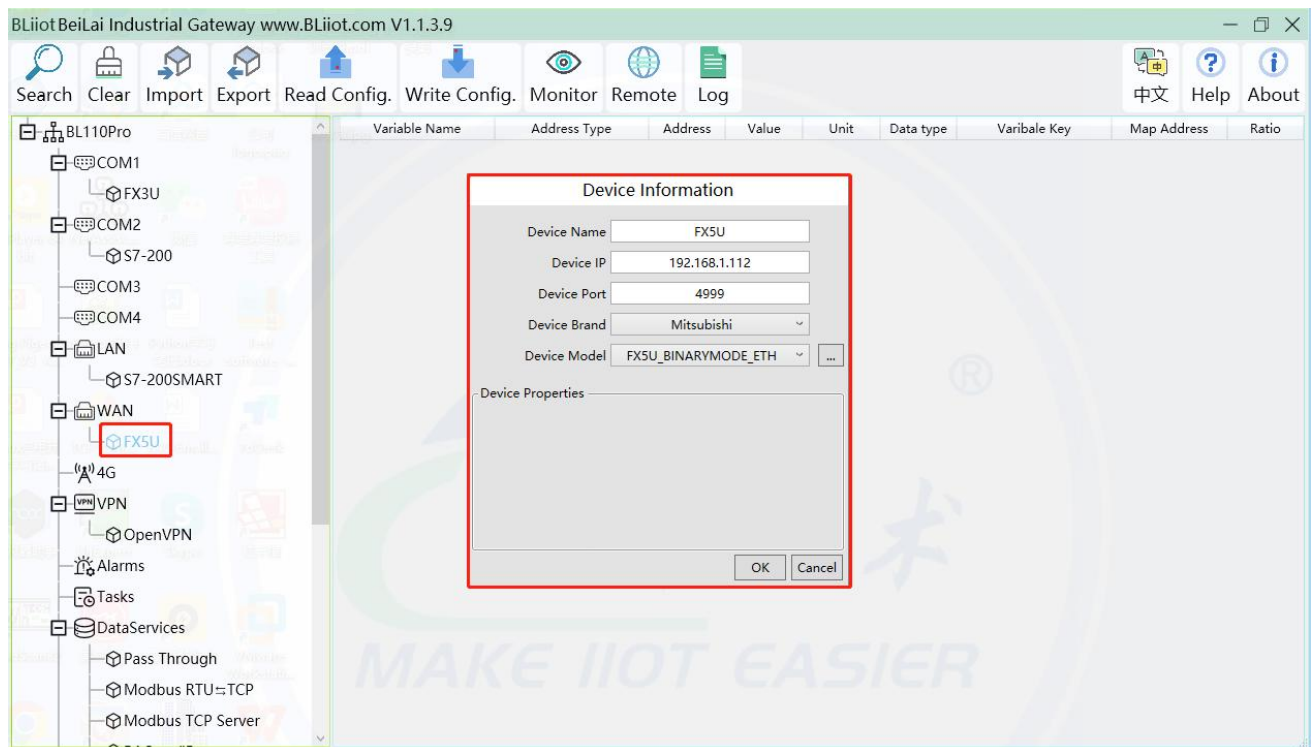

Click "WAN", click the right mouse button, click "Add" to enter device configuration box.

(2) Device name: Name the device, for example, because Mitsubishi FX5U is an example, you can fill in FX5U.

(3) Fill in the IP of the acquisition device, because the designated IP of FX5U is changed to: 192.168.1.112, so fill in 192.168.1.112 here. The IP is viewed on the Mitsubishi programming software. Fill in the IP of the PLC here. It should be noted that the IP of the PLC should be in the same network segment as the IP of the WAN port.

(4) Device port : Fill in as required. The example is 4999 from the Mitsubishi programming software, so it is 4999.

(5) Because it is collecting Mitsubishi FX5U, therefore, equipment brand: select Mitsubishi, equipment model: according to the communication data code setting on the Mitsubishi programming software is binary or ASCII code communication, binary select FX5U_BINARYMODE_ETH, ASCII code select FX5U_ASCII MODE_ETH. The polling interval and communication timeout can be defaulted and filled in as required.

(6) Click "OK" to add FX5U.

Note: After clicking OK, the added device will be displayed under the WAN port, as shown in the figure above. If you want to add multiple devices, repeat steps (1)-(6).

Note: Click "Write Configuration" and the gateway will restart automatically. After restarting, the FX5U added to the WAN port will be added successfully.

5.2.2.2.3 Add Mitsubishi FX5U Data Point

Configuration of data collected in register Y of FX5U is as follows:

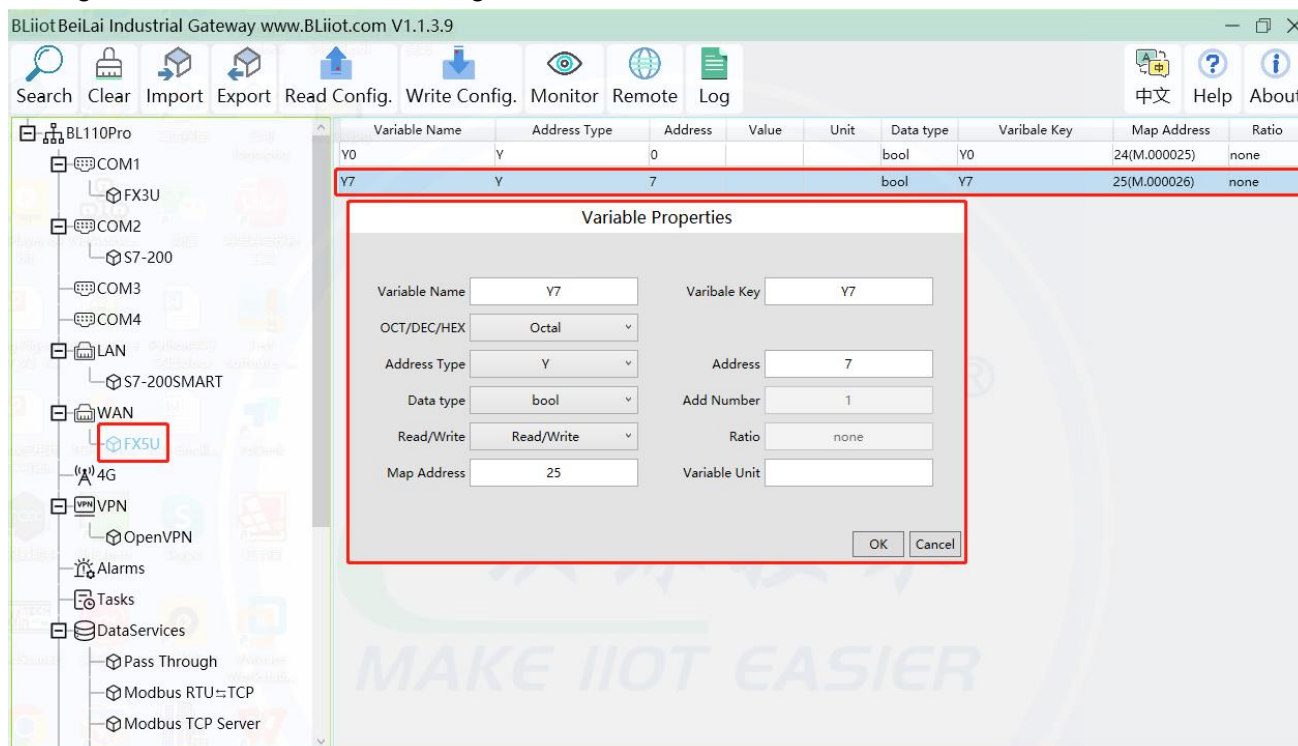

(1) Click "FX5U", move the mouse cursor to the box, right-click the mouse, and click "Add" to enter data point setting box.

(2) Variable name: Name the data point, collecting the data of "Y7", you can fill in: "Y7".

(3) The identifier of the data point can be filled in arbitrarily. The identifier cannot be repeated, for example, the identifier of the collected "Y7" data point is filled in as "Y7".

(4) Select the acquisition address fill in the input gateway in what data format according to the requirements. OCT/DEC/HEX are octal/decimal/hexadecimal respectively. Mitsubishi FX5U X and Y data points are octal, so choose octal. Select according to the needs, such as register W is hexadecimal, register D is decimal.

(5) Address type: Selected according to the collected PLC data points. Collect the data of "Y7", select

"Y".

(6) Address: the register address of the collected data point, Collecting the data of "Y7", the address is: 7.

(7) Data type: According to the type of register selected by PLC.

(8) Add Number: If it is to collect continuous addresses, the same register can be collected multiple times.

(9) Read/Write: choose from "read only", "read and write".

(10) Ratio: Set the ratio to be multiplied or minified for uploading to cloud

(11) Map address: Set address where datapoint will be saved in BL102. Modbus mapping address can be any from 0 to 2000 and it can't be repeated. The mapping address is "17" for collecting "Y7". The outside of the mapping address on the configuration software represents the Modbus address, and M.XXX in the brackets represents the PLC Modbus address.

(12) Variable unit: fill in arbitrarily according to requirements, or not fill in.

(13) Click "OK".

Note: After clicking "OK", the data points will be displayed in the box as shown in the figure above. If you want to continue adding data points, right-click on the box and click "Add" to enter data point configuration box, repeat (1)--(13) Steps.

Note: Clicking "Write Configuration" will restart the gateway automatically, and the data points collected from FX5U will take effect only after restarting.

5.2.2.3 Uploading Data to Various Clouds

BL102 collects data of different protocols. The configuration procedures of uploading data to various clouds are the same. Here only introduce configuration of collecting PLC data and send it to various clouds. Refer to [5.4 Configuration of Uploading Data to Various Clouds](#).

5.2.3 Collecting OMRON PLC Data

5.2.3.1 Add OMRON PLC to COM Port

Select the COM port according to the serial port board, because the gateway device 485 interface is 2-wire, if the serial port board is 485, pay attention to the serial port board DIP switch to select 2-wire or 4-wire.

5.2.3.1.1 COM Port Configuration

Takes the serial port board CP1W-CIF11 and Omron CP1L-L as examples, the serial port board DIP switches 2 and 3 are ON, the DIP switch SW4 of CP1L-L is OFF, the serial port board and other DIP switches of the

PLC The location is set as required. The serial port board RDA- or SDA- is connected to the gateway COM B, and RDB+or SDB+the gateway COM A. CP1L-L serial port configuration mode should select Host Link. COM Configuration as shown

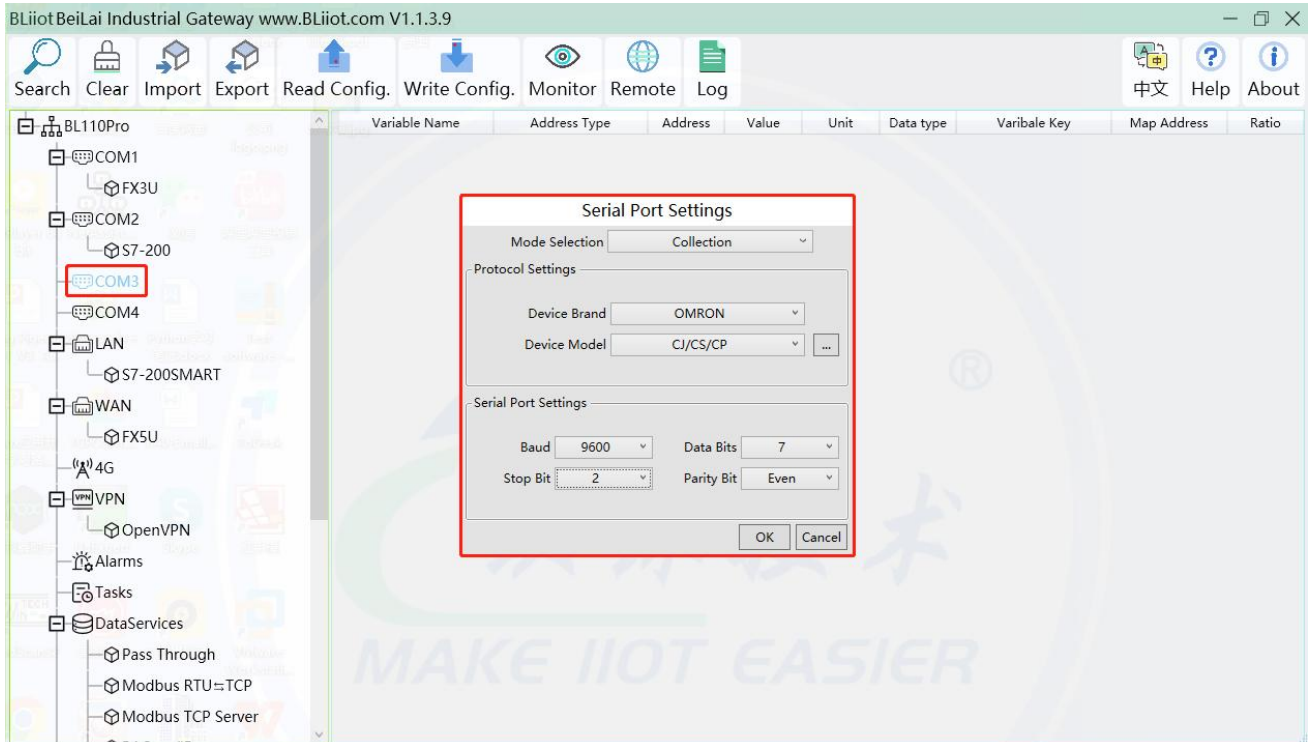

- (1) Double-click "COM" to enter COM configuration box.
- (2) Mode selection: Collection.
- (3) Since the example collection is Omron CP1L-L, the equipment brand: select "OMRON" from the drop-down box, and the equipment model: CJ/CS/CP. The polling interval and communication timeout are set according to requirements.
- (4) The baud rate, stop bit, data bit, and parity bit are configured according to the parameters of the Omron CP1L-L serial port, which are consistent with them. Viewed from the Omron programming software, the Omron serial port selects the standard baud rate: 9600, stop bit: 2, data bit: 7, parity bit: Even.
- (5) Click "OK".

Note: Click "Write Configuration" and the gateway device will restart automatically, and the configuration of the COM port will take effect after restarting.

5.2.3.1.2 Add CP1L to COM Port

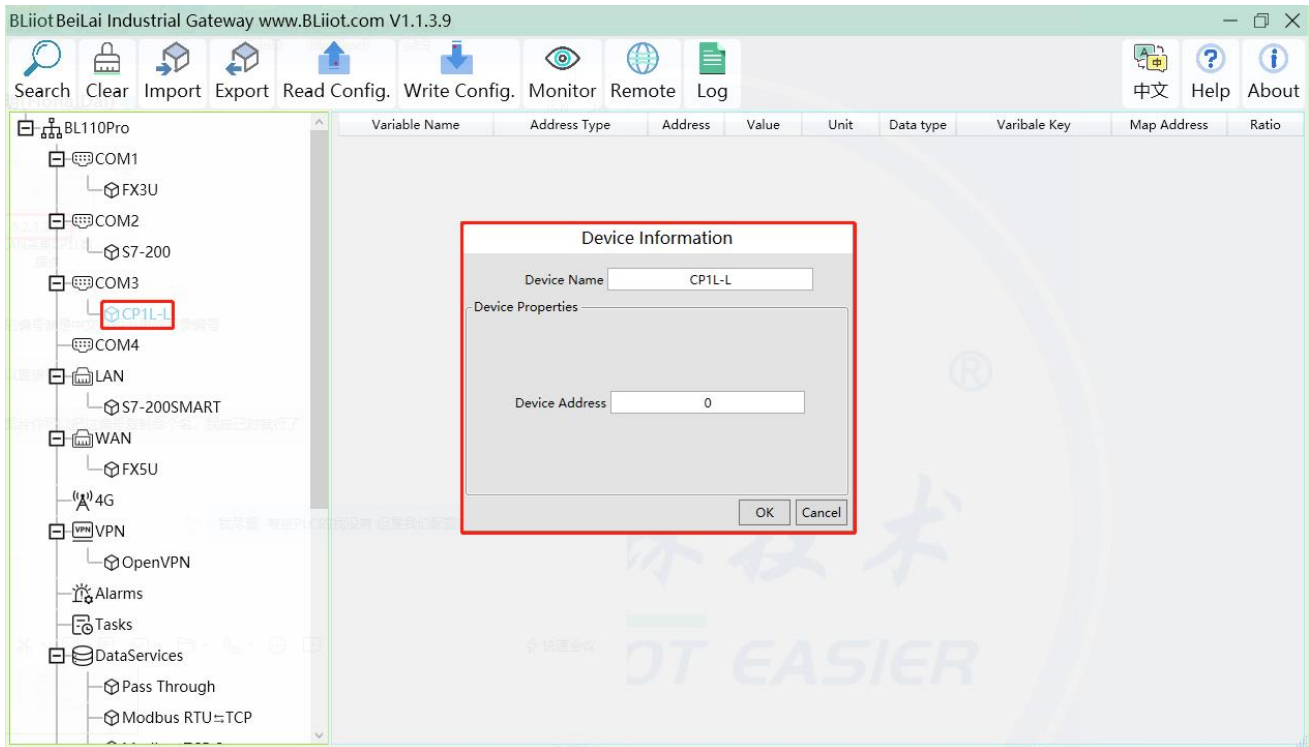

- (1) Click "COM", click the right mouse button, click "Add" to enter device configuration box.
- (2) Fill in the device name arbitrarily, such as: CP1L-L.
- (3) Device address: CP1L-L serial port unit number, fill in as required, the address must be consistent with the unit number set by CP1L-L, otherwise communication will fail.
- (4) Click "OK" to add the CP1L-L device.

Note: After clicking OK, the added devices will be displayed under COM, as shown in the figure above, CP1L-L. If you want to add multiple devices, repeat steps (1)-(4).

Note: Click "Write Configuration" to restart the gateway device automatically. After restarting, the CP1L-L device with COM port is added successfully.

5.2.3.1.3 Add CP1L Data Point

Take the CIO register of CP1L as an example

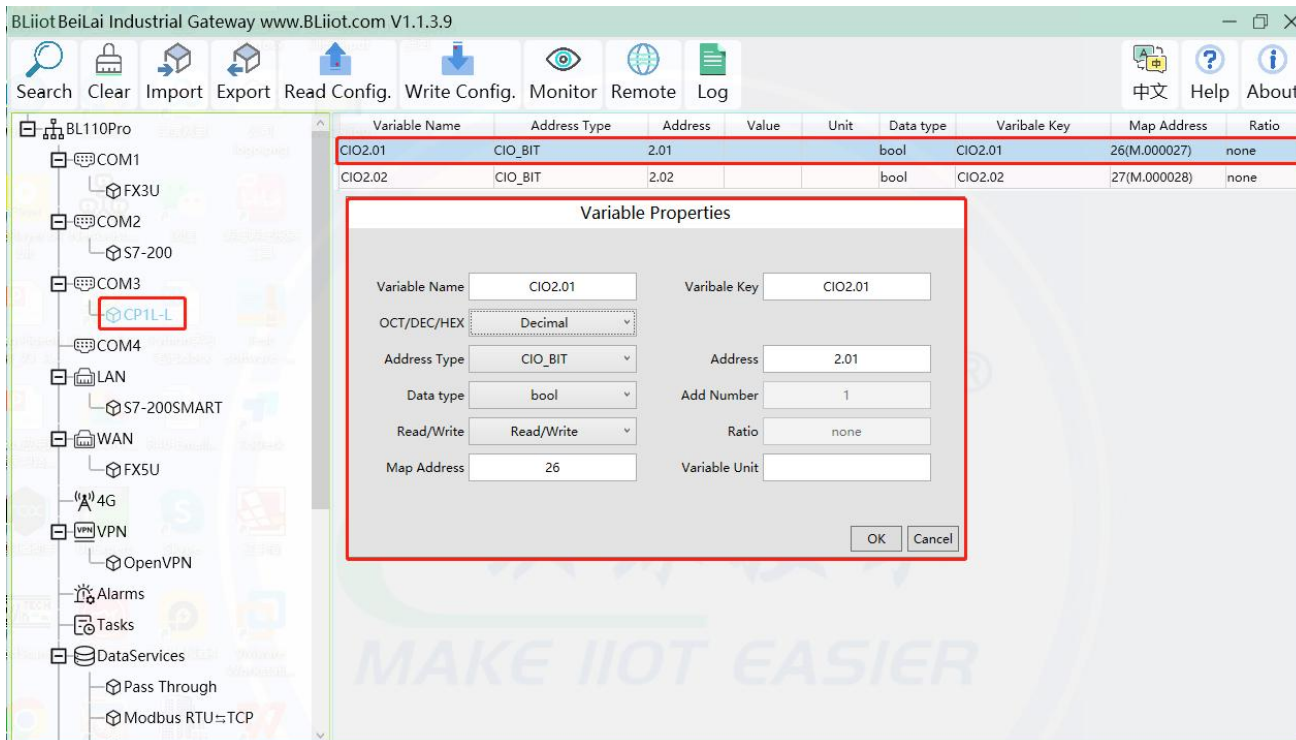

- (1) Click "CP1L-L", move the mouse cursor to the box, right-click the mouse, and click "Add" to enter data point setting box.
- (2) Variable name: Name the data point, such as: CIO2.01.
- (3) The identifier of the data point can be filled in arbitrarily. The identifier cannot be repeated. For example, the identifier of the CIO2.01 data point is filled in as CIO201. Some platform identifiers cannot recognize the decimal point.
- (4) Select the acquisition address fill in the input gateway in what data format according to the requirements. OCT/DEC/HEX are octal/decimal/hexadecimal respectively. The CIO register is collected in bits with decimals, so the decimal system is selected.
- (5) Address type: Select according to Omron's register, if you want to collect "CIO2.01", select "CIO_BIT".
- (6) Address: The register address of the collected data point, collecting "CIO2.01", so fill in "2.01".
- (7) Data type: Select according to the acquisition PLC register, such as: "CIO_BIT" is the coil type, so select "bool".
- (8) Add Number: The number of acquisitions. If it is to acquire continuous addresses, the same register can be acquired multiple times.
- (9) Read/Write: according to PLC register selection. Select from "Read Only", "Read and Write".
- (10) Map address: Fill in the address where the collected data points are stored to the BL102 gateway device, which can be filled in at will. Mapped addresses cannot be duplicated. Range: 0-2000. Such as: collect the data of CIO2.01 and store it to the "16" register address of the BL102 gateway. The outside of the mapping address on the configuration software represents the Modbus address, and M.XXX in the brackets represents the PLC Modbus address.
- (11) Variable unit: fill in arbitrarily according to requirements, or not fill in.
- (12) Click "OK".

Note: After clicking "OK", the data points will be displayed in the box as shown in the figure above. If you

want to continue adding data points, right-click on the box and click "Add" to enter data point configuration box, repeat (2)--(12) Steps.

Note: Clicking "Write Configuration" will restart the gateway automatically, and the data points added by CP1L-L will take effect only after restarting.

5.2.3.2 Add OMRON PLC via Ethernet Port

OMRON PLC data can be collected through WAN, LAN and cascaded switch

5.2.3.2.1 LAN Port Configuration

Below is example of adding OMRON PLC CP1L-EL to LAN port. Configure it as below

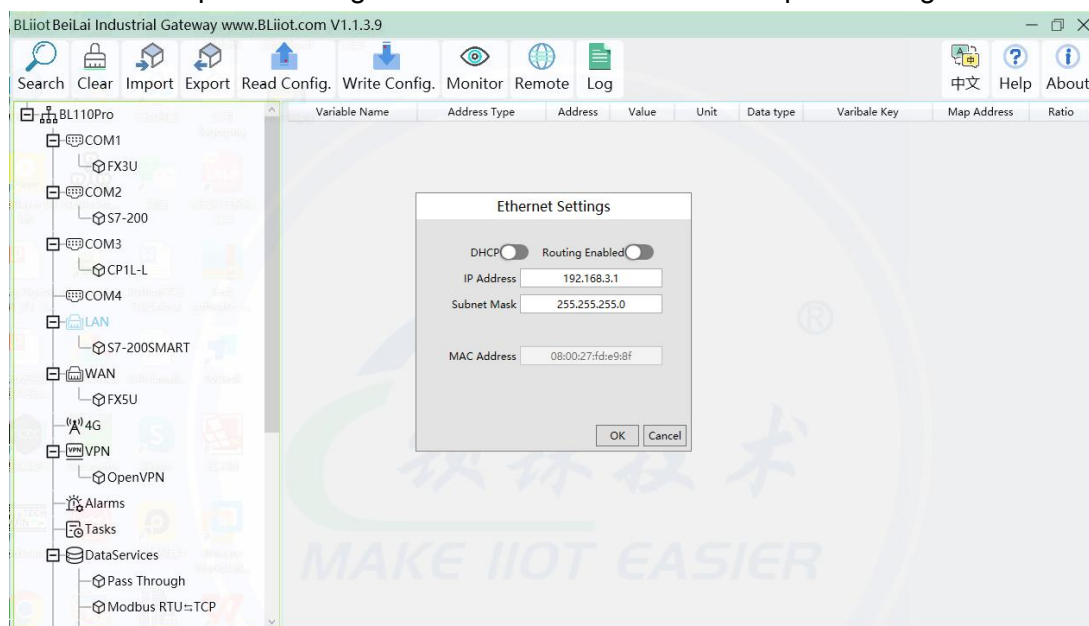

- (1) Double click LAN to enter configuration box
- (2) DHCP: Enable auto IP distribution. Default is disabled.
- (3) Routing: Enable network routing function. Default is disabled. For example, PLC CP1L-EL does not need network. Thus it's necessary to enable it.
- (4) IP Address: Default is 192.168.3.1, the IP addresses assigned to LAN port devices must be within the range. WAN and LAN IP address can't be the same. For example, CP1L-EL IP is fixed, then change IP address of gateway.
- (5) Subnet mask: Subnet mask of the LAN port gateway.
- (6) MAC Address: Input LAN port MAC address
- (7) Click OK to confirm it

Note: Click Write Configuration and Gateway will restart. Turn off the power of Gateway and restart it. After that LAN port configuration is done successfully

Note: LAN Port IP Address specifies the IP address arrange of LAN port device. If device IP address is not within the range, data can't be collected. Thus it's necessary to change LAN port IP address

according to requirement. IP Address change will not be effective until gateway is powered off and powered on again

5.2.3.2.2 Add OMRON PLC CP1L-EL to LAN Port

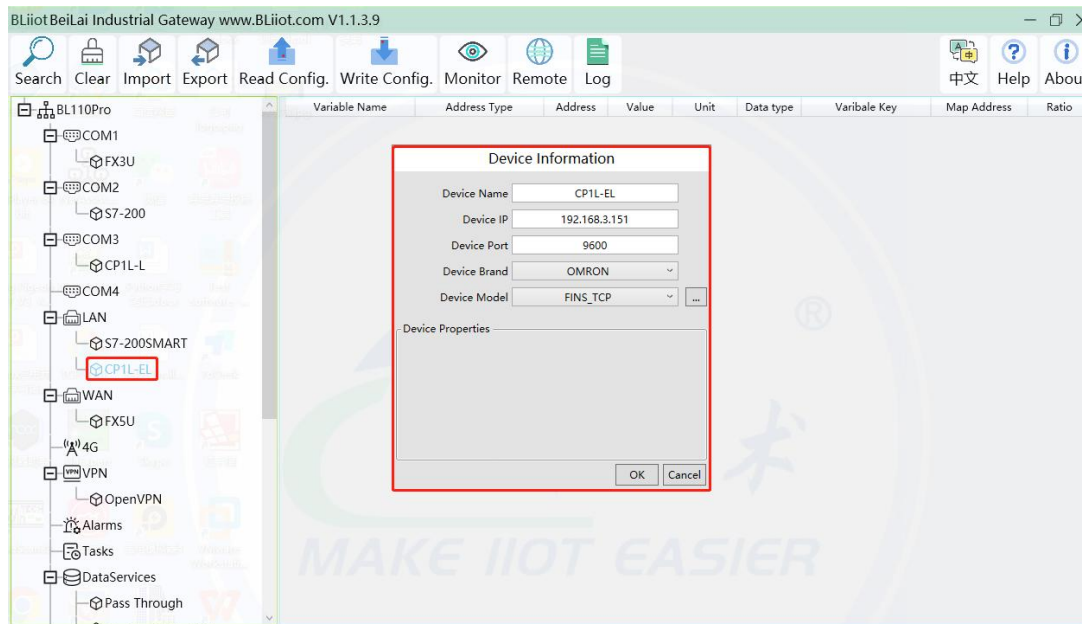

- (1) Click LAN and right click mouse and click Add to enter device configuration box
- (2) Device Name: set device name, for example, set CP1L-EL as device name.
- (3) Device IP: input PLC IP address. For example, PLC CP1L-EL IP is 192.168.3.151, thus put 192.168.3.151 here. **This is PLC IP address. PLC IP address and LAN Port IP address must be in the same range.**
- (4) Device Port: Fill in LAN port device port. CP1L-EL default port is 9600
- (5) Device Brand: Select Omron as Device Brand and select FINS_TCP as device model The polling interval and timeout are set according to requirements.
- (6) Click OK to confirm adding PLC CP1L-EL

Note: CP1L-EL device icon will appear after confirming the configuration. If more devices to be added, perform the same procedure as Step (1)-(6)

Note: Click Write Configuration and gateway will restart automatically. After restarting, PLC CP1L-EL is added successfully

5.2.3.2.3 Add LAN Port OMRON PLC CP1L-EL Datapoint

Below example is part of PLC CP1L-EL register CIO & D data configuration

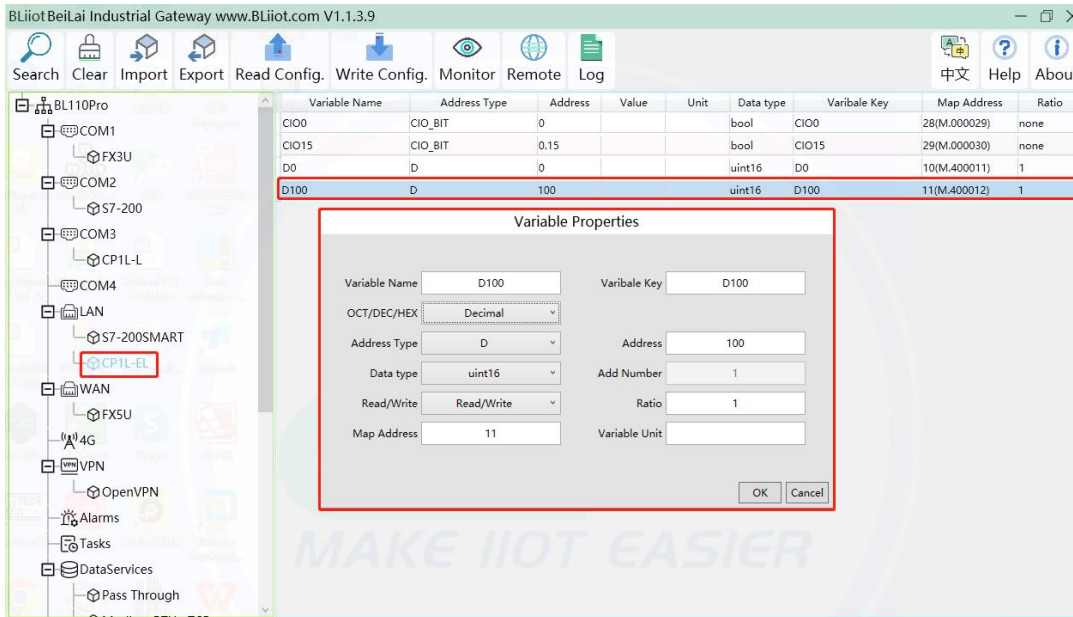

- (1) Click CP1L-EL, move mouse cursor to the right box, right click the mouse and click Add to enter datapoint configuration box
- (2) Variable Name: Set the name of datapoint, for example, D100
- (3) Variable key, which can be filled in arbitrarily. The identifier cannot be repeated. For example: D100
- (4) Select the collection address data format filled in the input gateway according to the requirements. OCT/DEC/HEX are octal/decimal/hexadecimal respectively. CP1L-EL D register is decimal, so choose decimal
- (5) Address Type: select address type according to PLC register. Here D100 address type is D
- (6) Address: Register address of datapoint. Here D100 address is 100
- (7) Data Type: select data type according to PLC register type
- (8) Add Number: If addresses are consecutive, the same register will collect multiple addresses.
- (9) Read/Write: Select from Read only and Read & Write.
- (10) Ratio: Set the ratio to be multiplied or minified for uploading to cloud
- (11) Map Address: Set address where datapoint will be saved in BL102.
Modbus mapping address can be any from 0 to 2000 and it can't be repeated
For example, set 9 as D100 mapping address. The outside of the mapping address on the configuration software represents the Modbus address, and M.XXX in the brackets represents the PLC Modbus address.
- (12) Variable unit: Fill in according to requirements, or not fill in.
- (13) Click OK to confirm.

Note: After confirming the configuration, datapoints will appear in the box like above picture. To add more datapoints, right click the box and click Add to enter configuration box. Perform the same procedure as Step (1)-(13)

Note: Click Write Configuration. Gateway will restart automatically and CP1L-EL datapoint is added successfully.

5.2.3.3 Uploading Data to Various Clouds

BL102 collects data of different protocols. The configuration procedures of uploading data to various clouds are the same. Here only introduce configuration of collecting PLC data and send it to various clouds. Refer to [5.4 Configuration of Uploading Data to Various Clouds](#)

5.2.4 Collecting Delta PLC Data

5.2.4.1 Add Delta PLC to COM Port

Because COM2 and COM3 of DVP-12SA2 are both RS485 ports, DVP-12SA2 COM3+ connect gateway COM A, COM3- is connected to gateway COM B.

5.2.4.1.1 COM Port Configuration

Configure the COM port according to the configuration parameters of DVP-12SA2 COM3, the configuration is as follows:

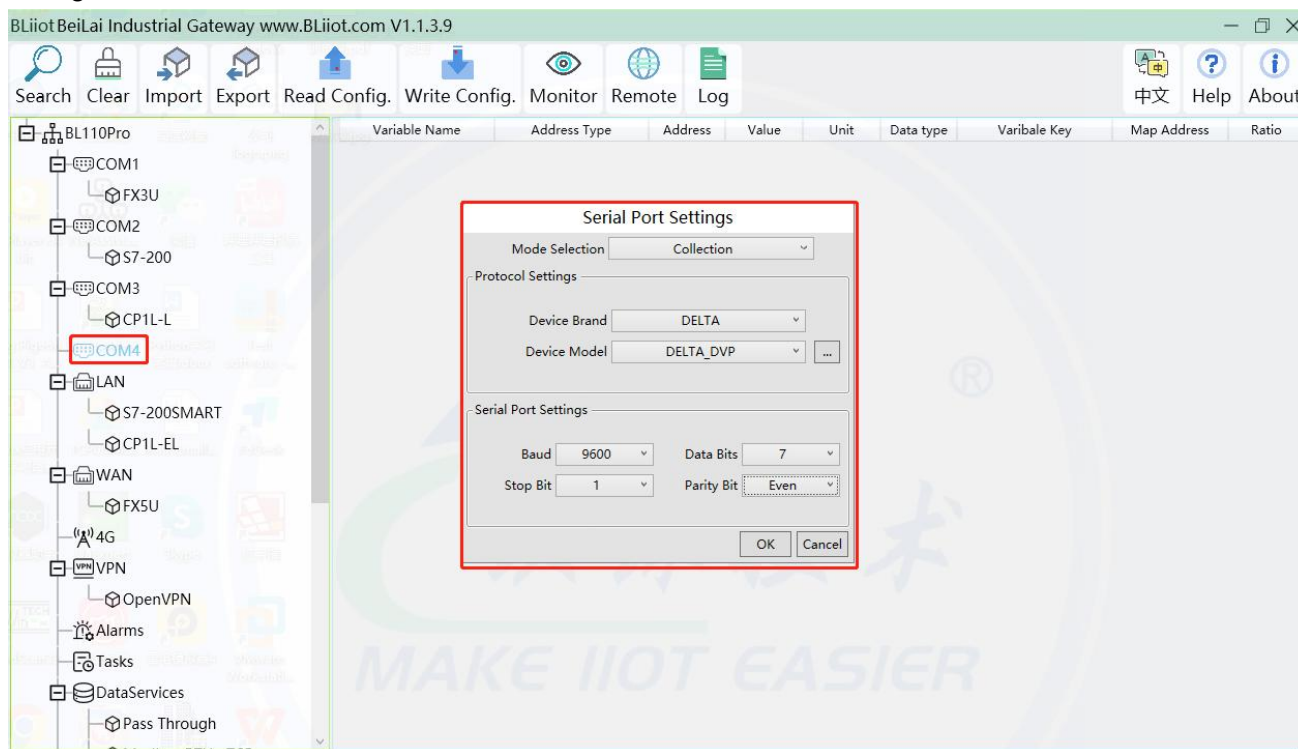

- (1) Double-click "COM" to enter COM configuration box.
- (2) Mode selection: Collection.
- (3) Because it is a collection of Delta DVP-12SA2, the device brand: select DELTA from the drop-down box, and the device model: DELTA_DVP. The polling interval and communication timeout in the button are set according to requirements.
- (4) The baud rate, stop bit, data bit and parity bit are configured according to the parameters of the

COM3 port of DVP-12SA2, which are consistent with them. DVP-12SA2 COM3 port parameters
Baud rate: 9600, stop bit: 1, data bit: 7, parity bit: Even.

(5) Click "OK".

Note: Click "Write Configuration" and the gateway device will restart automatically, and the configuration of the COM port will take effect after restarting.

5.2.4.1.2 Add DVP-12SA2 to COM Port

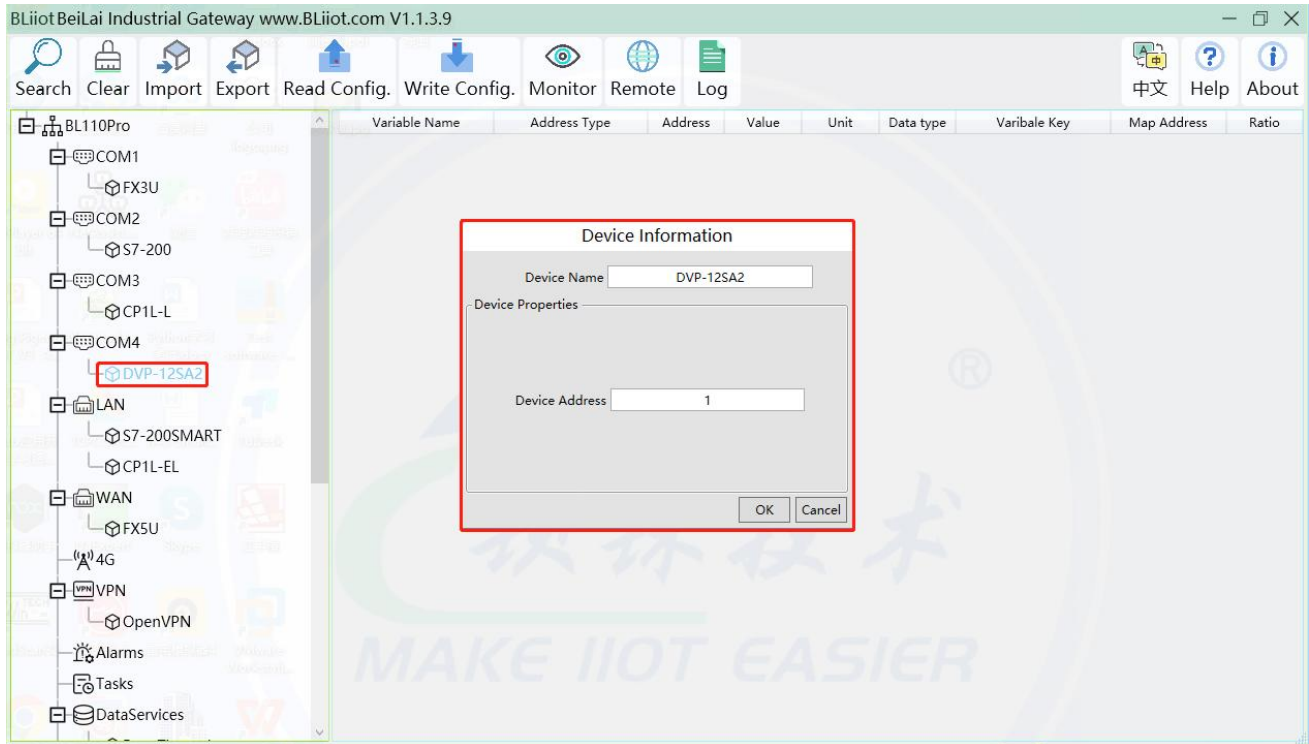

(1) Click "COM", click the right mouse button, click "Add", to enter device configuration box.

(2) Fill in the device name arbitrarily, such as: DVP-12SA2.

(3) Device address: The station number of Delta COM, fill in as required, the address must be consistent with the Delta COM setting, otherwise communication will fail.

(4) Click "OK" to add DVP-12SA2 device.

Note: After clicking OK, the added devices will be displayed under COM, as shown in the figure above. DVP-12SA2, if you want to add multiple devices, repeat steps (1)-(4).

Note: Clicking "Write Configuration" will restart the gateway device automatically. After restarting, the DVP-12SA2 device with COM4 port added will be added successfully.

5.2.4.1.3 Add DVP-12SA2 Data Point

Taking adding data points Y0 and D0 as an example, the address of register X and Y of Delta DVP-12SA2 is octal, and the address of register D is decimal.

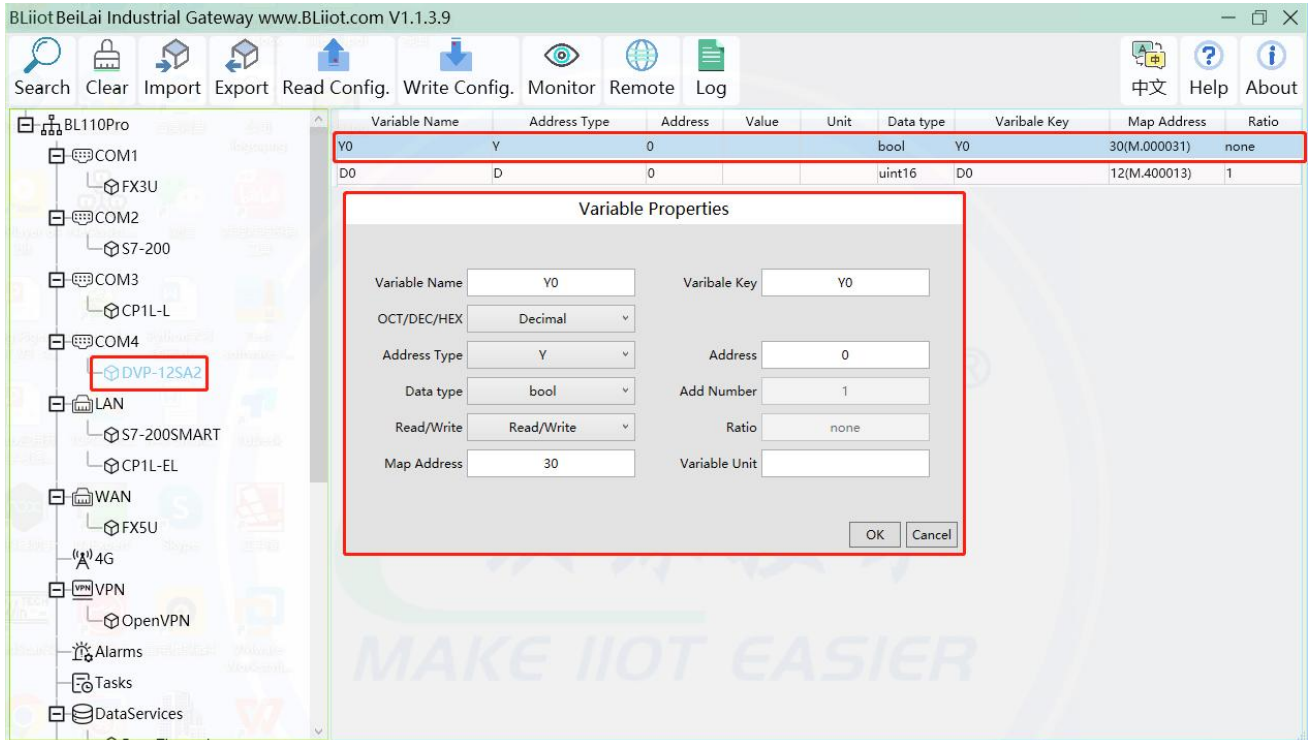

- (1) Click "DVP-12SA2", move the mouse cursor to the box, right-click the mouse, and click "Add" to enter data point setting box.
- (2) Variable name: Name the data point, such as: Y0.
- (3) The identifier of the data point can be filled in arbitrarily. The identifier cannot be repeated, for example, the identifier of the Y0 data point is filled in as Y0.
- (4) Select the collection address data format filled in the input gateway according to the requirements. OCT/DEC/HEX are octal/decimal/hexadecimal respectively. Register X and Y addresses are in octal, and register D addresses are in decimal.
- (5) Address type: according to Delta's register selection, if you want to collect "Y0", select "Y".
- (6) Address: The register address of the collected data point, such as: collecting "Y0", so fill in "0".
- (7) Data type: Select according to the acquisition PLC register, such as: "Y0" is the coil type, so select "bool".
- (8) Add Number: The number of acquisitions. If it is to acquire continuous addresses, the same register can be acquired multiple times.
- (9) Read/Write: according to PLC register selection. Select from "Read Only", "Read and Write".
- (10) Map address: Fill in the address where the collected data points are stored to the BL102 gateway device, which can be filled in at will. Mapped addresses cannot be duplicated. Range: 0-2000. For example, the data collected from Y0 is stored in the "0" register address of the BL102 gateway. The outside of the mapping address on the configuration software represents the Modbus address, and M.XXX in the brackets represents the PLC Modbus address.
- (11) Variable unit: fill in arbitrarily according to requirements, or not fill in.
- (12) Click "OK".

Note: After clicking "OK", the data points will be displayed in the box as shown in the figure above. If you want to continue adding data points, right-click on the box and click "Add" to enter data point

configuration box, repeat (1)--(12) Steps.

Note: Clicking "Write Configuration" will restart the gateway automatically, and the data points added by DVP-12SA2 will take effect only after restarting.

5.2.4.2 Add Delta PLC to Ethernet Port

5.2.4.3 Uploading Data to Various Clouds

BL102 collects data of different protocols. The configuration procedures of uploading data to various clouds are the same. Here only introduce configuration of collecting PLC data and send it to various clouds. Refer to [5.4 Configuration of Uploading Data to Various Clouds](#)

5.3 Collecting Watt-Hour Meter Data

Supports DL/T645-2007 protocol meters now

IEC101 104 waiting for development

5.3.1 Adding Watt-Hour Meter to COM Port

5.3.1.1 COM Port Configuration

5.3.1.2 Add Watt-hour Meter to COM Port

5.3.1.3 Add COM Port Watt-hour Meter Datapoint

5.3.2 Add Wat-hour Meter to Ethernet Port

5.3.3 Uploading Data to Various Clouds

5.4 Configuration of Uploading Data to Various Clouds

Below is the example of connecting Mitsubishi PLC FX3U to BL102 COM1 port and connecting Siemens PLC S7-200SMART to BL102 LAN port. Other PLC hardware connection methods are the same as COM port acquisition of Mitsubishi's FX3U, LAN port acquisition of Siemens S7-200SMART mode, only need to configure the "device brand" and "device model" of the software to select the corresponding PLC to collect data. BL102 WAN port is connected to router R40 LAN port. R40 provides network for BL102. See below wiring diagram:

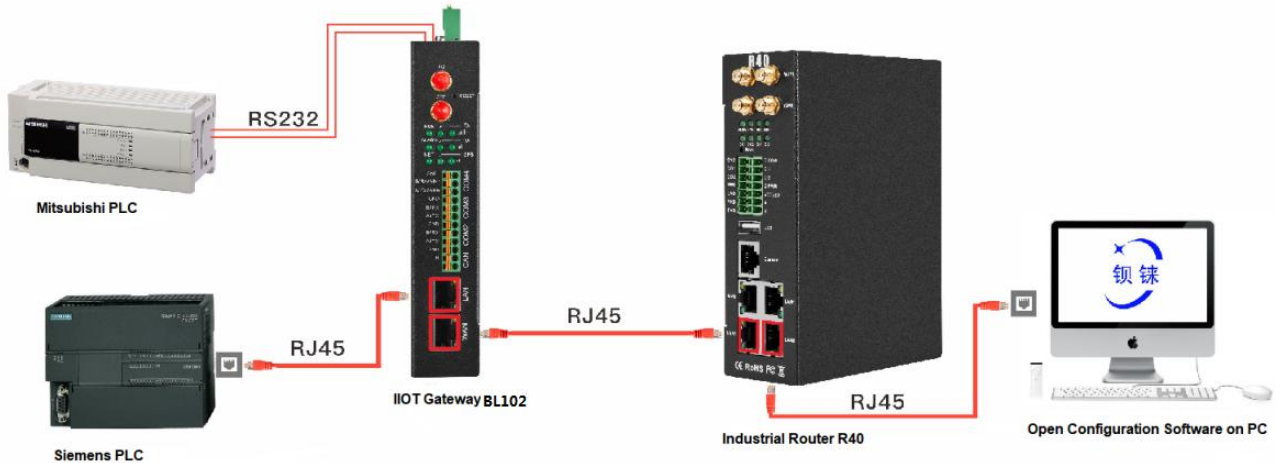

BL102 LAN port is connected to Siemens PLC S7-200SMART Ethernet port, COM is connected to Mitsubishi PLC FX3U via RS232 to RS422 converting cable. BL102 collects both PLC data and send to various clouds with network provided by R40 through WAN.

Note: Both WAN and LAN ports can collect device data. This example is collecting data through LAN port. WAN and LAN port configurations are the same as stated in previous introduction.

Below is only the introduction to cloud connection configuration

5.4.1 Modbus TCP Server Configuration

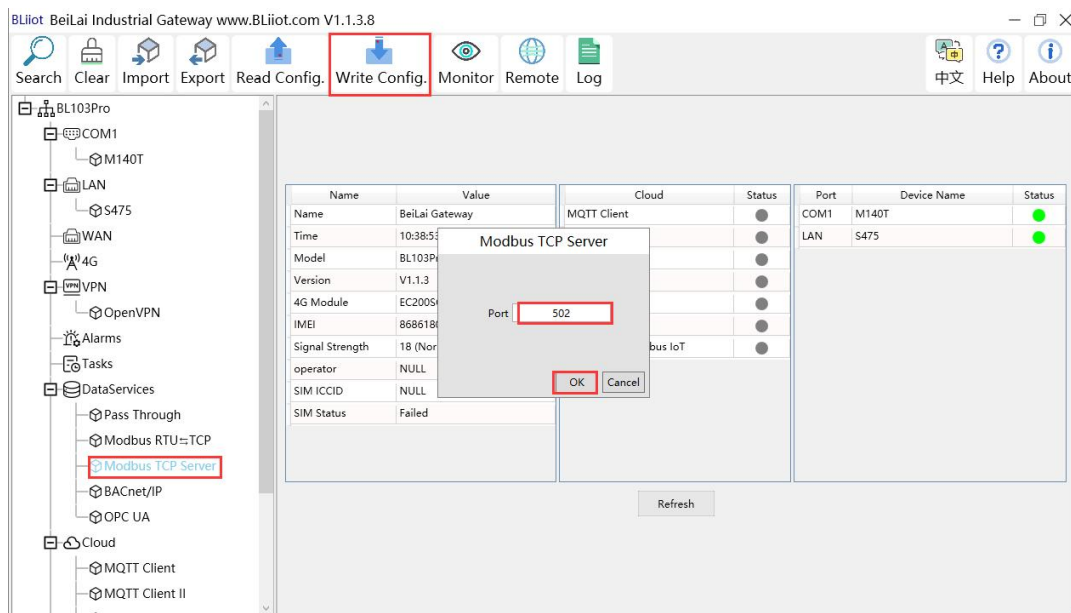

- (1) Double click Modbus TCP Server to enter configuration box
- (2) Port: This gateway is used as Modbus TCP Server monitoring port. Input any port within range 1-65535. For example, put 502
- (3) Click OK to confirm the setting of Modbus TCP Server.
- (4) Click Write Configuration. Gateway will restart automatically. After restarting, Modbus TCP Server configuration is done successfully.

The Modbus TCP Server has enabled the "502" port by default, which can be directly connected to the upper computer acquisition gateway through WAN or LAN. If the parameters of the port are not modified, no operation is required.

5.4.1.1 View and Send Command with KingView

Gateway provides data as Modbus TCP server. Modbus TCP host computer will collect data from BL102, like SCADA, MES host PCs. Function codes supported for collecting gateway data: 01 & 05 for boolean data; 03 & 06 for numerical data. Below example is using KingView to view BL102 device data. WAN port IP: 192.168.1.155, Modbus TCP Server port: 502

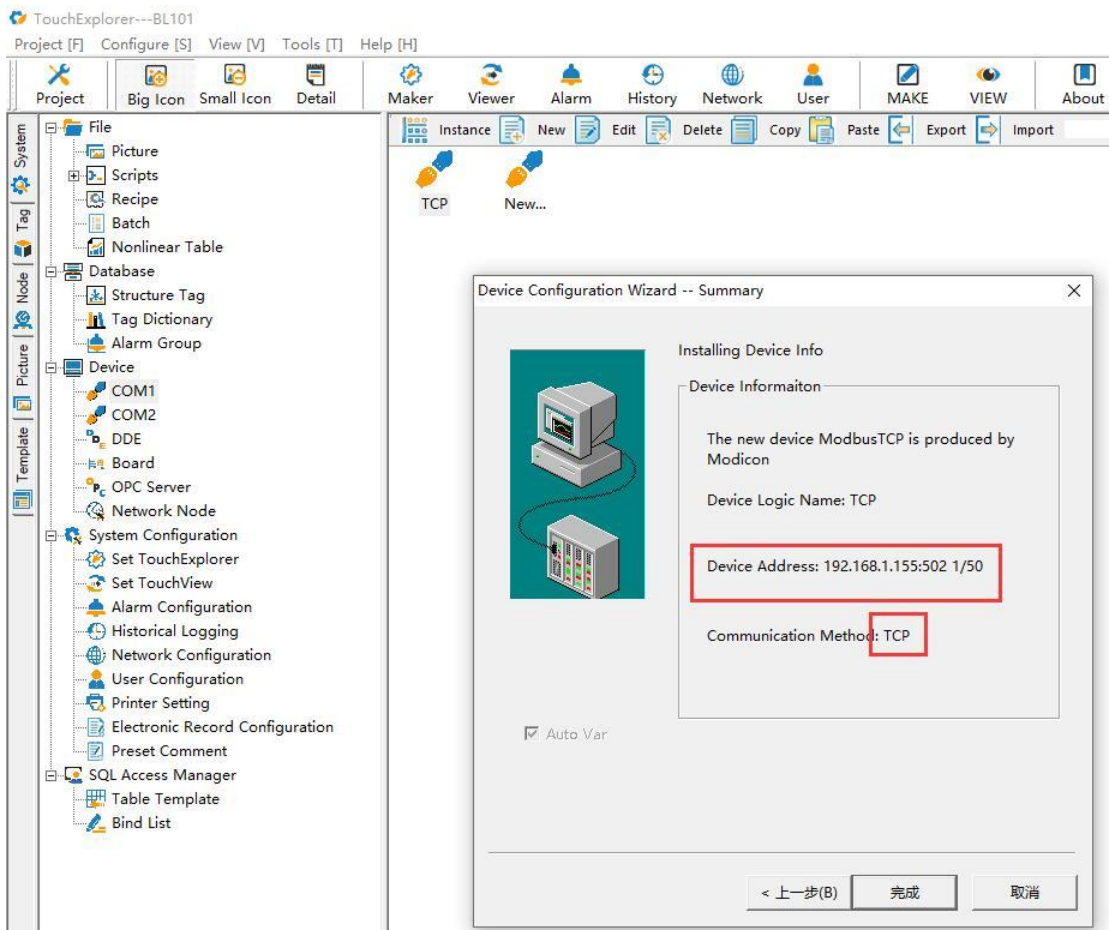

BLIiot BeiLai Industrial Gateway www.BLIiot.com V1.1.3.8

Variable Name	Address Type	Address	Value	Unit	Data type	Variable Key	Map Address	Ratio
DO1	01 Coil Status(0x)	0	True		bool	DO1	0(M.000001)	none
DO2	01 Coil Status(0x)	1	True		bool	DO2	1(M.000002)	none
DO3	01 Coil Status(0x)	2	False		bool	DO3	2(M.000003)	none
DO4	01 Coil Status(0x)	3	False		bool	DO4	3(M.000004)	none
DO5	01 Coil Status(0x)	4	False		bool	DO5	4(M.000005)	none
DO6	01 Coil Status(0x)	5	False		bool	DO6	5(M.000006)	none
DO7	01 Coil Status(0x)	6	False		bool	DO7	6(M.000007)	none
DO8	01 Coil Status(0x)	7	False		bool	DO8	7(M.000008)	none
DIN1	02 Input Status(1x)	0	True		bool	DIN1	8(M.000009)	none
DIN2	02 Input Status(1x)	1	True		bool	DIN2	9(M.000010)	none
DIN3	02 Input Status(1x)	2	True		bool	DIN3	10(M.000011)	none
DIN4	02 Input Status(1x)	3	True		bool	DIN4	11(M.000012)	none
DIN5	02 Input Status(1x)	4	True		bool	DIN5	12(M.000013)	none
DIN6	02 Input Status(1x)	5	True		bool	DIN6	13(M.000014)	none
DIN7	02 Input Status(1x)	6	True		bool	DIN7	14(M.000015)	none
DIN8	02 Input Status(1x)	7	True		bool	DIN8	15(M.000016)	none

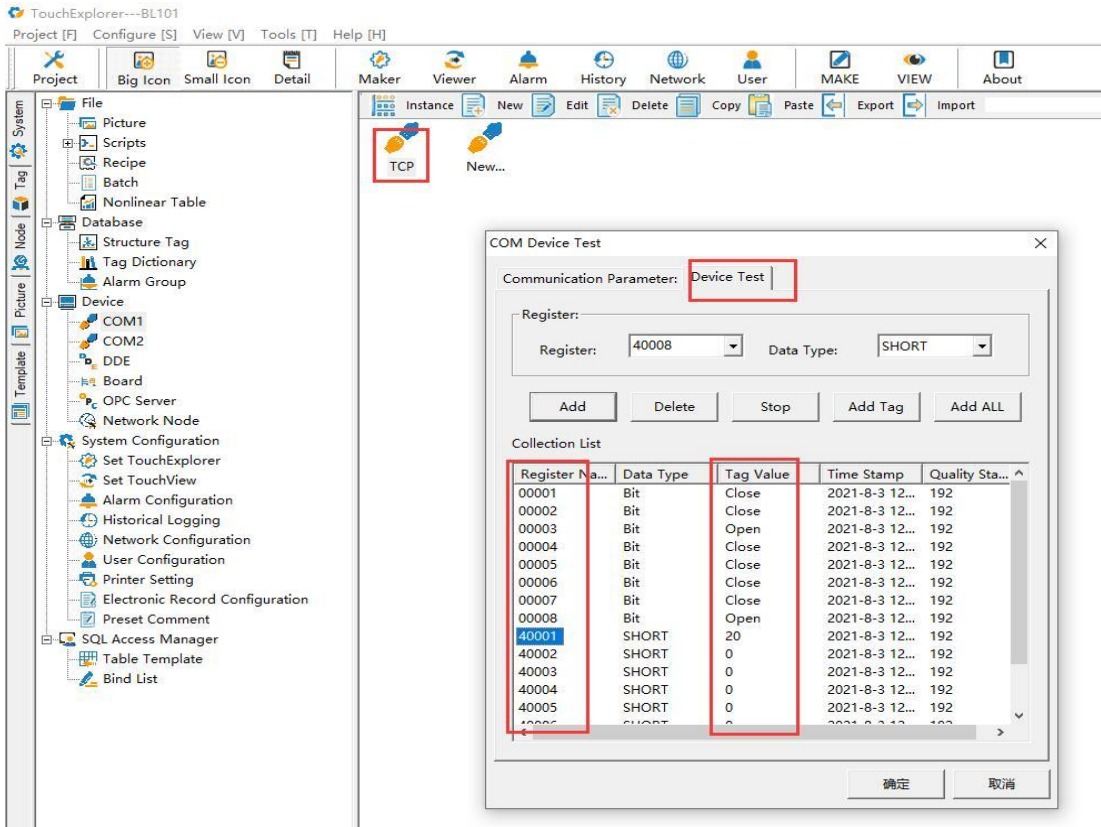

Send command from cloud to control device

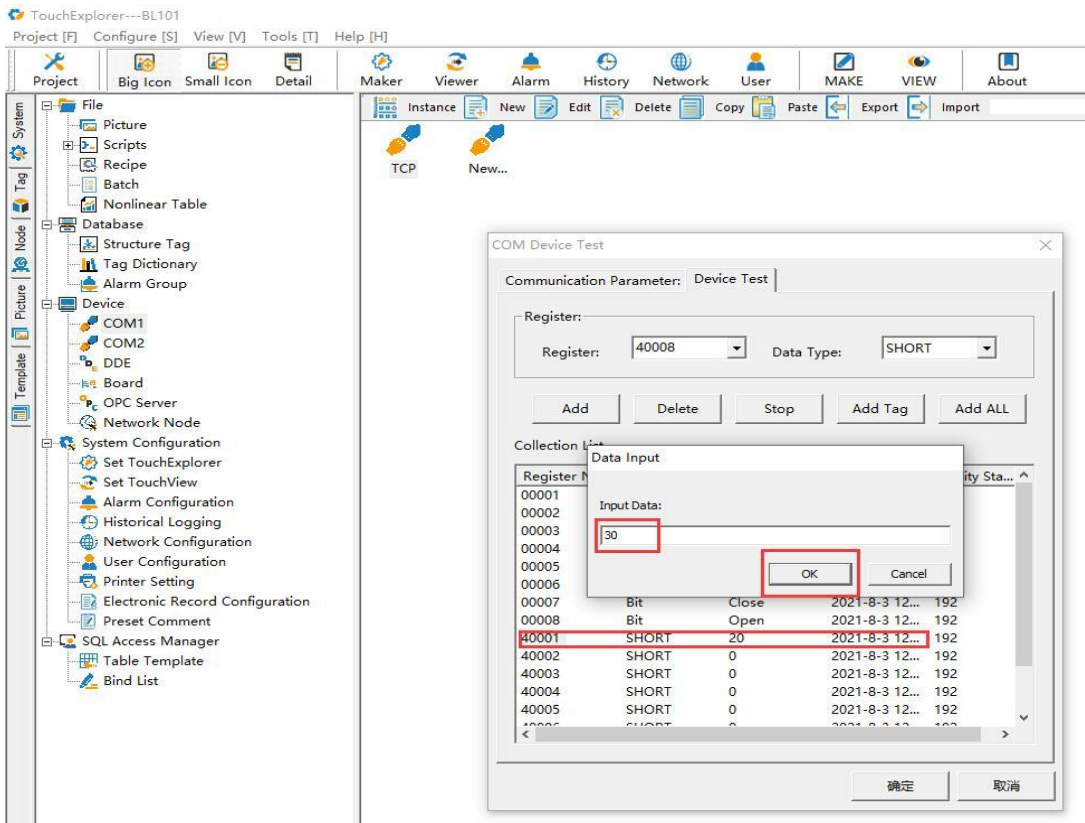

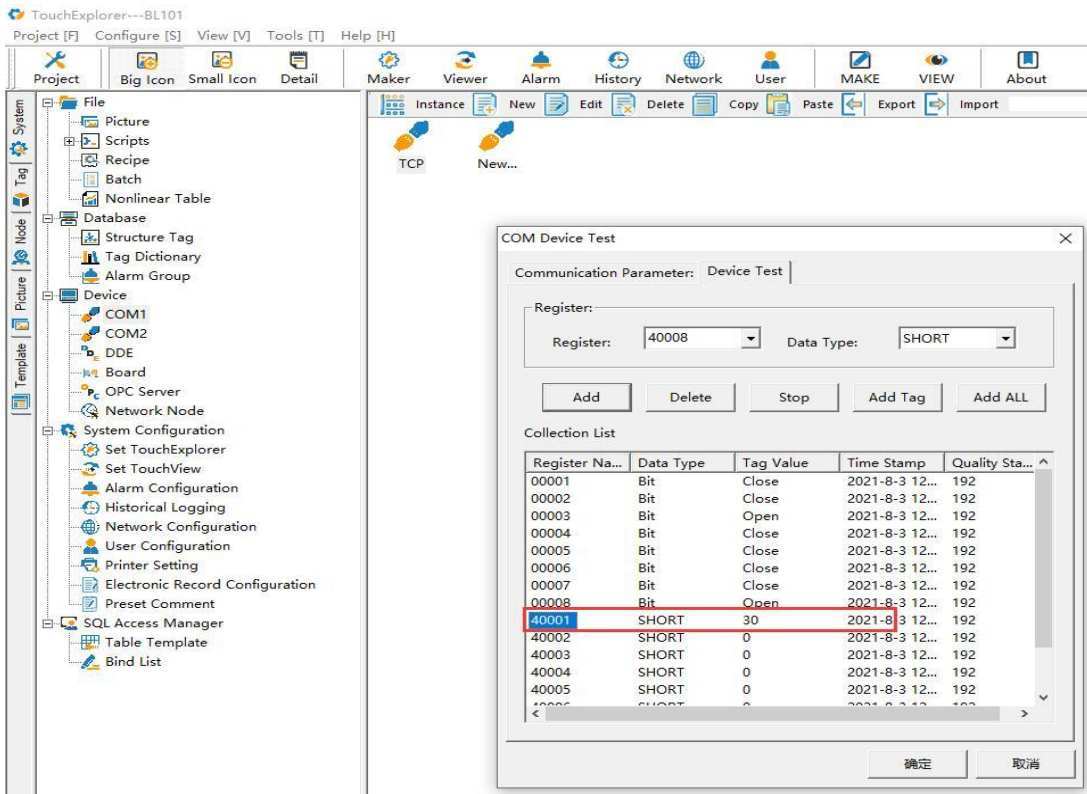

5.4.2 OPC UA Configuration

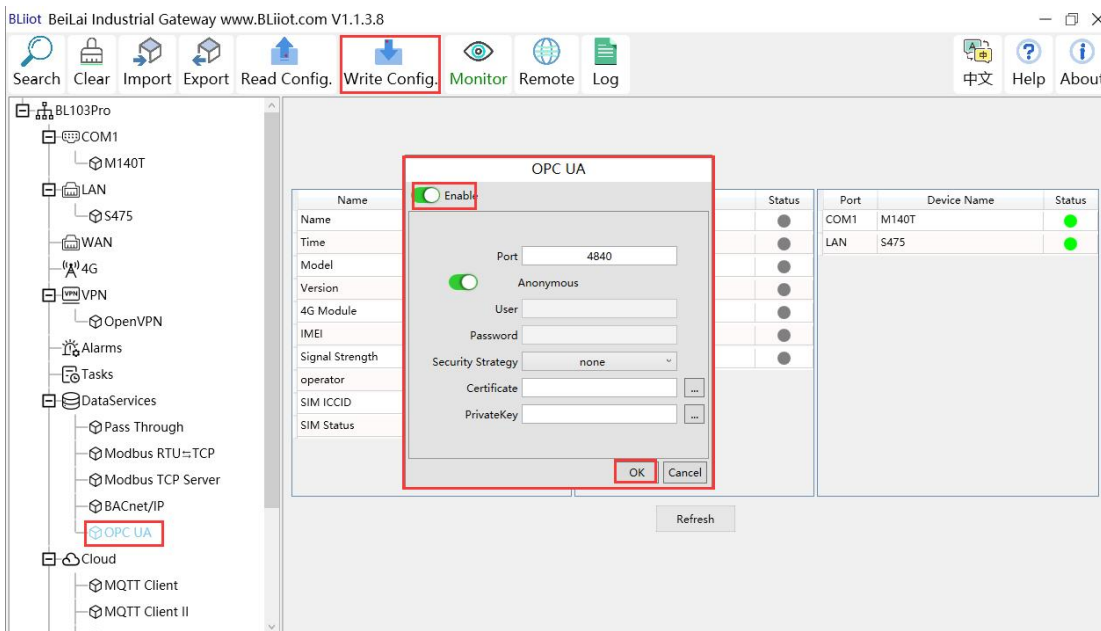

- (1) Double click OPC UA to enter configuration box
- (2) Click Enable to enable (green color) OPC UA. Default is disabled (gray color).
- (3) Port: OPC UA Port, default is 4840

- (4) Anonymous: If enabled, OPC UA can be connected without ID and password
- (5) User, Password: only to be set when anonymous is disabled
- (6) Security Policy: Select connection encryption policy(This example is connecting without encryption, thus select None)
- (7) Certificate, PrivateKey: This example is connecting without encryption, then it's not necessary to upload certificate and privatekey.
- (8) Click OK to confirm OPC UA configuration
- (9) Click Write Configuration. Gateway will restart automatically. After device restarting, OPC UA is configured successfully.

5.4.2.1 View and Send Command with UaExpert

BL102 provides data as OPC UA server. Below is the example of collecting BL102 data with UaExpert(OPC UA Client). Connecting UaExpert with BL102 OPC UA server. Datapoint will be generated automatically. Datapoint names are the same as variable names in configuration software. Node id Consists of the device name on the configuration software and the device's data point label.

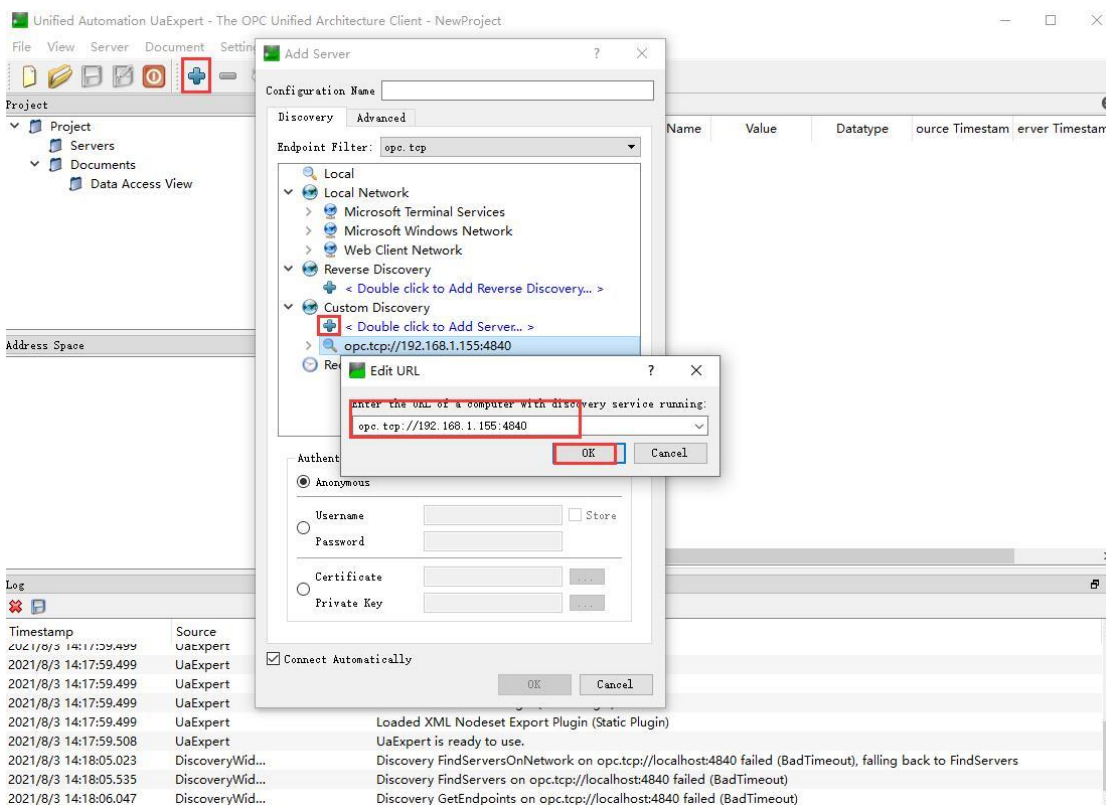

5.4.3 MQTT Client Configuration

The "KingPigeon" JSON data format of MQTT Client and MQTT Client II is the same as King Pigeon MQTT. Refer to: [King Pigeon MQTT Data Format](#)

Connect to the ThingsBoard platform, select the JSON data format in the "thingsboard-telemetry-gateway" format. The ThingsBoard platform domain name is thingsboard.cloud.

Connect to a platform that supports Sparkplug B, such as the ignition platform, select the JSON data format in the "sparkplug b" format, click the button next to the data template item, enter configuration box to configure the group ID and edge node ID.

The difference between MQTT Client and MQTT Client II is that the subscription topic of MQTT Client II does not work. The purpose of MQTT Client II is that the platform can view the data but cannot control the data. Therefore, MQTT Client II connection is not introduced.

The configuration of MQTT Client is as follows: Connection without certificate and the JSON data format in KingPigeon format as an example.

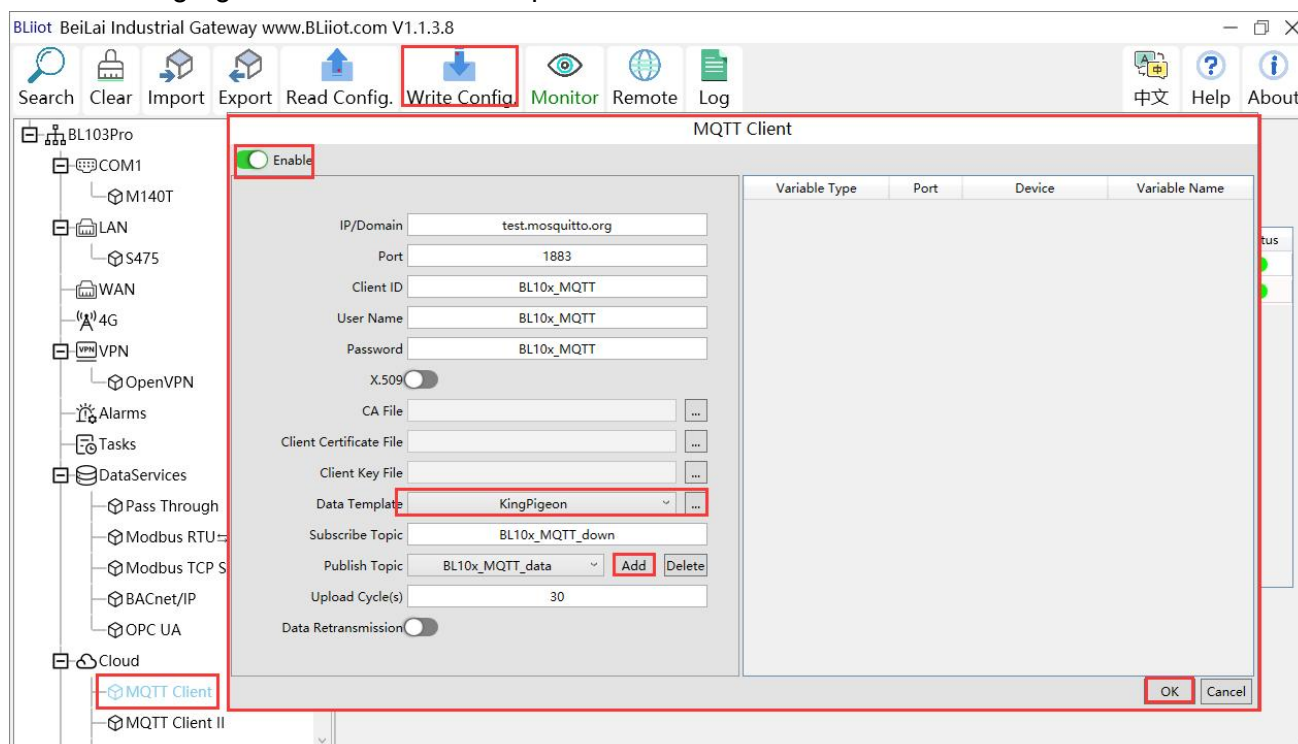

- (1) Double-click "MQTT Client" to enter configuration box.
- (2) Click the Enable button to enable MQTT Client. Default: off. Gray: Disabled, Green: enabled.
- (3) IP/domain: fill in the IP/domain name of the MQTT server.
- (4) Port: Fill in the MQTT server port, Default: 1883.
- (5) Client ID: The client identifier used in the MQTT connection message, and the server uses the client identifier to identify the client.
- (6) Username: The username used in the MQTT connection message, the server can use it for authentication and authorization.
- (7) Password: The password used in the MQTT connection message, which can be used by the server for authentication and authorization.
- (8) Data template: Select according to the JSON data format supported by the MQTT server, default is "KingPigeon".
- (9) Subscribe topic: The topic name used by the MQTT subscription message. After subscription, the

server can send a publish message to the client for control. (10) Publish topic: The topic name used by MQTT to publish the message. The topic name is used to identify which information channel the payload data should be published to. (11) Upload cycle: The interval for regular data release, default is 30S. (12) Data retransmission: whether to enable data retransmission, Gray: disabled, Green: enabled. (13) Select data point upload: select the data point to be uploaded in the box on the right side of the configuration box, the default is blank means all upload. (14) Click "OK" to confirm the configuration of King Pigeon MQTT. (15) Click "Write Configuration", the MQTT Client will not be enabled until the gateway device restarts. Re-open the configuration software to log in to the device, and you can see on the basic information page that the prompt light of "MQTT Client Online Status" is green, indicating that the MQTT Client is connected. The rightmost shows the online status of the slave device.

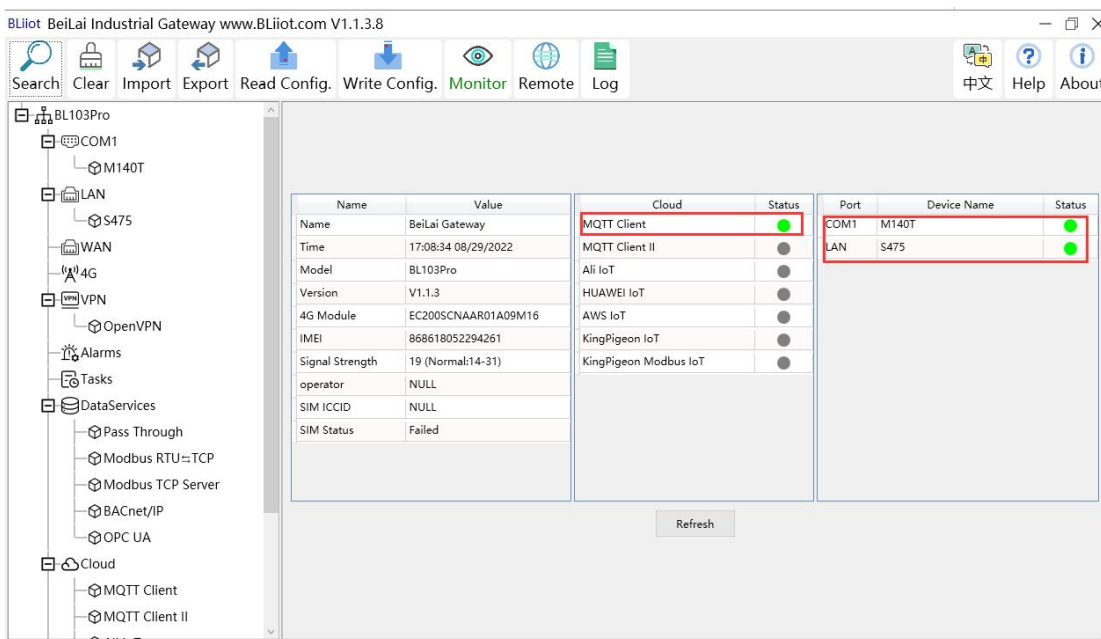

5.4.3.1 View and Send Command with MQTT.fx

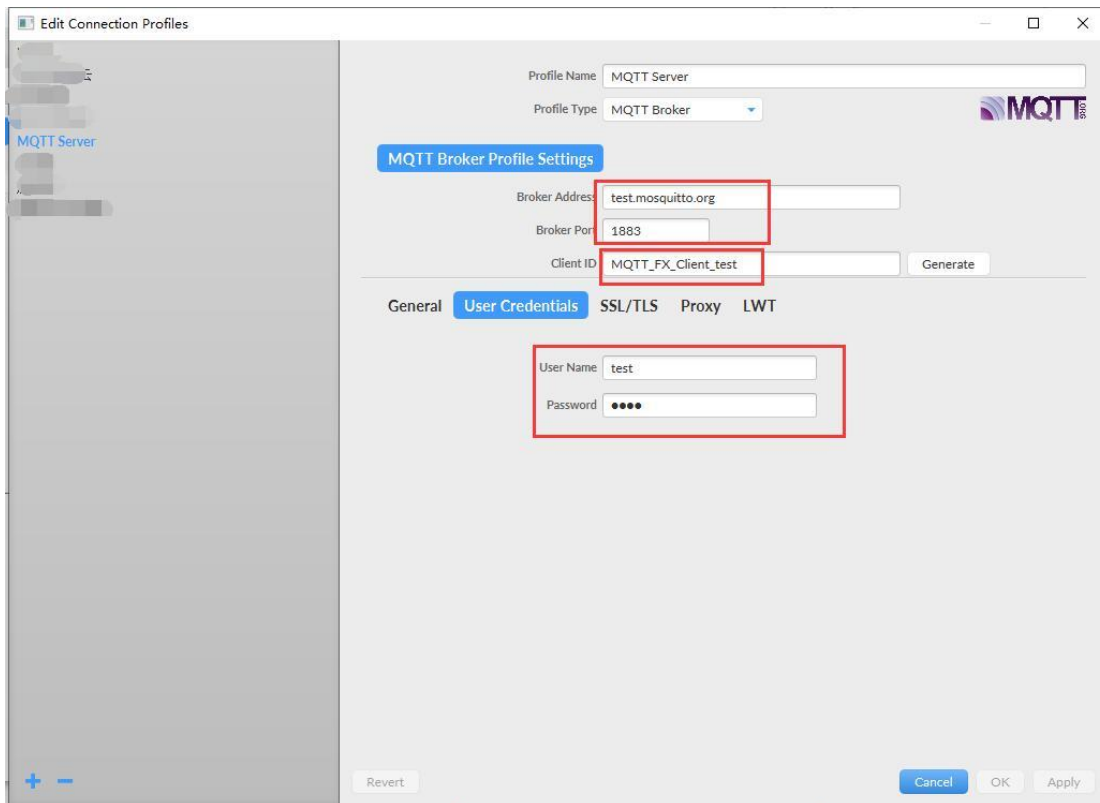

MQTT Server

Profile Name: MQTT Server

Profile Type: MQTT Broker

MQTT Broker Profile Settings

Broker Address: test.mosquitto.org

Broker Port: 1883

Client ID: MQTT_FX_Client_test

Generate

General **User Credentials** SSL/TLS Proxy LWT

User Name: test

Password: ••••

Revert Cancel OK Apply

Note: Client ID can not be the same the Client ID in configuration software

Message received in MQTT.fx:

Subscription Topic of MQTT.fx is the Publishing Topic configured in MQTT Client

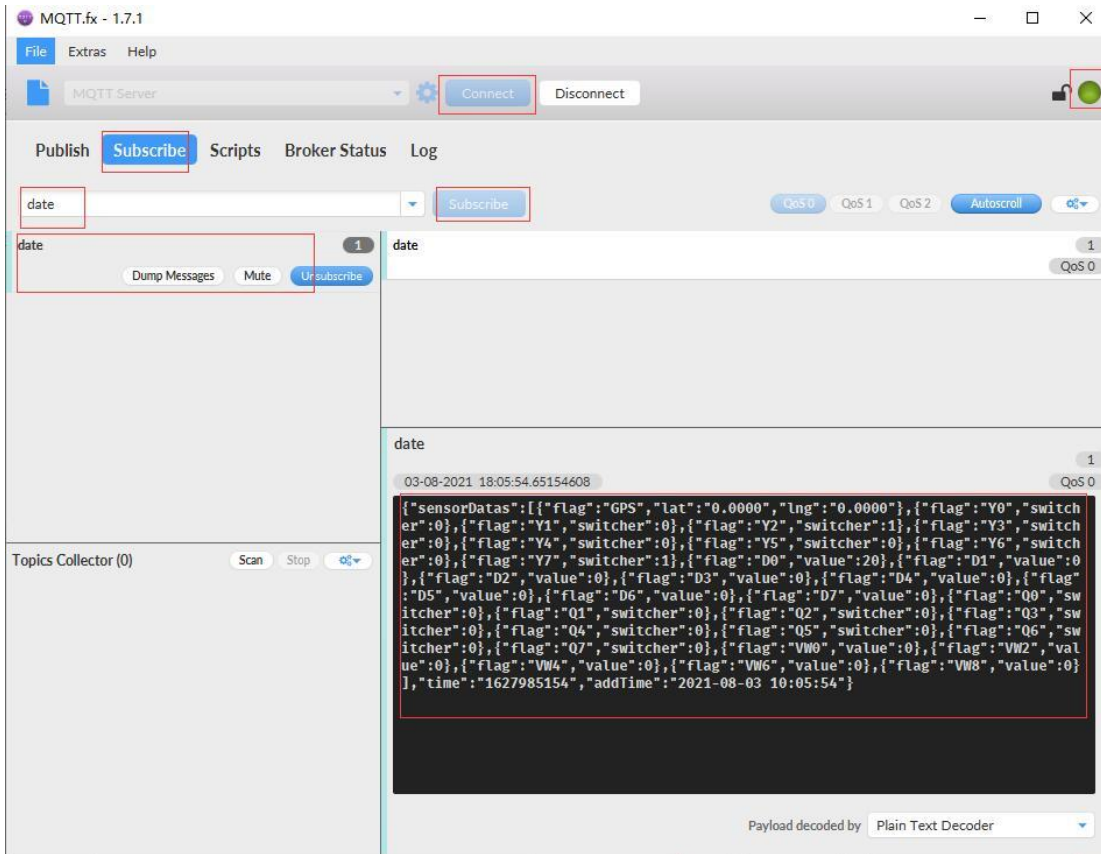

Use MQTT.fx to publish:

Public Topic is the Subscription Topic Configured in MQTT Client

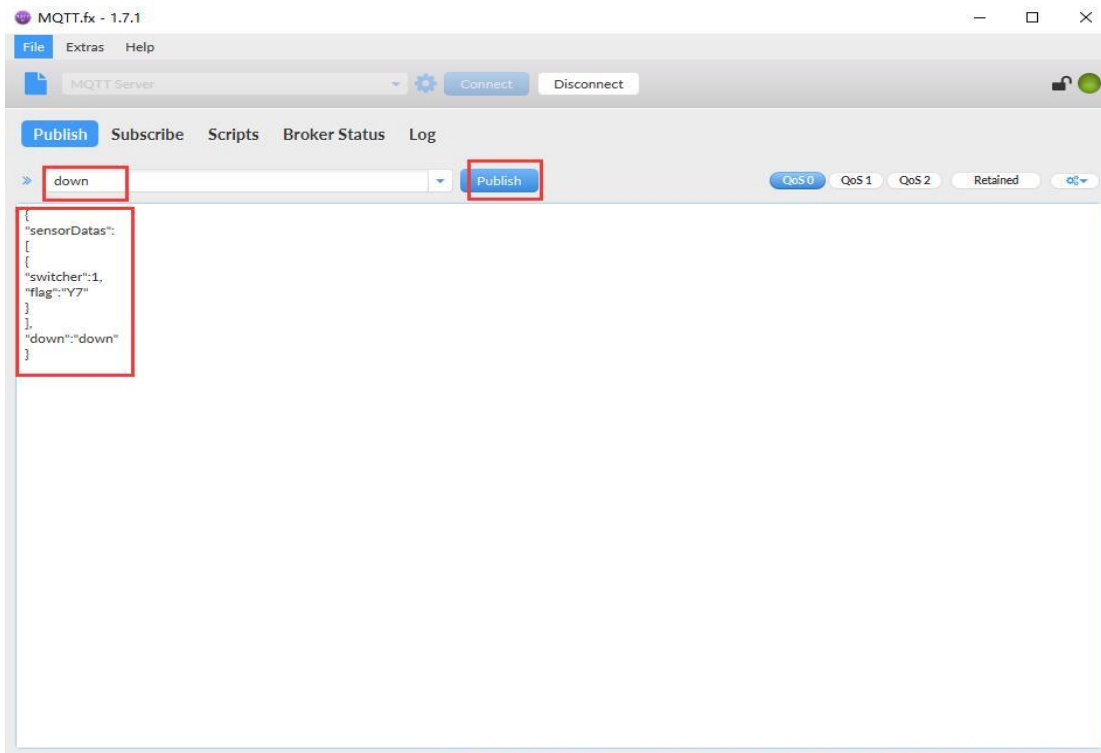

MQTT.fx - 1.7.1

File Extras Help

MQTT Server [Connect] [Disconnect]

Publish Subscribe Scripts Broker Status **Log**

```

}
to topic down (QoS 0, Retained: false)
2021-08-04 17:48:35,908 INFO --- MqttFX ClientModel : messageArrived() with topic: date
2021-08-04 17:48:35,908 INFO --- MqttFX ClientModel : messageArrived() added: message #2 to topic 'date'
2021-08-04 17:48:41,630 INFO --- BrokerConnectorController : onDisconnect
2021-08-04 17:48:41,631 INFO --- MqttFX ClientModel : rebuildMessagesList()
2021-08-04 17:48:41,632 INFO --- ScriptsController : Clear console.
2021-08-04 17:48:41,632 INFO --- ScriptsController : Cancel script execution.
2021-08-04 17:48:41,632 INFO --- ScriptsController : Cancel script execution.
2021-08-04 17:48:41,642 INFO --- ScriptsController : Clear console.
2021-08-04 17:48:41,643 INFO --- ScriptsController : Clear console.
2021-08-04 17:48:41,645 INFO --- ScriptsController : Cancel script execution.
2021-08-04 17:50:04,047 INFO --- BrokerConnectorController : onConnect
2021-08-04 17:50:04,047 INFO --- ScriptsController : Clear console.
2021-08-04 17:50:04,052 INFO --- MqttFX ClientModel : MqttClient with ID MQTT_FX_Client_test assigned.
2021-08-04 17:50:05,194 INFO --- MqttFX ClientModel : session present: false
2021-08-04 17:50:07,359 INFO --- SubscribeController : onSubscribe
2021-08-04 17:50:07,784 INFO --- MqttFX ClientModel : rebuildMessagesList()
2021-08-04 17:50:07,784 INFO --- MqttFX ClientModel : attempt to addRecentSubscriptionTopic
2021-08-04 17:50:07,784 INFO --- MqttFX ClientModel : addRecentSubscriptionTopic : de.jensd.mqttfx.entities.Topic@455
2021-08-04 17:50:07,784 INFO --- MqttFX ClientModel : attempt to add PublishTopic
2021-08-04 17:50:07,786 INFO --- MqttFX ClientModel : successfully subscribed to topic date (QoS 0)
2021-08-04 17:50:18,380 INFO --- MqttFX ClientModel : messageArrived() with topic: date
2021-08-04 17:50:18,381 INFO --- MqttFX ClientModel : messageArrived() added: message #1 to topic 'date'
2021-08-04 17:50:26,190 INFO --- PublishController : publish
2021-08-04 17:50:26,191 INFO --- MqttFX ClientModel : attempt to add PublishTopic
2021-08-04 17:50:26,191 INFO --- MqttFX ClientModel : successfully published message {
sensorDats":
switcher":1,
flag":"Y7"
down":"down"
to topic down (QoS 0, Retained: false)

```

MQTT.fx - 1.7.1

File Extras Help

MQTT Server [Connect] [Disconnect]

Publish **Subscribe** Scripts Broker Status Log

date [Subscribe] QoS 0 QoS 1 QoS 2 Autoscroll

date 4 [Dump Messages] [Mute] [Unsubscribe]

Topics Collector (0) [Scan] [Stop]

date 1 QoS 0

```

04-08-2021 17:50:18.64218381
{"sensorDats":[{"flag":"GPS","lat":"0.0000","lng":"0.0000"},{"flag":"Y0","switcher":0}, {"flag":"Y1","switcher":0}, {"flag":"Y2","switcher":0}, {"flag":"Y3","switcher":0}, {"flag":"Y4","switcher":0}, {"flag":"Y5","switcher":0}, {"flag":"Y6","switcher":0}, {"flag":"Y7","switcher":0}, {"flag":"D0","value":0}, {"flag":"D1","value":0}, {"flag":"D2","value":0}, {"flag":"D3","value":0}, {"flag":"D4","value":0}, {"flag":"D5","value":0}, {"flag":"D6","value":0}, {"flag":"D7","value":0}, {"flag":"Q0","switcher":1}, {"flag":"Q1","switcher":0}, {"flag":"Q2","switcher":0}, {"flag":"Q3","switcher":0}, {"flag":"Q4","switcher":0}, {"flag":"Q5","switcher":0}, {"flag":"Q6","switcher":0}, {"flag":"Q7","switcher":1}, {"flag":"VW0","value":10}, {"flag":"

```

Payload decoded by Plain Text Decoder

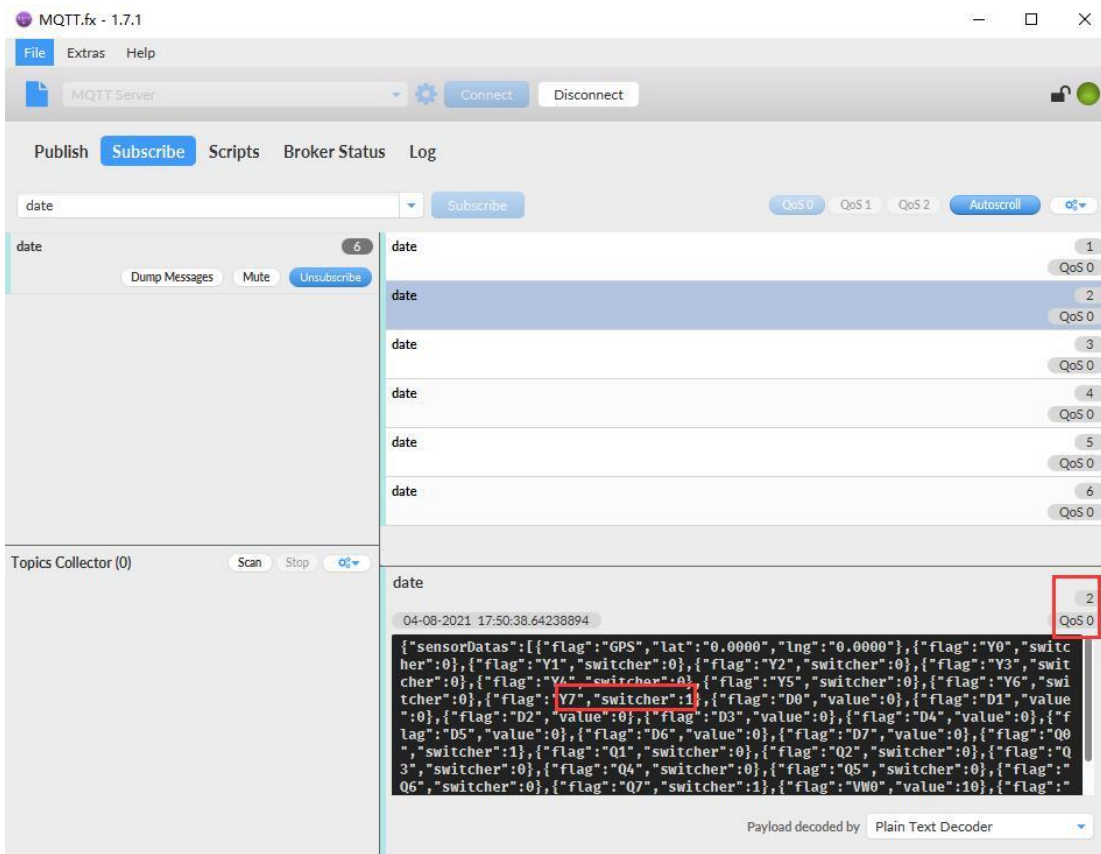

5.4.4 Alibaba Cloud Configuration

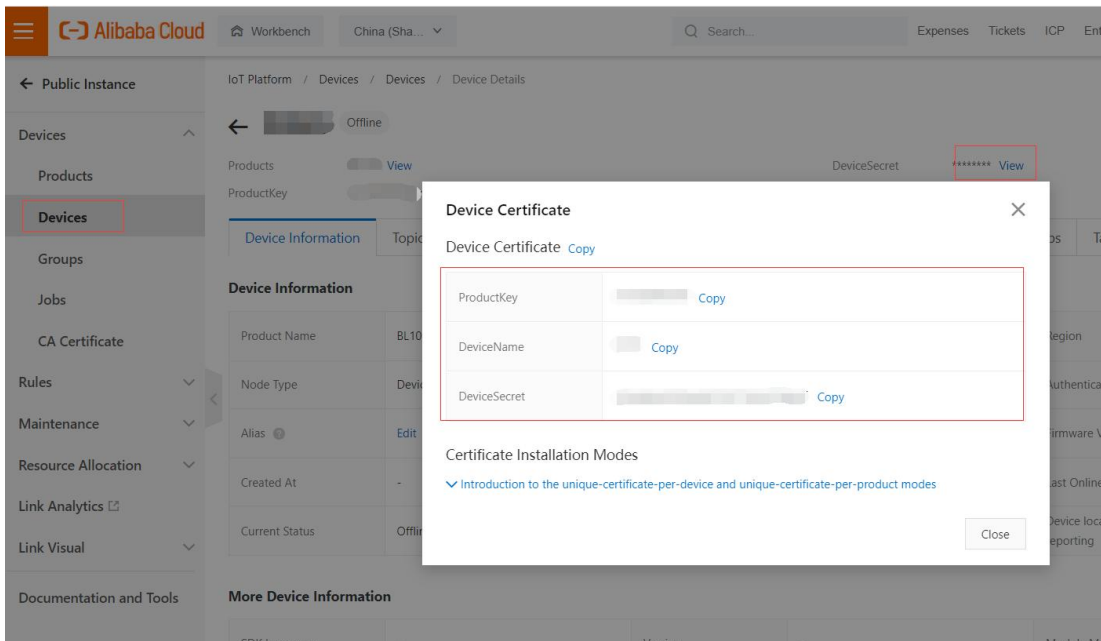

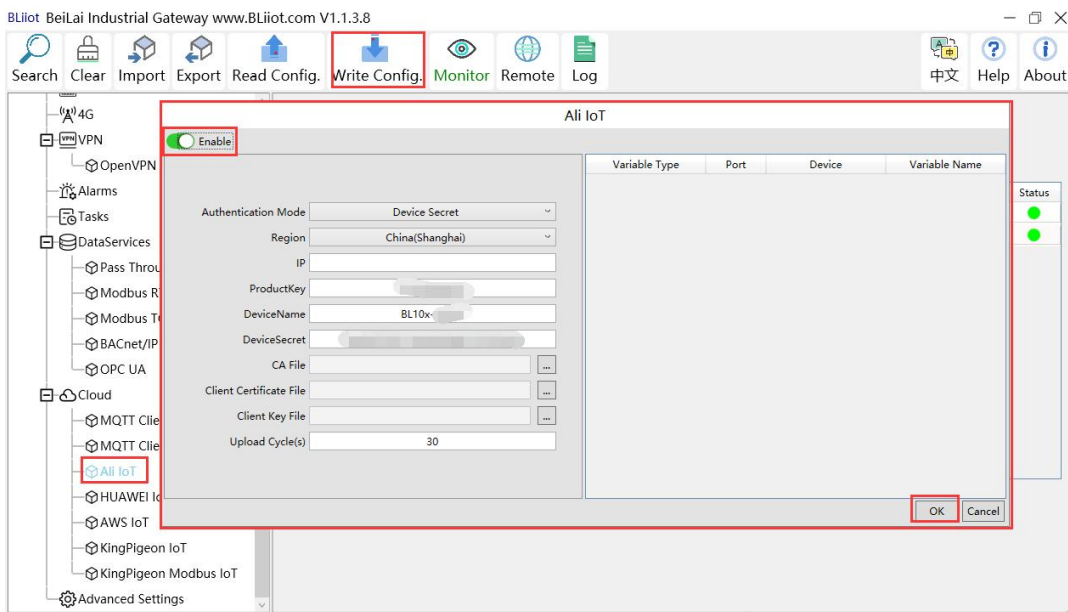

(1) Double-click "Alibaba Cloud IoT" to enter configuration box. (2) Click the Enable button to enable Alibaba Cloud. Default: off. Gray: Disabled, Green: enabled. (3) Authentication mode: Choose whether to use a key connection or a certificate connection. The default is key connection. (4) Region: Select the Alibaba Cloud region, default is China (Shanghai). (5) IP: The IP address of Alibaba Cloud for the enterprise version, don't need to filled in for the public version. (6) ProductKey: The same as the ProductKey in the Alibaba Cloud device. (7) DeviceName: The same as the DeviceName in the Alibaba Cloud device. (8) DeviceSecret: The same as the DeviceSecret in the Alibaba Cloud device. (9) CA file: When enabling certificate connection, select the root certificate file to upload. (10) Client certificate file: When enabling certificate connection, select the client certificate file to upload. (11) Client key file: When enabling certificate connection, select the client key file to upload. (12) Upload cycle: The interval for regular data release, the default is 30S. (13) Select data point upload: select the data point to be uploaded in the box on the right side of the configuration box, the default is blank means all upload. (14) Click "OK" to confirm (15) Click "Write Configuration", and Alibaba Cloud will not be enabled until the gateway device restarts. Re-open the configuration software to log in to the device, and you can see that the "Alibaba Cloud Online Status" indicator light is green on the basic information page, indicating that Alibaba Cloud is connected. The rightmost shows the online status of the slave device.

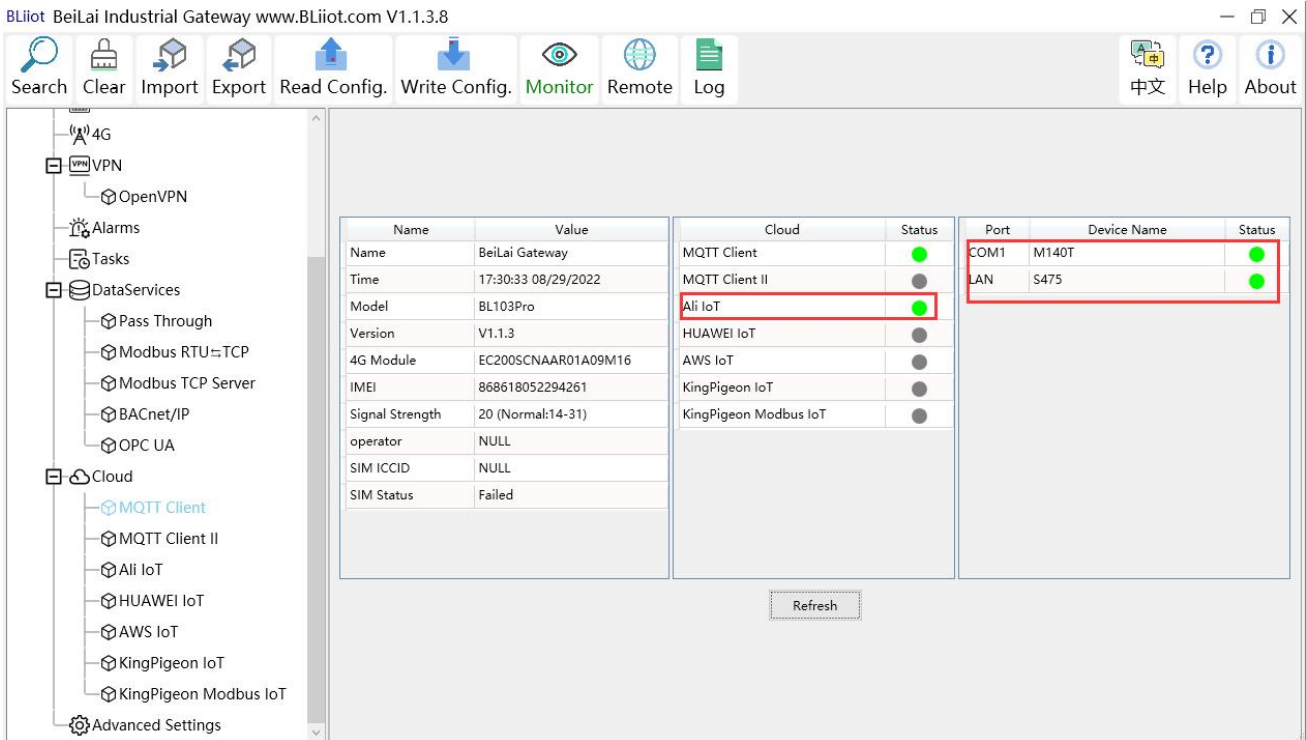

5.4.4.1 View and Send Command in Alibaba Cloud

Add datapoint to Alibaba Cloud as below picture. Make sure datapoint mark is the same as MQTT flag in configuration software. For example, MQTT flag of datapoint VW8 of PLC S7-200SMART is VW8 in configuration software, then set VW8 as datapoint mark in Ali Cloud. Function name and variable name can be different.

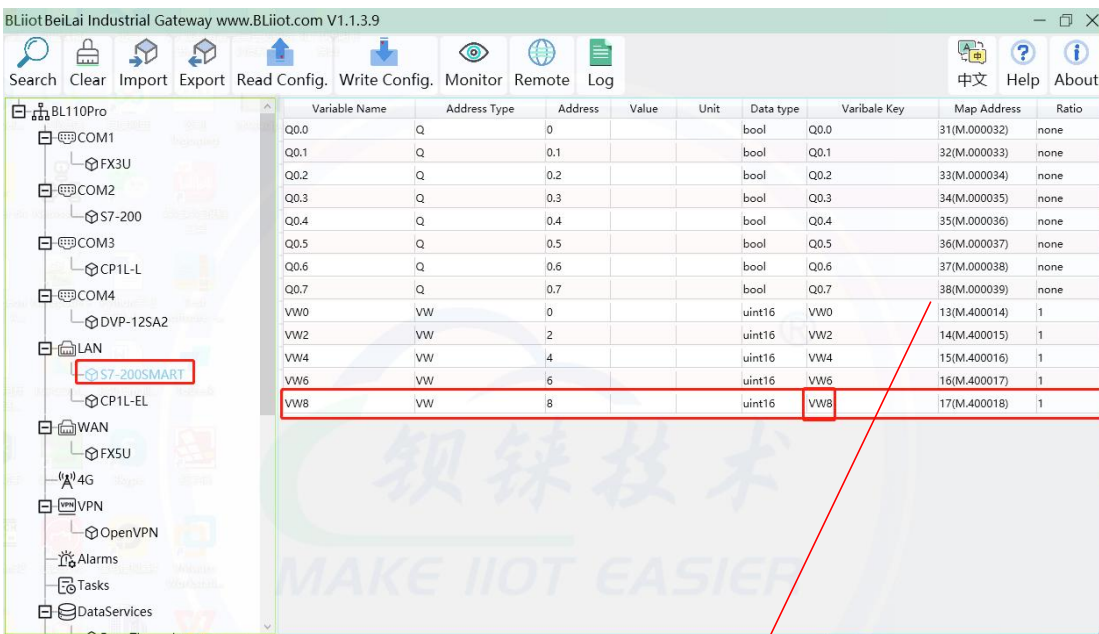

Public Instance > IoT Platform > Devices > Products > Product Details > Define Feature

Edit Draft

Product Name: BL10x-電明 ProductKey: [Copy]

You are editing a draft. You need to click Publish to apply the TSL model.

Import TSL Model Version History

Enter a module name

Default Module

Buttons: Add Standard Feature, Add Self-defined Feature

Feature Type	Feature Name(s)	Identifier	Data Type	Data Definition	Actions
Properties	VW8 (Custom)	VW8	Int32	Value Range: -2147483648 ~ 2147483647	Edit Delete
Properties	VW6 (Custom)	VW6	Int32	Value Range: -2147483648 ~ 2147483647	Edit Delete
Properties	VW4 (Custom)	VW4	Int32	Value Range: -2147483648 ~ 2147483647	Edit Delete
Properties	VW2 (Custom)	VW2	Int32	Value Range: -2147483648 ~ 2147483647	Edit Delete
Properties	VW0 (Custom)	VW0	Int32	Value Range: -2147483648 ~ 2147483647	Edit Delete
Properties	Q7 (Custom)	Q7	Boolean	Boolean value: 0 - 关 1 - 开	Edit Delete
Properties	Q6 (Custom)	Q6	Boolean	Boolean value: 0 - 关 1 - 开	Edit Delete

Buttons: Release online, Back

Data received in Alibaba cloud:

Alibaba Cloud > Wotbench > China (Shanghai)

Public Instance > IoT Platform > Devices > Device Details

BL10x-miyao Online

Product: BL10x-電明 ProductKey: [Copy] DeviceSecret: [View]

Device Information Topic List TSL Data Device Shadow Manage Files Device Log Online Debug Groups Task

Status Events Invoke Service

Enter a module name Enter a property name or identifier

Property Identifier	Property Name	Data Type	Update Time	Updated Value	Expected Value	Actions
D0	D0	int	Jun 29, 2021, 09:13:29.390	24	-	View Data
D1	D1	int	Jun 29, 2021, 09:13:29.390	0	-	View Data
D2	D2	int	Jun 29, 2021, 09:13:29.390	0	-	View Data
D3	D3	int	Jun 29, 2021, 09:13:29.390	0	-	View Data
D4	D4	int	Jun 29, 2021, 09:13:29.390	0	-	View Data
D5	D5	int	Jun 29, 2021, 09:13:29.390	0	-	View Data
D6	D6	int	Jun 29, 2021, 09:13:29.390	0	-	View Data
D7	D7	int	Jun 29, 2021, 09:13:29.390	85	-	View Data
Q0	Q0	bool	Jun 29, 2021, 09:13:29.390	1 (开)	-	View Data
Q1	Q1	bool	Jun 29, 2021, 09:13:29.390	0 (关)	-	View Data

Alibaba Cloud > Wotbench > China (Shanghai)

Public Instance > IoT Platform > Devices > Device Details

Q5	Q5	bool	Jun 29, 2021, 09:19:02.918	0 (关)	-	View Data
Q6	Q6	bool	Jun 29, 2021, 09:19:02.918	0 (关)	-	View Data
Q7	Q7	bool	Jun 29, 2021, 09:19:02.918	0 (关)	-	View Data
VW0	VW0	int	Jun 29, 2021, 09:19:02.918	8	-	View Data
VW2	VW2	int	Jun 29, 2021, 09:19:02.918	0	-	View Data
VW4	VW4	int	Jun 29, 2021, 09:19:02.918	0	-	View Data
VW6	VW6	int	Jun 29, 2021, 09:19:02.918	0	-	View Data
VW8	VW8	int	Jun 29, 2021, 09:19:02.918	0	-	View Data
Y0	Y0	bool	Jun 29, 2021, 09:19:02.918	1 (开)	-	View Data
Y1	Y1	bool	Jun 29, 2021, 09:19:02.918	0 (关)	-	View Data
Y2	Y2	bool	Jun 29, 2021, 09:19:02.918	0 (关)	-	View Data
Y3	Y3	bool	Jun 29, 2021, 09:19:02.918	0 (关)	-	View Data
Y4	Y4	bool	Jun 29, 2021, 09:19:02.918	0 (关)	-	View Data
Y5	Y5	bool	Jun 29, 2021, 09:19:02.918	0 (关)	-	View Data
Y6	Y6	bool	Jun 29, 2021, 09:19:02.918	0 (关)	-	View Data
Y7	Y7	bool	Jun 29, 2021, 09:19:02.918	1 (开)	-	View Data

Sending command from Alibaba Cloud

Note: Currently Alibaba shadow function is not supported. Need to send command from online

debugging

5.4.5 HUAWEI Cloud Configuration

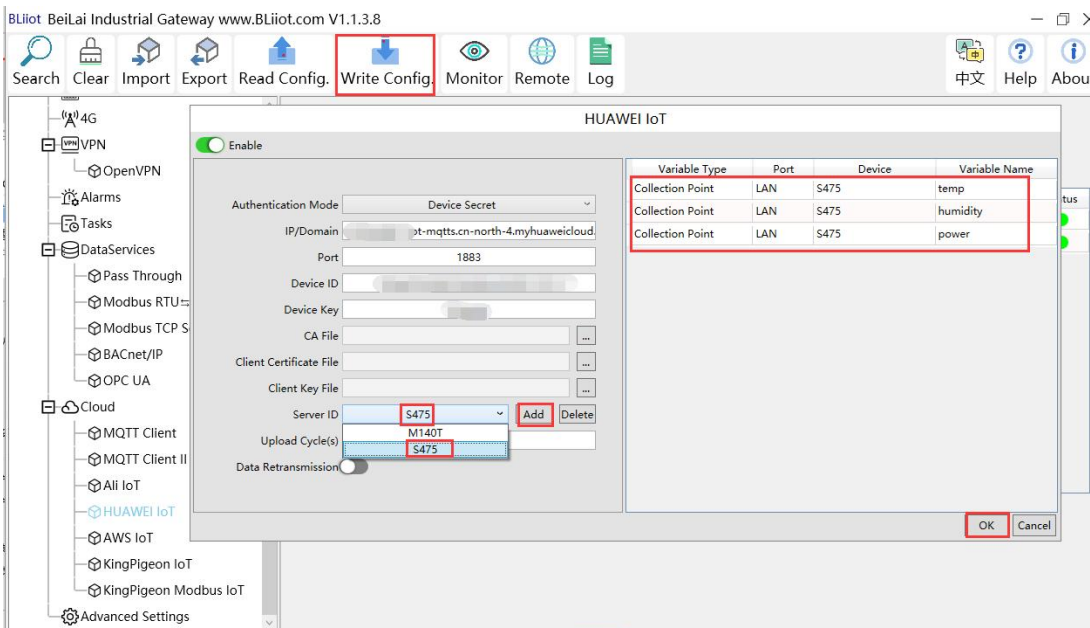
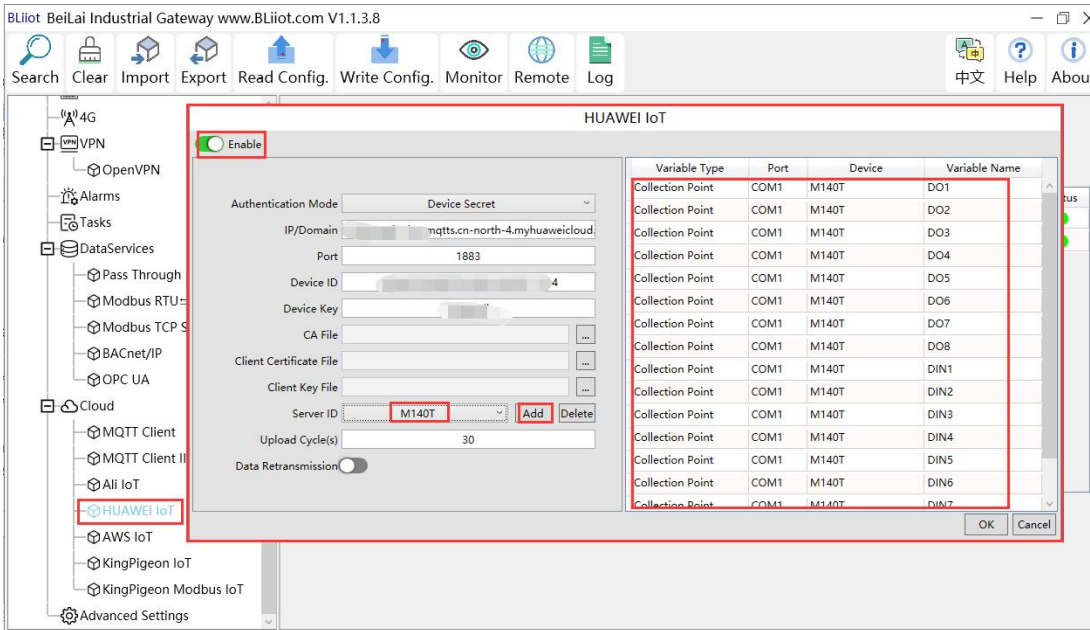

- (1) Double-click "HUAWEI CLOUD IoT" to enter configuration box.
- (2) Click the Enable button to enable HUAWEI CLOUD. Default: off. Gray: Disabled, Green: Enabled.
- (3) Authentication mode: Choose whether to use a key connection or a certificate connection. Default is key connection.
- (4) IP/domain: Connect to the address of HUAWEI CLOUD, enter the console, click Overview, and the platform access address of the device access service console, you can view the server address.
- (5) Port: 1883 by default, 1883 for key connection, and 8883 for certificate connection.
- (6) Device ID: Set the same as the device ID on HUAWEI CLOUD.
- (7) Device key: Set the same key as the key on HUAWEI CLOUD, and enter the key when creating a device.
- (8) CA file: When enabling certificate connection, select the root certificate file to upload.
- (9) Client certificate file: When enabling certificate connection, select the client certificate file to upload.
- (10) Client key file: When enabling certificate

connection, select the client key file upload. (11) Server ID: Set the same as the service ID on HUAWEI CLOUD, the service ID set when creating the product. One service ID or multiple service IDs can be set. This example introduces multiple service ID applications, adding "M140T" and "S475" service IDs. (12) Upload cycle: The interval for regular data release, the default is 30S. (13) Data retransmission: whether to enable data retransmission, click the button to enable. Gray: disabled, Green: enabled. (14) Select data point upload: select the data point to be uploaded in the box to the right of the configuration box, the default is blank means all upload. In this example, the service ID "M140T" selects the data point of M140T to upload, the service ID item selects "M140T", right-clicks the mouse in the right box, the data point box pops up, and selects the data point of "M140T", for example: click the data point of M140T DO1, click and hold the left mouse button, move the mouse down to the data point to be uploaded, click "OK", and the data point you selected will be displayed in the box. Select the service ID "S475", right-click in the box, the data point box will pop up, select the data point, and click "OK".

(15) Click "OK" to confirm the configuration of HUAWEI CLOUD. (16) Click "Write Configuration", HUAWEI CLOUD will be enabled after the gateway device restarts. Re-open the configuration software to log in to the device. On the basic information page, you can see that the "HUAWEI CLOUD online status" indicator light is green, indicating that HUAWEI CLOUD is connected. The rightmost shows the online status of the slave device.

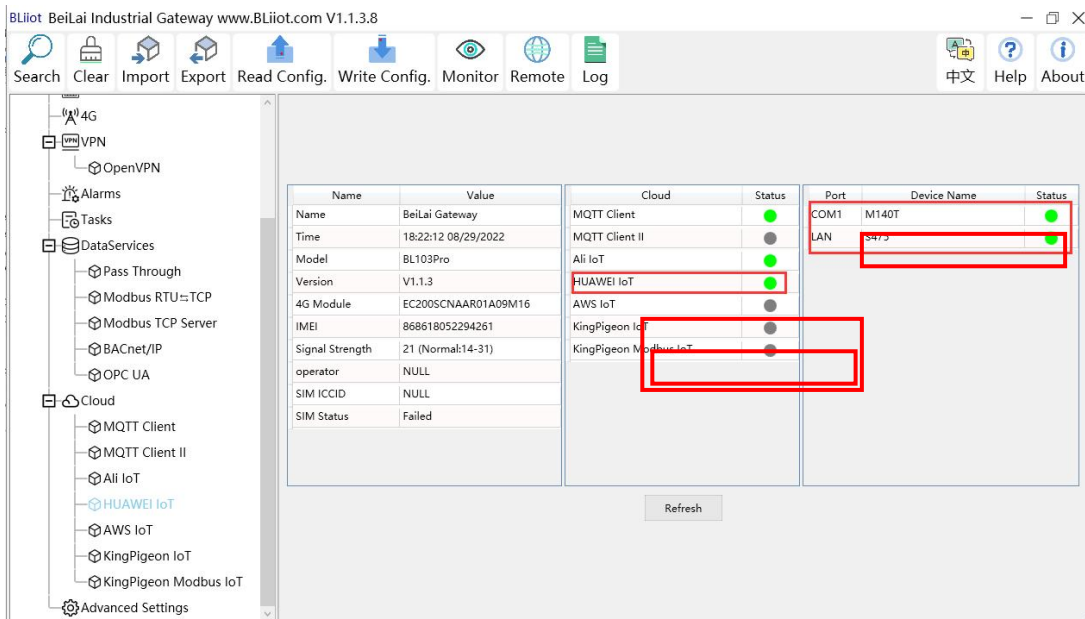

5.4.5.1 View and Send Command in HUAWEI Cloud

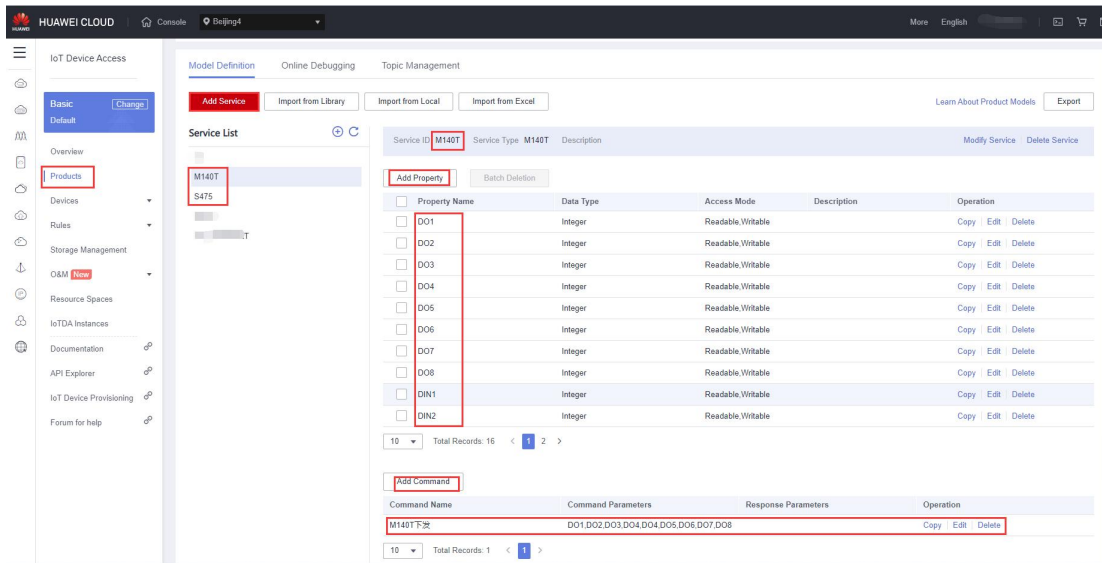

The property name is the variable label identifier on the configuration software

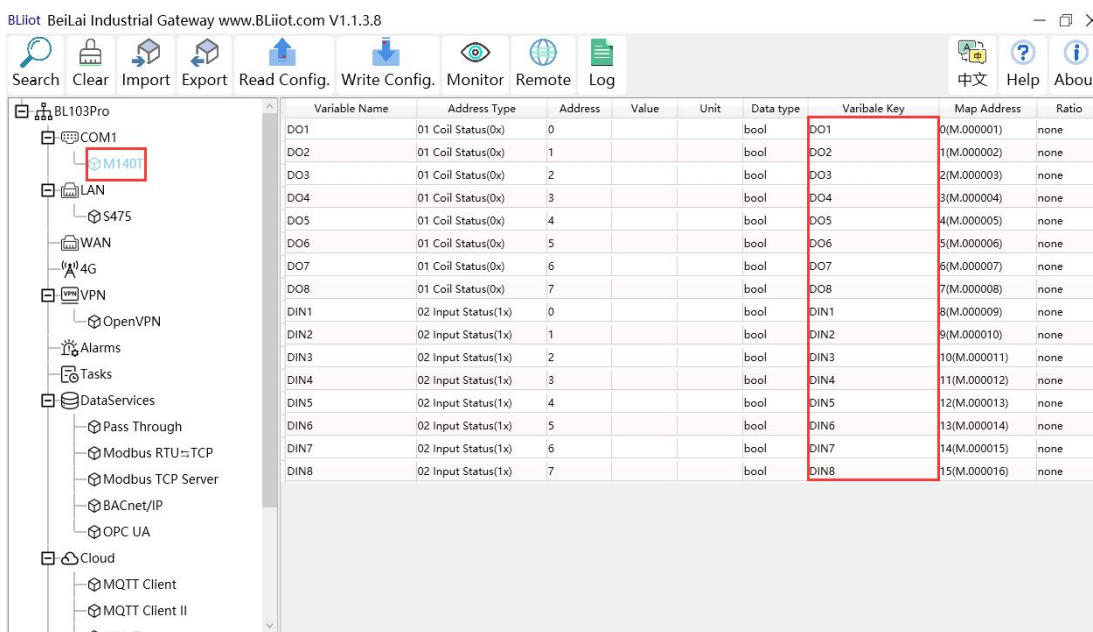

Data received in HUAWEI Cloud:

BL10x Online Product

Resource: BLXXX Device ID: [redacted]

Space: [redacted]

Node ID: [redacted]

Registered: Jan 22, 2021 12:06:20 GMT+08:00

Firmware: V1.0.3

Version: [redacted]

Description: [redacted]

Authentication: Secret Reset Secret

Type: [redacted]

Node Type: Directly connected

Software: v1.0

Version: [redacted]

Latest Data Reported Query Historical Data View All Properties

DO1	DO2	DO3	DO4	DO5
"0"	"1"	"1"	"1"	"1"
<M140T>	<M140T>	<M140T>	<M140T>	<M140T>
Aug 29, 2022 18:32:00 GMT+08:00	Aug 29, 2022 18:32:00 GMT+08:00	Aug 29, 2022 18:32:00 GMT+08:00	Aug 29, 2022 18:32:00 GMT+08:00	Aug 29, 2022 18:32:00 GMT+08:00

IM140T	DO1	Read-only, Writable	0
	DO2	Read-only, Writable	1
	DO3	Read-only, Writable	1
	DO4	Read-only, Writable	1
	DO5	Read-only, Writable	1
	DO6	Read-only, Writable	0
	DO7	Read-only, Writable	1
	DO8	Read-only, Writable	0
	DIN1	Read-only, Writable	1
	DIN2	Read-only, Writable	1
	DIN3	Read-only, Writable	1
	DIN4	Read-only, Writable	1
	DIN5	Read-only, Writable	1
	DIN6	Read-only, Writable	1
	DIN7	Read-only, Writable	1
	DIN8	Read-only, Writable	1
S475	temp	Read-only	2790
	humidity	Read-only	6410
	power	Read-only	1420

Send command from HUAWEI Cloud

Add command to be sent

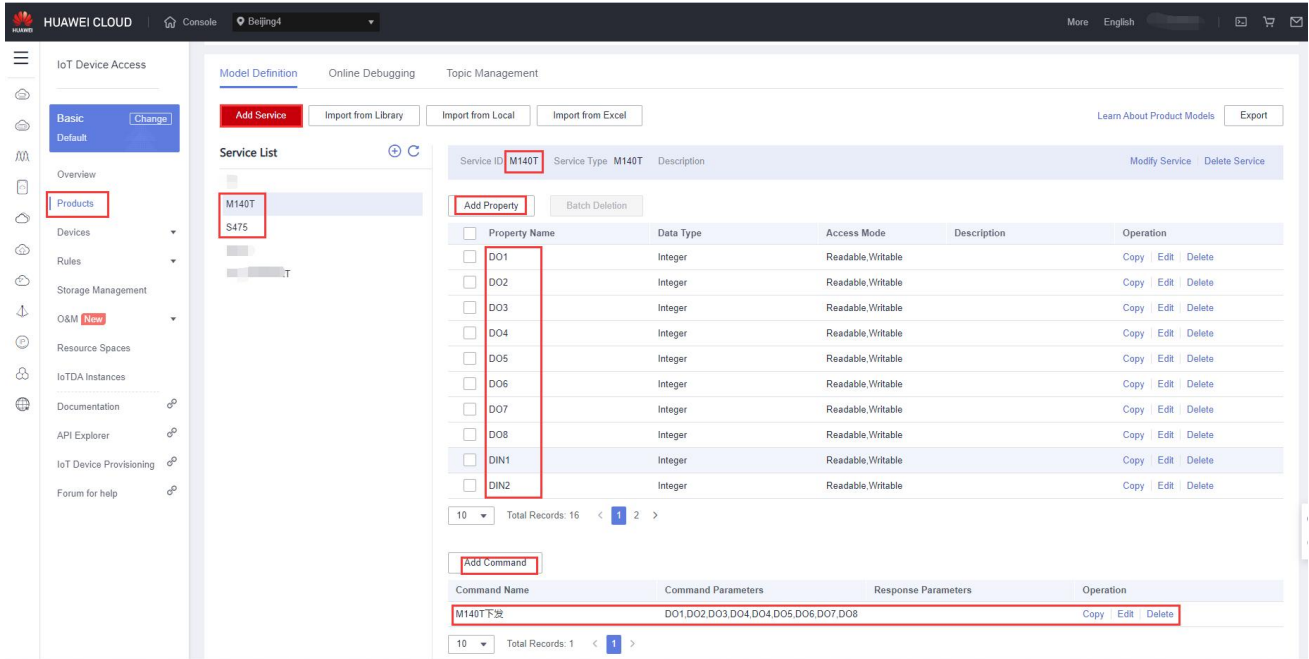

Command to send data

Take the DO2 of M140T as an example

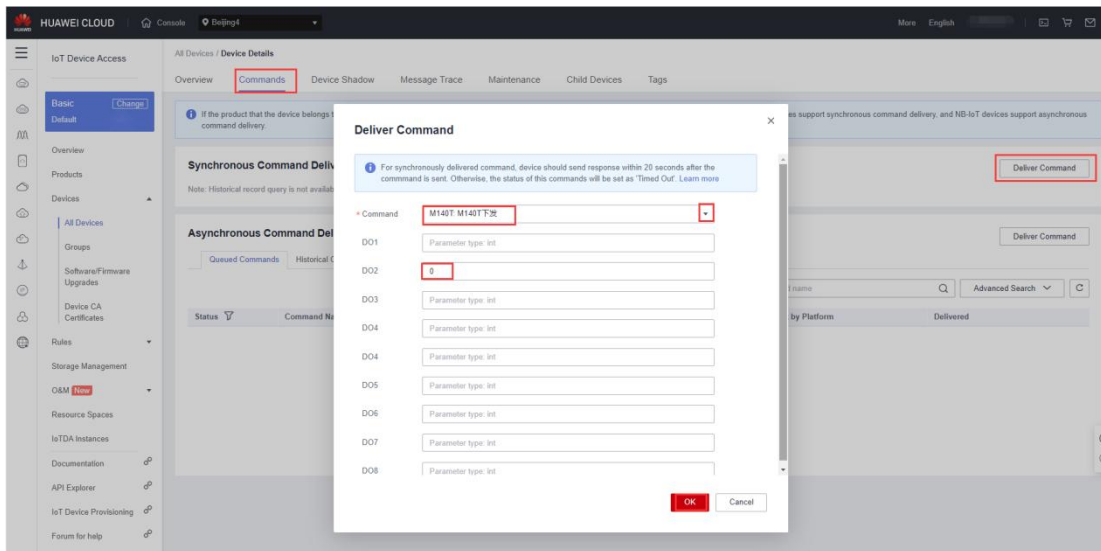

Check whether the DO2 data has changed in the device shadow, from the original "1" to "0".

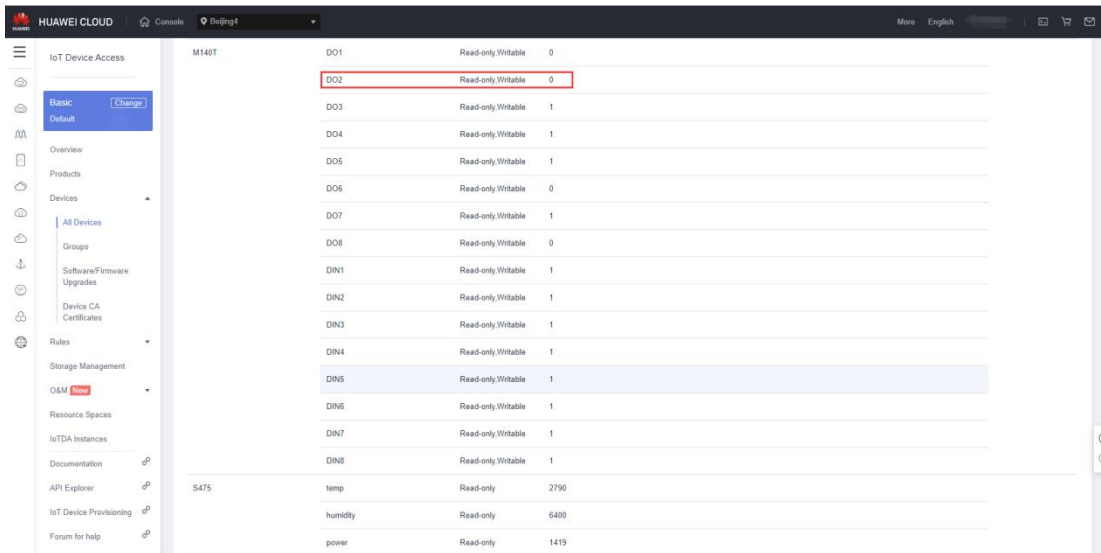

5.4.6 AWS Cloud Configuration

AWS supports publishing multiple topics. Configuration is the same as that of configuring multiple service ID of HUAWEI Cloud. Below example is configuring single topic with all datapoints to be published.

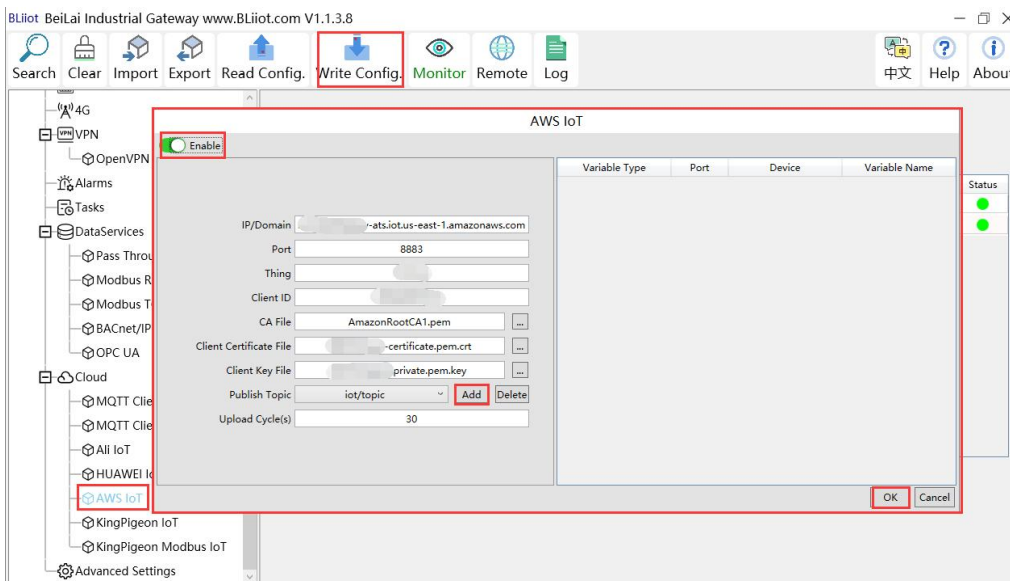

(1) Double-click "Amazon IoT" to enter configuration box. (2) Click the Enable button to enable Amazon Cloud. Default: off. Gray: disabled Green: enabled. (3) IP/domain: Fill in the terminal node, enter the console, and click "Interaction" of "Thing" to view. (4) Port: 8883. (5) Thing: Fill in the ARN, and click "Details" of "Thing" to view the ARN. (6) Client ID: fill in the account ID and view it in the user information. (7) CA file: Select the root certificate file to upload. (8) Client certificate file: Select the client certificate file to upload. (9) Client key file: Select the client key file to upload. (10) Publish topic: the topic created when creating the rule, the topic name used by MQTT to publish the message, click "Add" to fill in the publishing topic name. You can fill in multiple publishing topics, select a publishing topic, and click "Delete" to delete the selected topic. For example: the topic viewed in the

"rule" of "action" is "iot/topic", so fill in "iot/topic".

Rule query statement

The source of the messages you want to process with this rule.

```
SELECT * FROM 'iot/topic'
```

(11) Upload cycle: The interval for regular data release, the default is 30S. (12) Select data point upload: select the data point to be uploaded in the box on the right side of the configuration box, the default is blank means all upload. (13) Click "OK" to confirm the configuration of Amazon Cloud. (14) Click "Write Configuration", and Amazon Cloud will be enabled after the gateway device restarts. Re-open the configuration software to log in to the device, and on the basic information page, you can see that the "Amazon Cloud Online Status" indicator light is green, indicating that the Amazon cloud is connected. The rightmost shows the online status of the slave device.

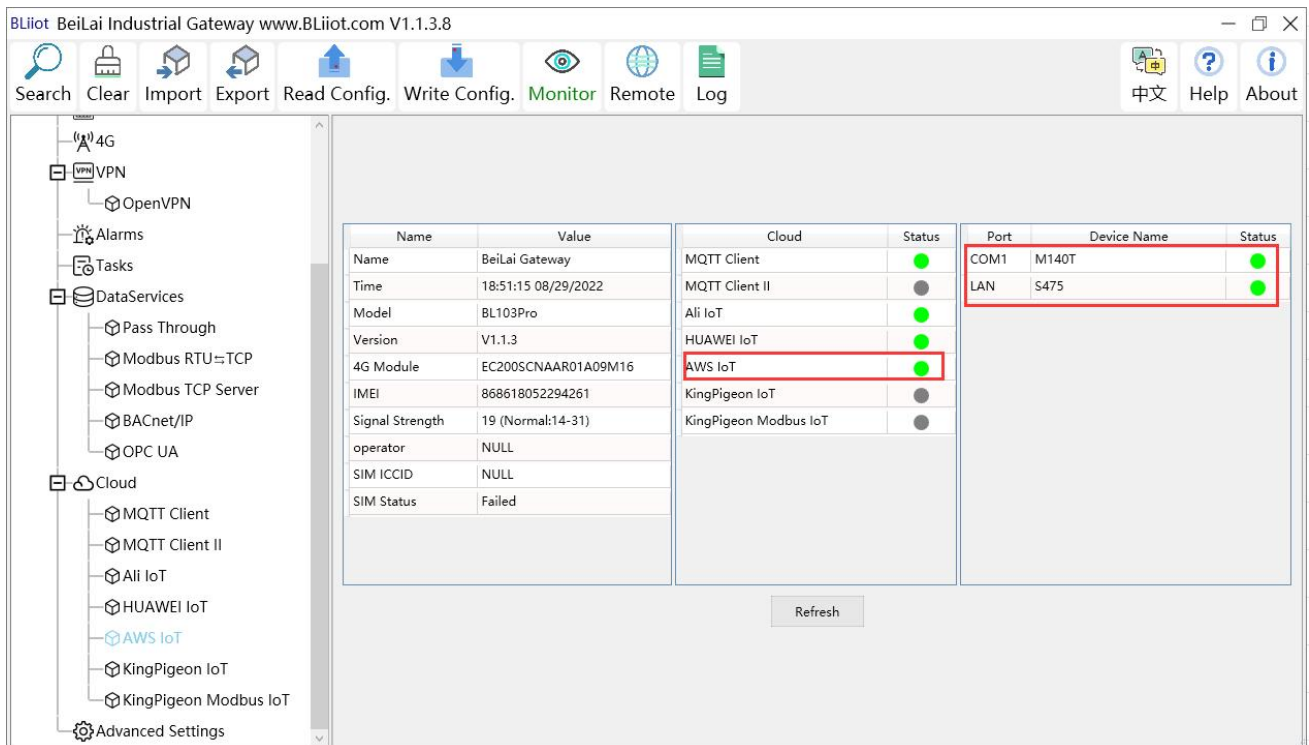

5.4.6.1 View and Send Command in AWS Cloud

Login to AWS, click Act, click Test and select subscription topic "iot/topic" to view messages published by BL102 gateway

Subscriptions

Subscribe to a topic

Publish to a topic

Subscription topic: Subscribe to topic

Max message capture:

Quality of Service:
 0 - This client will not acknowledge to the Device Gateway that messages are received
 1 - This client will acknowledge to the Device Gateway that messages are received

MQTT payload display:
 Auto-format JSON payloads (improves readability)
 Display payloads as strings (more accurate)

Subscriptions

Subscribe to a topic

Publish to a topic

iot/topic

Publish: Specify a topic and a message to publish with a QoS of 0.

iot/topic Publish to topic

```

1  {
2  "message": "Hello from AWS IoT console"
3  }

```

iot/topic June 29, 2021, 10:53:30 (UTC+0800) Export Hide

```

{
  "time": "02:53:30 06/29/2021 UTC 0.0.0",
  "lat": "0.0000",
  "lng": "0.0000",
  "V0": 1,
  "V1": 0,
  "V2": 0,
  "V3": 0,
  "V4": 0,
  "V5": 0,
  "V6": 0,
  "V7": 1
}

```

Subscriptions

Subscribe to a topic

Publish to a topic

iot/topic

Publish: Specify a topic and a message to publish with a QoS of 0.

iot/topic Publish to topic

```

1  {
2  "message": "Hello from AWS IoT console"
3  }

```

```

{"V3": 0,
"V4": 0,
"V5": 0,
"V6": 0,
"V7": 0,
"V0": 8,
"V2": 0,
"V4": 0,
"V6": 0,
"V8": 0
}

```

iot/topic June 29, 2021, 10:54:03 (UTC+0800) Export Hide

5.4.7 King Pigeon Cloud via Modbus

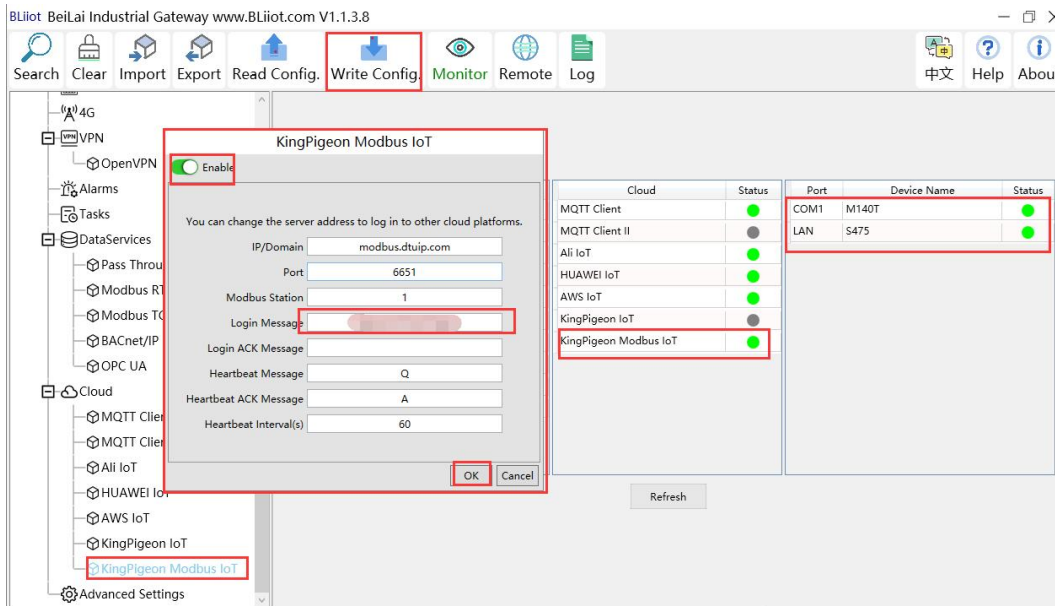

- (1) Double click KingPigeon Modbus IoT to enter configuration window
- (2) Click Enable to enable(green) King Pigeon cloud via Modbus. Default is disabled (Gray)
- (3) Server IP/Domain Name: modbus.dtuip.com. (Automatic filling in default)
- (4) Server Port: 6651 (Automatic filling in default)
- (5) Modbus Station: Set Gateway BL102 Modbus communication address
- (6) Login Message: Input device serial number issued by King Pigeon.
- (7) Login ACK Message: Not necessary for King Pigeon cloud connection
- (8) Heartbeat Message: Q (Automatic filling in default)
- (9) Heartbeat ACK Message: A(Automatic filling in default)
- (10) Heartbeat Interval: Set cycle time of sending Heartbeat message. Default is 60s
- (11) Click OK to confirm the configuration.
- (12) Click Write Configuration. Gateway will restart and King Pigeon Cloud via Modbus is enabled successfully. Open configuration software and login device. King Pigeon cloud via Modbus connection status can be viewed from basic information. Green indicates device is connected King Pigeon cloud via Modbus. Slave devices connection status can be viewed from the right box.

5.4.7.1 View Data in King Pigeon Cloud via Modbus

Configure datapoint in cloud like below picture. First create datapoint, then enter connection setting and put datapoint Modbus ID, function code, address, data format, byte sequence and collecting cycle. Modbus address in King Pigeon cloud and configuration software is deviated by 1. For example, datapoint VW0 of PLC S7-200SMART in configuration software is 8, then put 9 in cloud.

Sensor names in cloud can be different from those in configuration software

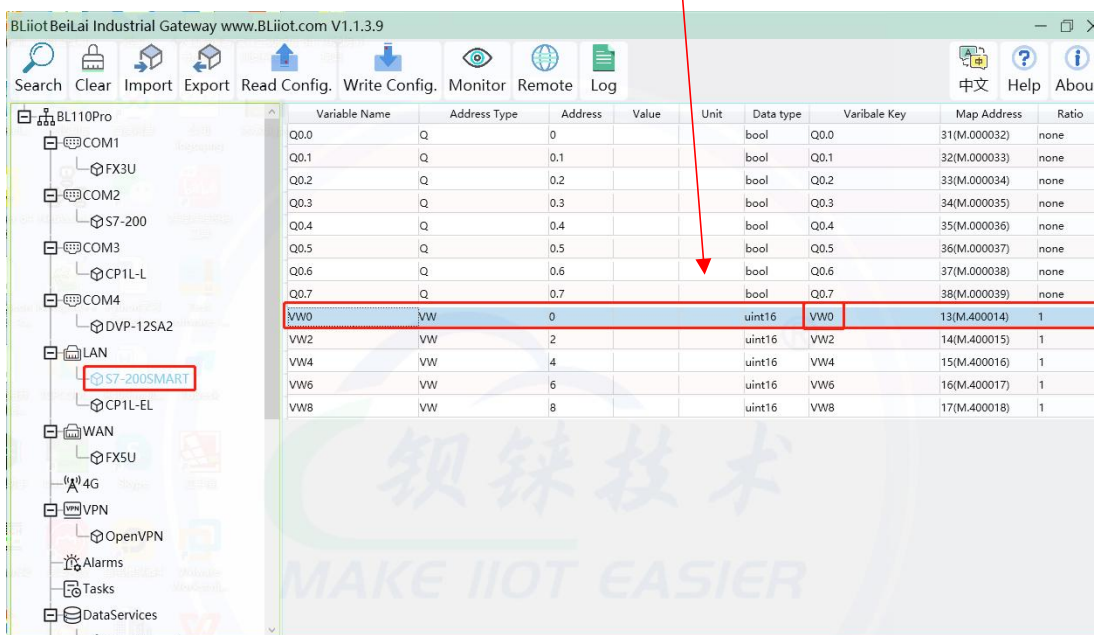
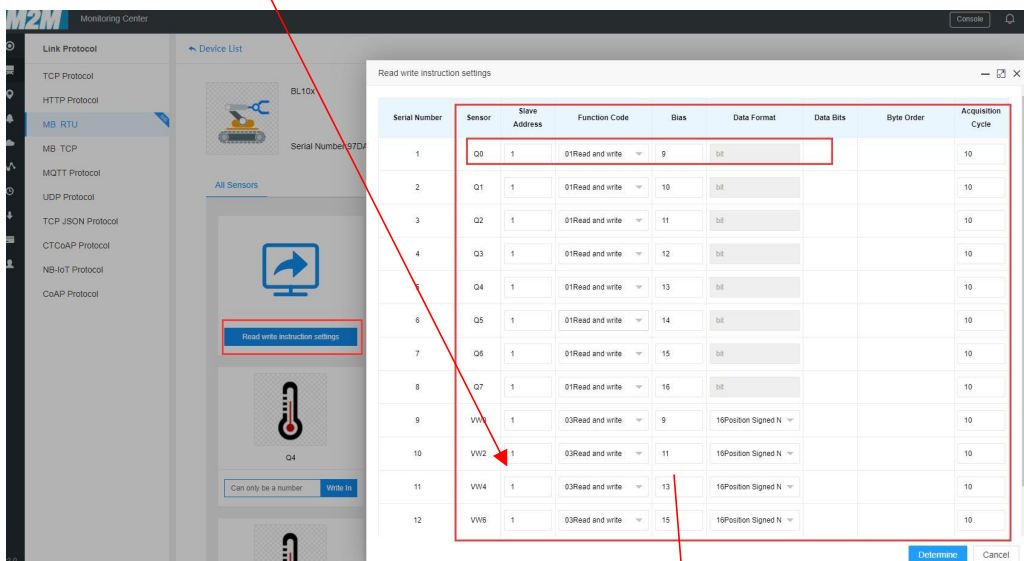
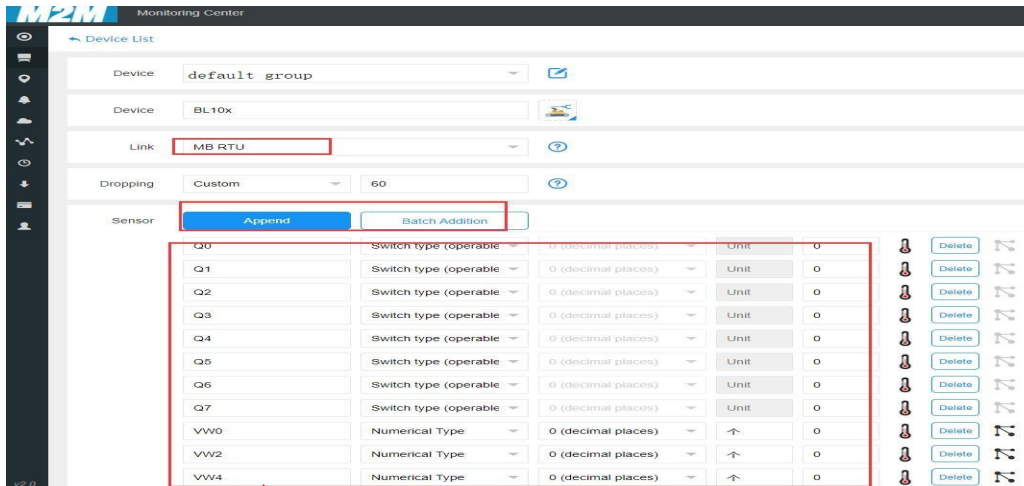

Data collected is like below picture

ID	Status	Value
Y0	ON	
Y1	OFF	
Y2	OFF	
Y3	OFF	
Y4	OFF	
Y5	OFF	
Y6	OFF	
Y7	ON	
D0		24.0000 ↑
D1		0.0000 ↓

ID	Status	Value
D2		0.0000 ↑
D3		0.0000 ↑
D4		0.0000 ↑
D5		0.0000 ↑
D6		0.0000 ↑
D7		85.0000 ↓
Q0	ON	
Q1	OFF	
Q2	OFF	
Q3	OFF	

ID	Status	Value
Q4	OFF	
Q5	OFF	
Q6	OFF	
Q7	OFF	
VWS0		8.0000 ↑
VWS2		0.0000 ↑
VWS4		0.0000 ↑
VWS6		0.0000 ↑
VWS8		0.0000 ↑

Send command from cloud

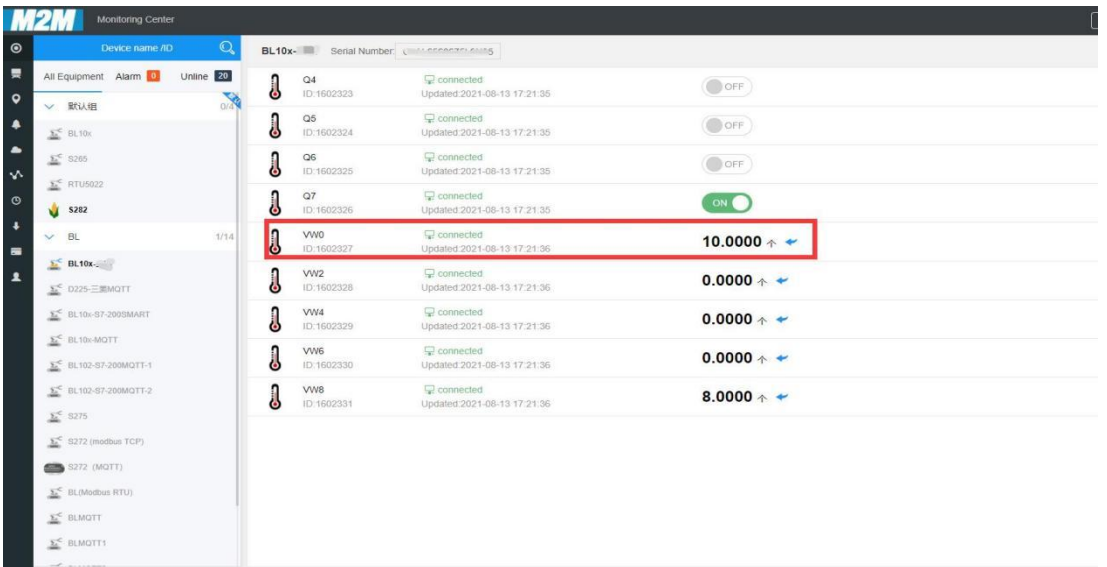
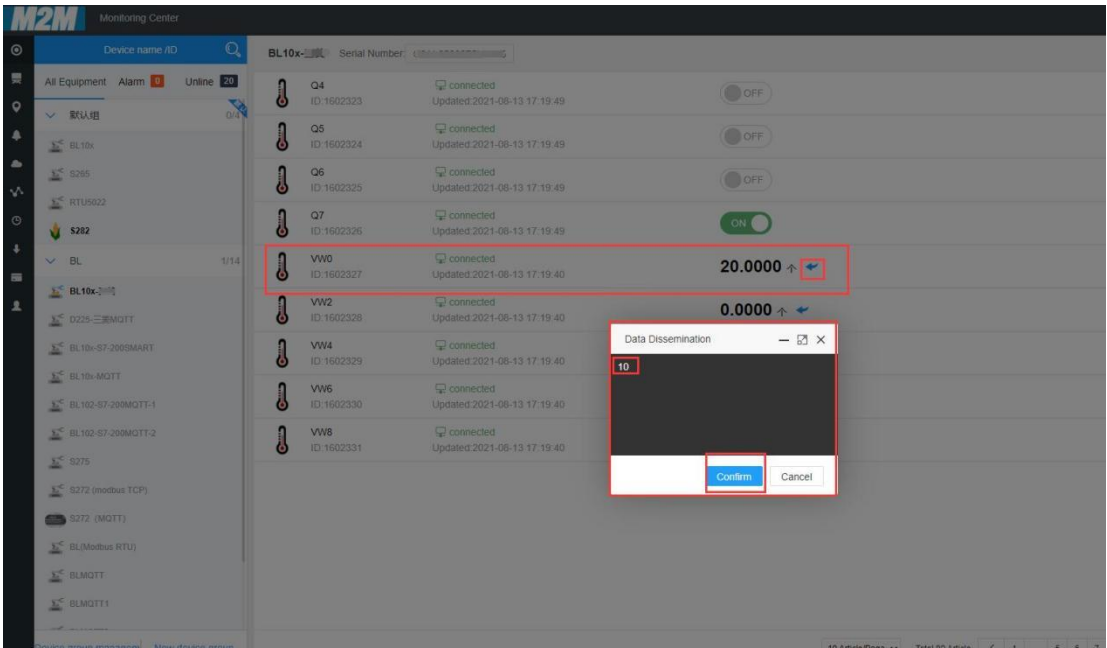

5.4.8 King Pigeon Cloud via MQTT

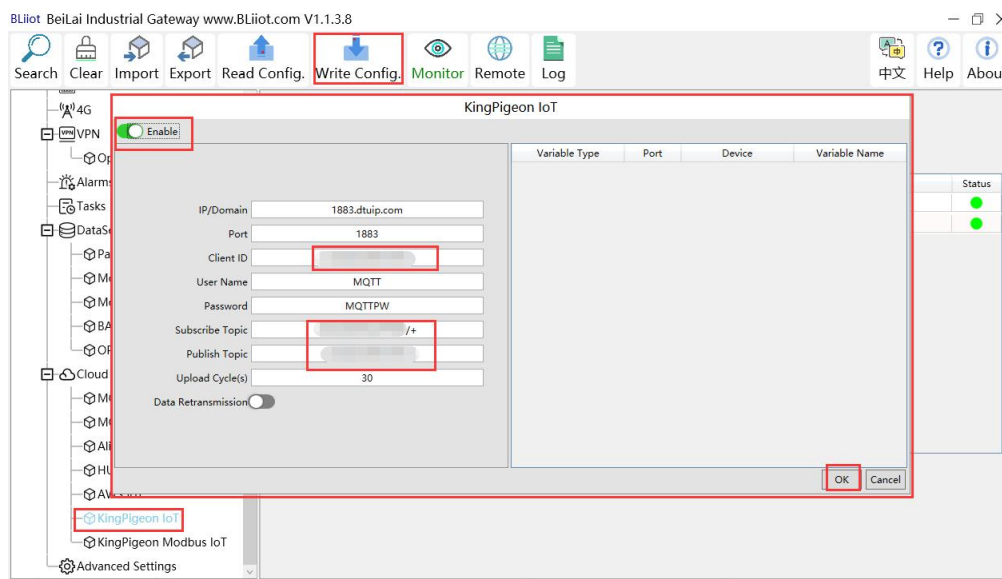

- (1) Double click King Pigeon IoT to enter configuration box
- (2) Click Enable to enable(green) King Pigeon cloud connection via MQTT. Default is disabled(gray)
- (3) Server IP/Domain Name: 1883.dtuip.com(Automatic filling in default)
- (4) Server Port: 1883 (Automatic filling in default)
- (5) Client ID: Input device serial number issued by King Pigeon
- (6) User Name: MQTT (Automatic filling in default)
- (7) Password: MQTTPW(Automatic filling in default)
- (8) Subscribe Topic: Input device serial number/+ issued by King Pigeon
- (9) Publish Topic: Input device serial number issued by King Pigeon.
- (10) Automatic Data Upload Cycle: Cycle time of uploading data. In default it's 30s
- (11) MQTT Data Retransmission: Click it to enable(green) offline data retransmission once network resumes.
- (12) Datapoint Uploading Selection: Select the datapoint to upload in the right box. In default it's blank with all datapoints to be uploaded
- (13) Click OK to confirm King Pigeon Cloud via MQTT configuration
- (14) Click Save Data. Gateway will restart and King Pigeon Cloud via MQTT is configured successfully. Open configuration software and login the device. King Pigeon Cloud connection status via MQTT can be viewed from basic information. Green indicates King Pigeon cloud via MQTT is connected. Slave device connection status can be viewed from the right box.

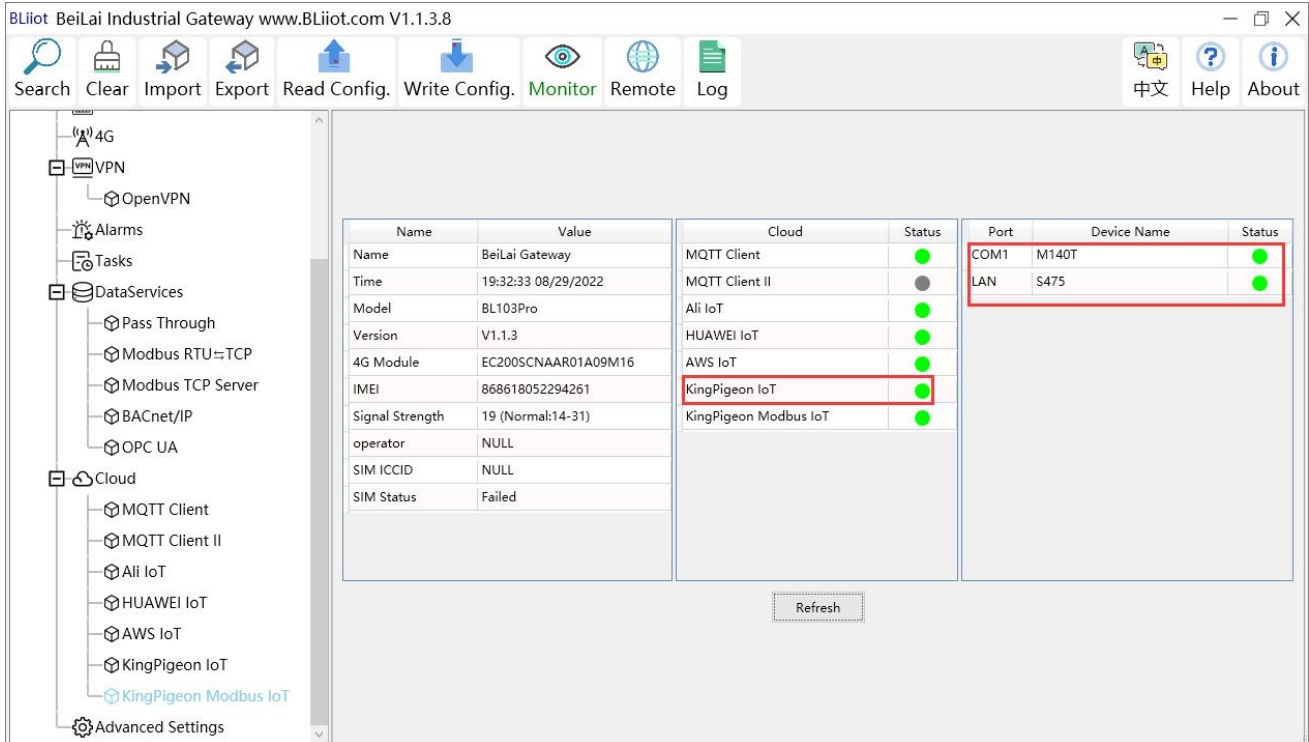

5.4.8.1 View Data in King Pigeon Cloud via MQTT

Create datapoint in cloud first. Set datapoint mark is the same as MQTT flag in configuration software. Below is example of some datapoint configuration. For example, MQTT flag of datapoint VW0 in configuration software is VW0, then set read-write mark VW0 in King Pigeon cloud

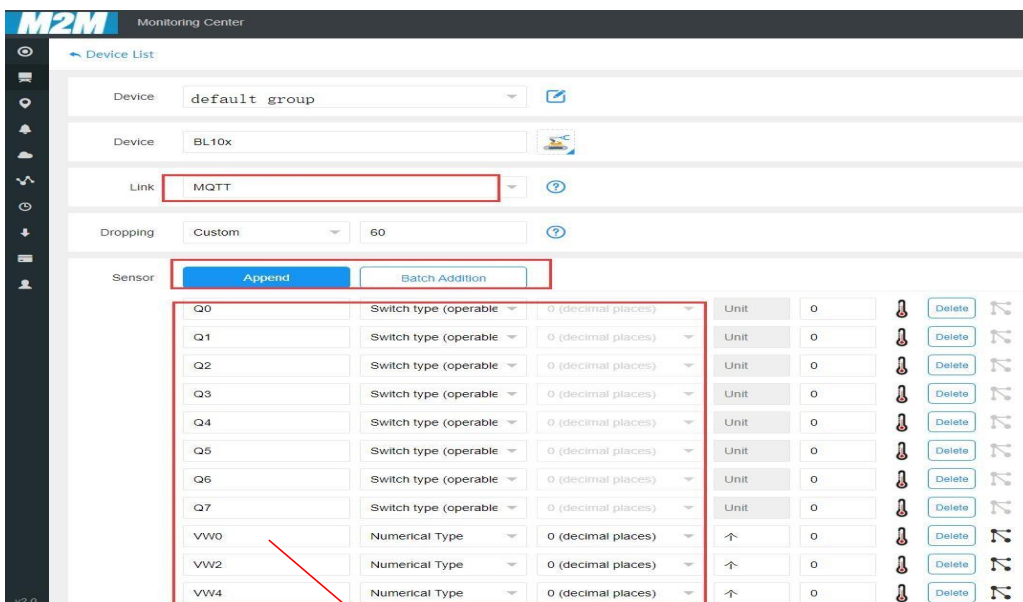

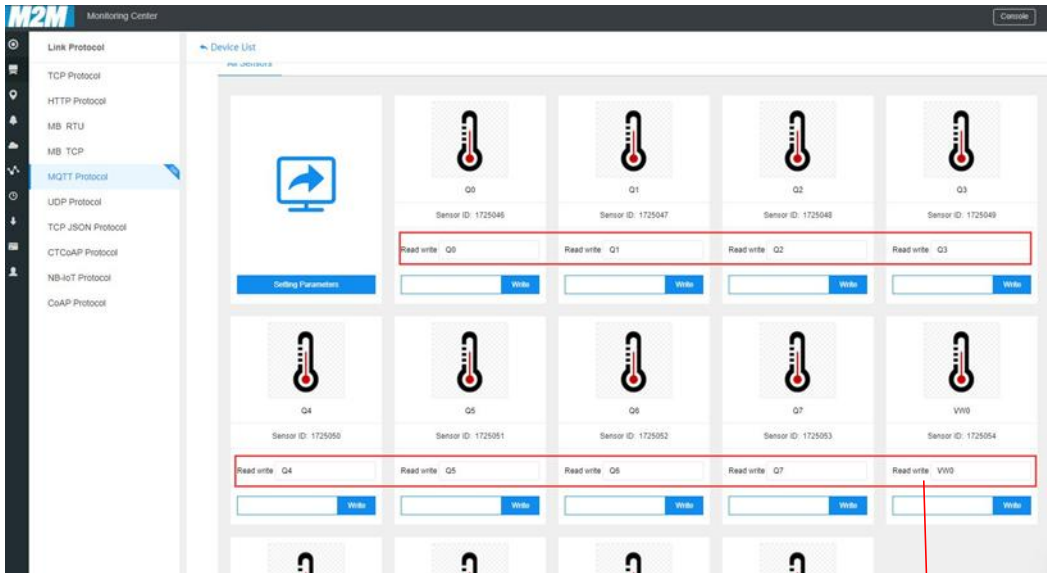

BLIiot BeiLai Industrial Gateway www.BLIiot.com V1.1.3.9

Search Clear Import Export Read Config. Write Config. Monitor Remote Log 中文 Help About

Variable Name	Address Type	Address	Value	Unit	Data type	Variable Key	Map Address	Ratio
Q0.0	Q	0			bool	Q0.0	31(M.000032)	none
Q0.1	Q	0.1			bool	Q0.1	32(M.000033)	none
Q0.2	Q	0.2			bool	Q0.2	33(M.000034)	none
Q0.3	Q	0.3			bool	Q0.3	34(M.000035)	none
Q0.4	Q	0.4			bool	Q0.4	35(M.000036)	none
Q0.5	Q	0.5			bool	Q0.5	36(M.000037)	none
Q0.6	Q	0.6			bool	Q0.6	37(M.000038)	none
Q0.7	Q	0.7			bool	Q0.7	38(M.000039)	none
VW0	VW	0			uint16	VW0	13(M.400014)	1
VW2	VW	2			uint16	VW2	14(M.400015)	1
VW4	VW	4			uint16	VW4	15(M.400016)	1
VW6	VW	6			uint16	VW6	16(M.400017)	1
VW8	VW	8			uint16	VW8	17(M.400018)	1

Data collected is as below picture:

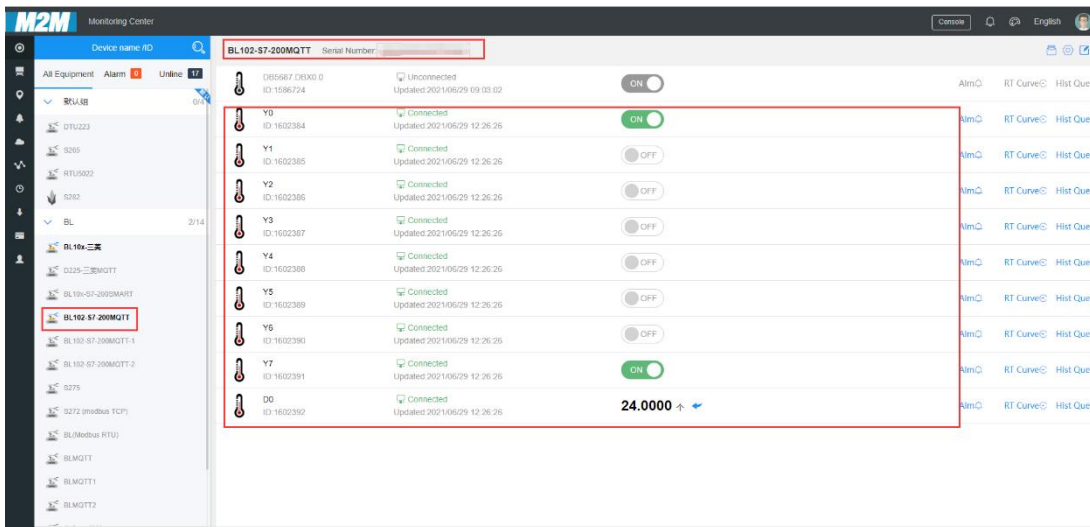

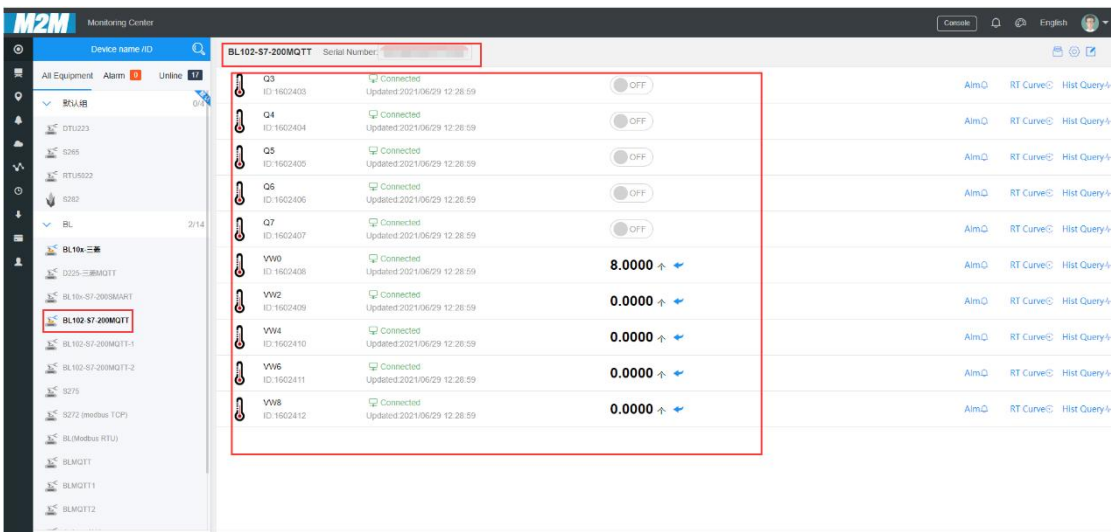
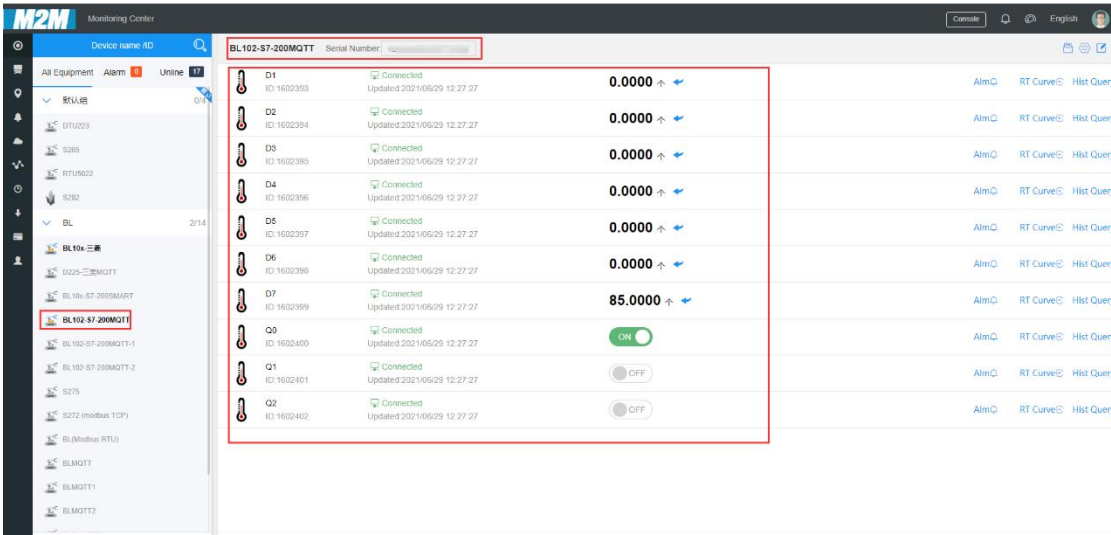

Send command from cloud, below is example of controlling FX3U datapoint Y6

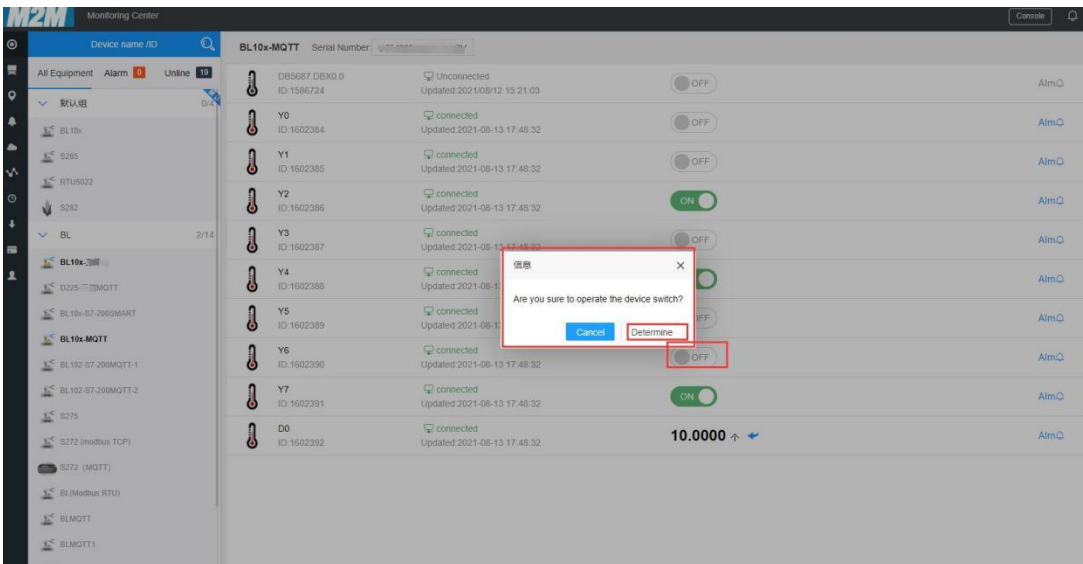

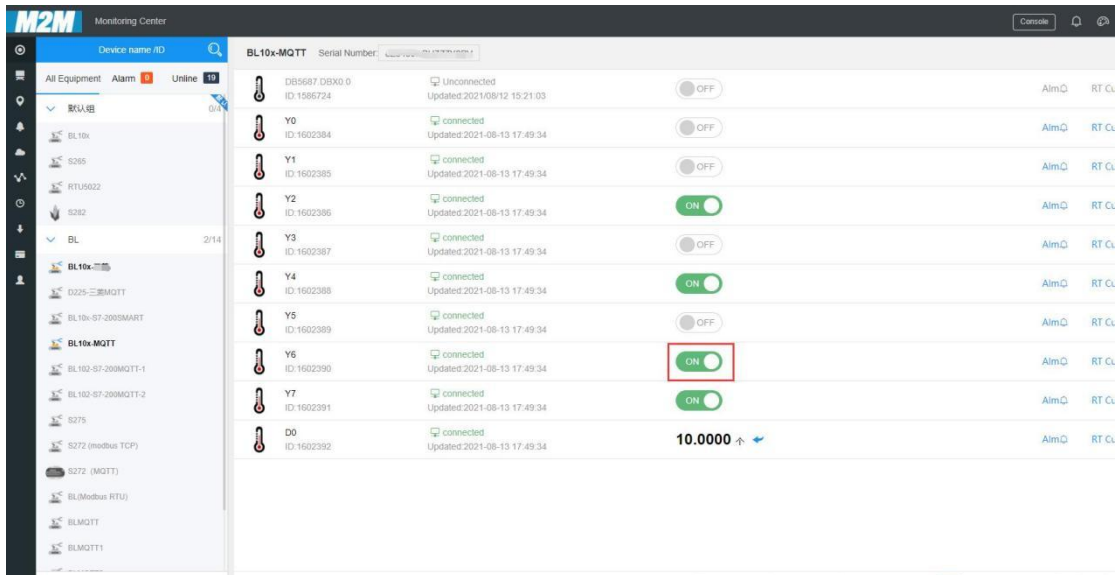

5.4.9 King Pigeon Cloud MQTT Data Format

The "KingPigeon" JSON data format of MQTT Client and MQTT Client II is the same as that of King Pigeon MQTT. The details are as follows

(1) Valid Load Data Format in device Publishing messages

Publish Topic: Serial Number (Configured publish topic)

```
{
  "sensorDatas": [
    {
      //Boolean value
      "flag": "REG001", //Read-write identification mark
      "switcher": 0 //Data Type and Value
    },
    {
      //Numeric Type
      "flag": "REG005", //Read-Write identification mark
      "value": 3 //Data Type and Value
    },
    {
      //4G Module signal value
      "flag": " signal_strength ", //Read and write identifiers, fixed and cannot
      be modified
      "value": 28 //data type and value
    }
  ],
}
```

"state": "alarm", //Alarm mark(Set Alarm Event in configuration software. Once alarm is trigger, this mark will appear. It's not included in scheduled automatically uploaded data)

"state": "recovery", //Alarm recovery mark (Only appear when there's alarm recovery. It's not included in scheduled automatically uploaded data)

"gateway_identify": "Beilai" //Gateway name identifier, upload gateway name

"time": "1622700769", //Time mark, it's time stamp of data uploading

"addTime": "2021-06-03 06:12:49" //Time mark, it's time of device data uploading

"retransmit": "enable" //Retransmission mark, MQTT historical data (Only appear when there's historical data retransmission. It's not included in scheduled automatically uploaded data)

}

Note:

//Read-Write Mark: character is "flag", followed by "Datapoint MQTT flag", it's the MQTT mark set in configuration software when adding datapoint. It can be customized

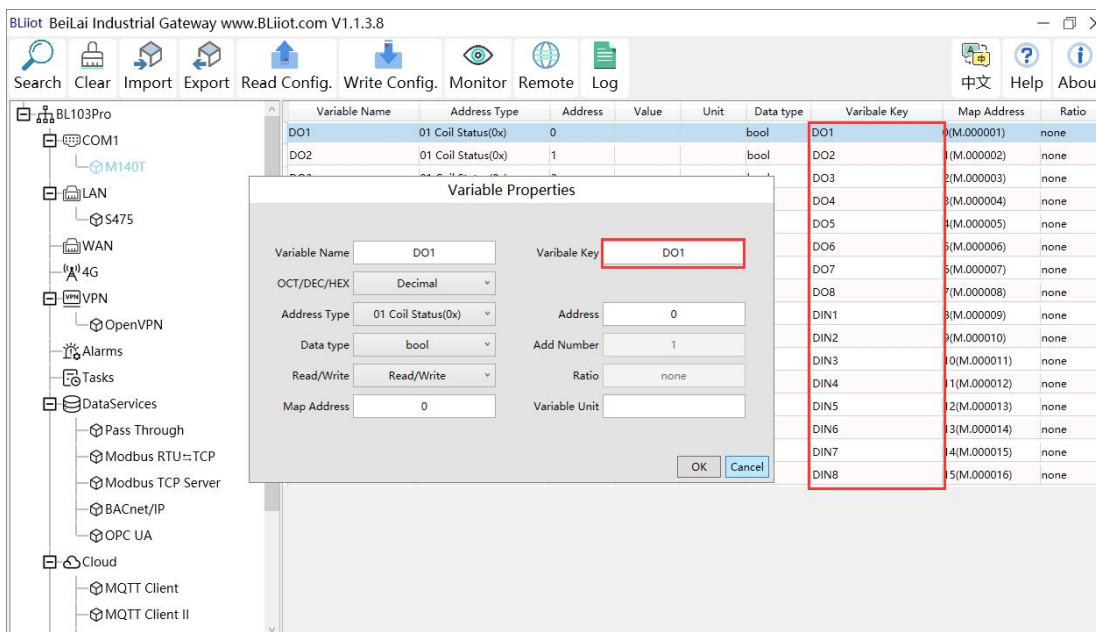

//Data Type and Value:

1) Boolean data: character is "switcher", followed by "0" or "1"(0 represents open, 1 represents close)

2) Numeric Data: character is "value", followed by actual value

//Alarm, Recover mark, character is "state", followed by "alarm" or "recovery"(alarm represents alarm data, recovery represents alarm recovery data)

//Gateway name identification: the character is "gateway_identify", followed by "gateway name".

//Time mark: character is "time", followed by actually data uploading timestamp

//Time mark, character is "addtime", followed by "gateway time"

//Retransmission mark: character is "retransmit", followed by "enable"

Offline collected data will be temporarily saved in gateway device. Once network resumes, the data will be re-transmitted. Use "retransmit" mark for historical data (MQTT Data Retransmission must be enabled in configuration software)

(2) Valid Load Data Format in device Subscribing messages

Subscribe Topic: Serial Number/+ (Subscribe topic set in configuration software)
(King Pigeon cloud message publishing topic is "serial number/sensor ID", thus wildcard "/" must be added for device Subscribing Topic so that cloud can publishing data for controlling)

```
{
  "sensorDatas":
  [
    {
      "sensorId": 211267, // cloud sensor ID
      "switcher":1, //Data Type and Value
      "flag":"REG001" //Read-Write Mark
    }
    {
      //Send Numerical
      "sensorId": 160239, //Platform Sensor ID
      "value":"10", //data type and value
      "flag":"REG001" //Read and write identification
    }
  ],
  "down":"down" //Cloud downlink message mark
}
```

Note:

//cloud sensor ID: character is "sensorID", followed by ID (automatically generated by cloud.
Not necessary if it's self-built cloud)

//Data Type and Value:

1) Boolean Data: character is "switcher", followed by "0" or "1"

(0 represents open, 1 represents close)

2) Numeric Data: character is "value", followed by "actual value"

//Read-Write Mark: character is "flag", followed by "datapoint MQTT flag"

//Cloud Downlink Message Mark: character is "down", followed by "down", representing cloud downlink data.

Note: Boolean data will not have double quotation mark, numeric data will have double quotation mark.

6 Firmware Upgrading

Please contact BLIIoT if it's necessary to upgrade firmware for any new requirements.

This gateway supports upgrading firmware via configuration software. Click About in configuration software, click Firmware Upgrade, select update folder and click OK to confirm. Once upgrading is completed, a prompt box will pop up. Click it to confirm. Contact technical support to get update folder.

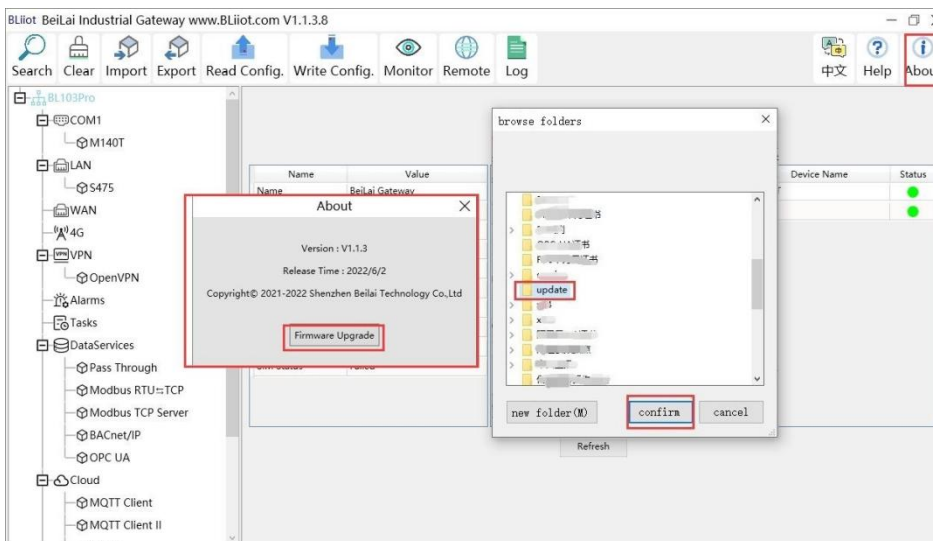

7 Warranty Terms

- 1) This equipment will be repaired free of charge for any material or quality problems within one year from the date of purchase.
- 2) This one-year warranty does not cover any product failure caused by man-made damage, improper operation, etc

8 Technical Support

Shenzhen Beilai Technology Co., Ltd.

Website: <https://www.bliiot.com>