

Monitoring 4 battery voltage
2AIN,2DIN,1 temperature.

BMS 110

Battery Alarm System



BMS110

User Manual

Ver 1.0

Date Issued: 2020-12-10

King Pigeon Hi-Tech. Co., Ltd.

www.IOT-Solution.com

[Reminder-read before use]

With the rapid development of the Industrial Internet of Things, it has been widely used in various fields, but it involves a wide range of knowledge, from sensors, smart meters, gateways, 4G wireless communications, to cloud servers, large-screen displays, APP, etc. The professional knowledge of the user has higher requirements, so the electronic engineer is required to install it. We recommend that you read this article carefully, it will help you quickly and smoothly complete the product setup and implement your application. At the same time, it can save your precious time, no need to read content that has nothing to do with your application.

1. Working Principle

Understanding the working principle of this product helps users quickly understand the working principle of the device, clarify ideas, and realize the functions of these applications.

1) Working principle

This device collects the front-end battery pack voltage, oil level sensor, current transmitter and other data, and after logic processing the abnormal operation, it is sent to the mobile phone number set by the user via SMS or sent to the designated cloud server via the data network. In the cloud server identifies the relationship between the device and the user according to the unique number of the device, and at the same time pushes cloud data to the APP or WeChat official account bound to the user. The following is a schematic diagram of the work through the data network.

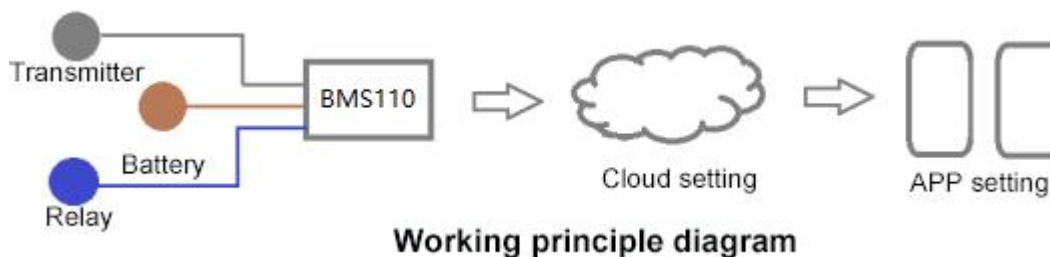

2) Overview of component functions

Sensors, meters, actuators:

According to the types of transmitters and sensors supported by this device, select the appropriate model. There are many types of sensors. Please refer to 1.6 technical parameter description to confirm whether the selected sensor is suitable and whether the wiring is correct.

Cloud platform server:

To connect to the cloud platform, the device needs to set the server target address and port on the BMS110 device side, and then the device initiates the connection actively, and the cloud platform side also needs to set the BMS110 device parameters to receive the data sent by the BMS110 device. After the cloud platform server receives the data, it processes the data according to the rules, stores it in the database, and pushes it to the user. Mobile phone, computer:

First, register an account in the cloud platform and bind the corresponding BMS110 device, so that after the cloud platform receives the data uploaded by the BMS110 device, it can be processed and pushed to the corresponding mobile phone APP and computer users. Similarly, instructions sent by the mobile phone APP or computer will also be sent to the cloud platform first, and then the cloud platform will be pushed to the device.

2. Setup steps overview

This product involves front-end sensors, logic processing of the device itself, cloud platform data management, APP, etc. Therefore, understanding the setting sequence and steps of this product will help



users quickly and orderly set device parameters and connect to the cloud The platform realizes various application functions of users.

Step 1: Hardware settings

Set the local parameters, IO input and output wiring specifications, logical judgment and control, and cloud platform server communication parameter settings according to the manual;

Step 2: Cloud platform settings [If you need to access the cloud platform server, set it on the cloud platform]

Set the relevant parameters of the device on the cloud platform to read the relationship between the device and the user, set the large-screen display content, cloud platform voice alarm, device and video monitoring association, cloud platform SMS alarm, cloud platform mailbox alarm, user management Functions such as permissions.

Step 3: Download APP and bind WeChat [If you need to access the cloud platform server, you need to set it on the cloud platform]

Download the APP and bind the relationship between WeChat and the device. Test and complete the setting.

Therefore, in order to realize the device access to the cloud platform, it is necessary to set the parameters of the device separately and also set it on the cloud platform. The sequence is: set up the device first, and then set the parameters on the cloud platform.

【UPGRADE HISTORY】

DATE	FIRMWARE VERSION	HARDWARE VERSION	DESCRIPTION
2020-12-20	V1.0		

This user manual has been designed as a guide to the installation and operation of BMS 100 battery management system Statements contained in the manual are general guidelines only and in no way are designed to supersede the instructions contained with other products.

We recommend the advice of a registered electrician before any Installation work.

King Pigeon Hi-Tech.Co., Ltd, its employees and distributors, accept no liability for any loss or damage including consequential damage due to reliance on any material contained in this manual.

King Pigeon Hi-Tech.Co., Ltd, its employees and distributors, accept no liability for any Network upgrading or due to the technology specifications contained in this manual.



Table of Contents

[Reminder-read before use]	2
【UPGRADE HISTORY】	3
1. Brief introduction	6
1.1 Overview.....	6
1.2 Application.....	6
1.3 Safety Instructions.....	7
1.4 Standard Packing List.....	7
1.5 Main Features.....	8
1.6 Technical Specifications.....	10
2. Hardware Description	13
2.1 Dimension.....	13
2.2 LED Indicator Light.....	14
2.3 Interface definition.....	15
2.3.1 Analog input.....	15
2.3.2 Battery input.....	17
2.3.3 Digital output.....	17
2.3.4 Digital input.....	18
2.3.5 RTD.....	20
2.3.6 Siren output.....	21
2.3.7 Power input/ output.....	21
2.4 Power switch/upgrade switch.....	22
2.5 Sim Card.....	22
2.6 Connect external antenna.....	23
2.7 USB interface.....	23
3. Installation	23
3.1 Wall mount.....	23
3.2 DIN rail installation.....	24
4. Configuration	24
4.1 Preparation before configuration.....	24
4.1.1 Driver Installation.....	24
4.1.2 Search COM port.....	25
4.1.3 Login configuration software.....	25
4.2 Basic Information.....	27
4.3 Number setting[If access to cloud platform, no need to set].....	28



5. SMS Function.....	48
6. Communication protocol.....	49
6.2 Modbus TCP protocol.....	49
7. Common Application examples.....	50
7.1 Quick verification device.....	50
7.2 Device connect analog transducer.....	51
7.3 Automatic control applications.....	52
7.4 Connect to cloud platform configuration, WeChat push applications.....	54
7.5 Modbus slave application.....	59
8. Update Firmware.....	64
9. Warranty.....	64
10. Technical support.....	64
11. Appendix A SMS Command List.....	64
12. Appendix B Modbus Register Address.....	67
13. Appendix D MQTT Application.....	69

1. Brief introduction

1.1 Overview

BMS110 module can realize 4 battery voltage, 2 analog quantity, 2 digital quantity and 1 temperature measurement, supports Modbus RTU over TCP and MQTT communication protocol, DC9 ~ 36V power supply.

It can be applied to various occasions where storage batteries are used as temporary backup power sources. It can measure 0 ~ 5V, 4 ~ 20mA, 0 ~ 20mA signals output by transmitters such as liquid level, temperature, current, etc., and manage the battery grouping in the computer room and the voltage of each group of batteries. Realize automatic monitoring of battery status, battery surrounding temperature, equipment water immersion, generator oil level, automatic control of inverter to stop working, respectively sending and collecting information to designated user numbers, remote opening of doors, etc. Realize remote information collection of occasions, notification of special personnel and remote control to open the door, so that sudden power outages can be handled faster.

1.2 Application

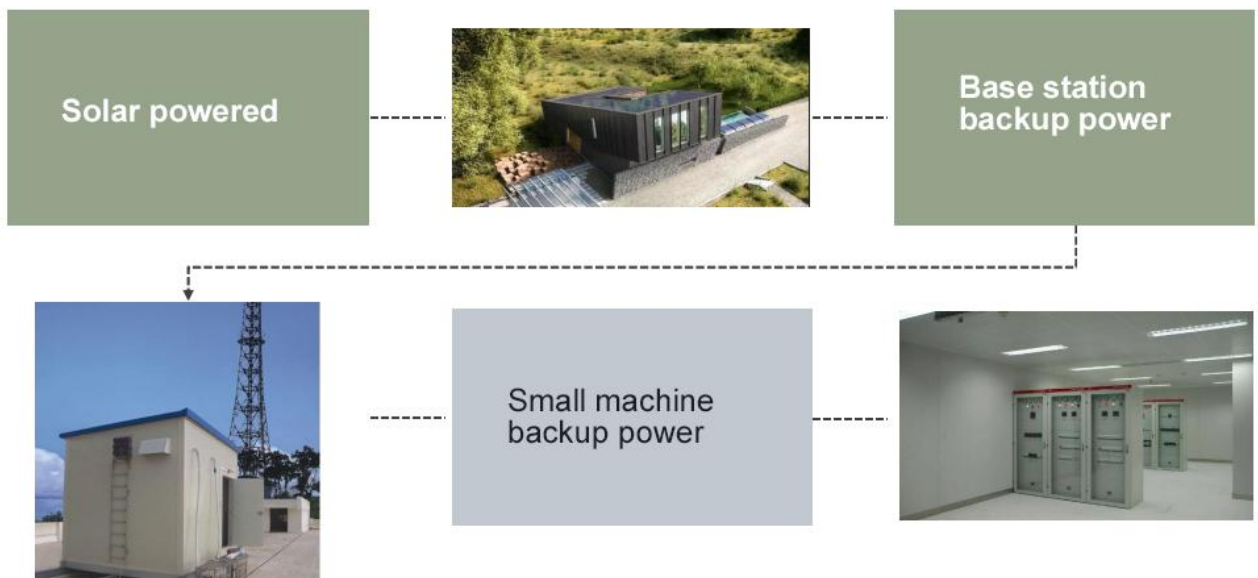

- Computer room battery management and monitoring;
- Remote data acquisition and monitoring fields such as base station transceiver, ATM monitoring, power station monitoring, etc.;
- Telecommunication BTS monitoring;
- Solar battery monitoring;

1.3 Safety Instructions



Safety Instructions

Please do not use this product in places where the use of mobile phones is prohibited!



Wireless Interference

This product uses GSM / GPRS / 3G / 4G wireless network, please pay attention to wireless interference!

Before installing and using this device, please confirm whether the following materials are included in the product box:

1.4 Standard Packing List

- 1x BMS110



- 1x 12bit 3.5mm female jack.

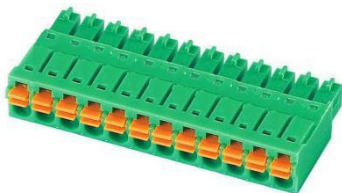

- 1x 14bit 3.5mm female jack.

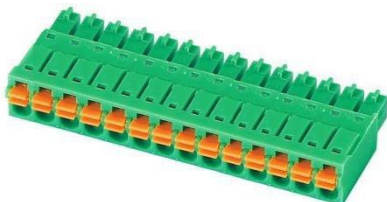

- 1x USB to RS485 cable



- 1x AT-25 Antenna



Note: If the above items are missing or damaged, please contact King Pigeon sales.

Optional accessories (purchase separately)

- DIN35mm rail mounting bracket

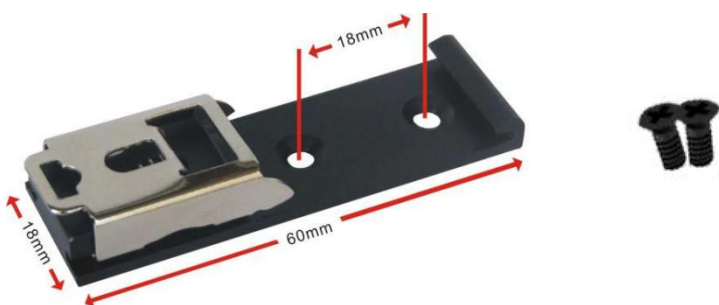

1.5 Main Features

- GSM/GPRS/3G/4G network communication, can be operated from anywhere, no distance;;



Battery Management Alarm System

BMS100

- Embedded ARM® Cortex™-M4 32-bit RISC core real-time operating system, software watchdog and hardware watchdog to prevent false crashes;
- Detect the solar cell voltage and the total voltage of the battery pack, 4 channels 0-15V input detection, the total voltage is 0-60V;
- 2 digital inputs, compatible with dry contacts and wet nodes, NC logic level 0~0.5V , NO logic level 3~30V , and the first digital input can be used as a high-speed pulse counter, sampling frequency is 1MHz, and the second channel supports low-speed pulse counting function, which can be used for tampering alarm and flooding alarm;
- 1 relay output, with a capacity of 5A@250VAC or 5A@30VDC, which can be automatically controlled by timer or event correlation or remotely controlled by SMS, network, and can also be controlled by calling in within the authorized time period through an authorized number. It can be used for battery The group voltage is low to control the inverter to shut down, or link withage equipment;
- 1 PT100 used to monitor the on-site ambient temperature , measurement range is -50~300° C;
- 2 analog inputs, 12-bit resolution, support 0-5V, 4-20mA, 0-20mA output, can be used to detect battery pack load current and diesel generator oil level ;
- Powerful SMS alarm module;
- 1 DC DC power output, no need to add a separate power adapter for the transmitter, saving wiring costs;
- Adopt a complete anti-dropping mechanism to ensure that the data terminal is always online, retransmit data when it is disconnected, and notify users of disconnected SMS;
- Support remote SMS restart device;
- Support 10 user numbers to receive specific SMS alarm information triggered by equipment daily report, offline, abnormality, authorized user numbers can call in to control relay output within authorized time;
- Built-in powerful timer function, supports scheduled automatic reporting, scheduled SMS daily report, scheduled online, scheduled offline, scheduled restart, scheduled relay output, etc.
- Modular structure design, GSM/3G/4G network upgrade only needs to replace the module to realize the network upgrade;
- Support SMS, call, GPRS, 3G, 4G network data remote alarm;
- Support USB interface for parameter configuration, reading, historical record export and program upgrade through computer configuration software; support storage of 1600 fixed report supplementary transmission, 768 alarm supplementary transmission, and 10,000 historical record;
- Built-in high-performance and large-capacity rechargeable lithium battery, once the external power supply fails, the customer can be notified by SMS at the first time, and the standby time is up to 5 hours;
- Embedded TCP/IP protocol stack, Modbus TCP protocol, Modbus RTU over TCP protocol, MQTT protocol, Golden Pigeon IoT RTU protocol, complete anti-dropping mechanism;
- Using industrial-grade chip, built-in watchdog, and has perfect anti-lightning and anti-interference measures to ensure reliability;
- Wall mounting or 35mm standard DIN rail mounting, multiple wiring methods, convenient for field installation and wiring.

1.6 Technical Specifications

Item	Parameter	Description
Power	Power supply voltage	9 ~ 36V DC, Power Requirements: DC12V@1A
	Power Consumption	Standby 80mA@12V
	Output	<ul style="list-style-type: none"> ● 1 channel ● voltage: 9~36V DC (=input voltage) ● Current: 1500mA@12V(Max)
	Power Protection	Anti-reverse connection, ESD air: 15KV, surge: 4KV
	Battery	3.7V/900mA
USB		1*Mini USB
Digital input	Qty	1
	Type	Dry contact and wet contact(NPN)
	Dry contact	<ul style="list-style-type: none"> ● Close: short circuit ● Open: open end
	Wet contact	<ul style="list-style-type: none"> ● Close: 0-0.5VDC ● Open: 3-30VDC
	Other	Support DI0 as a high-speed pulse counter, sampling frequency: 1MHz; Support DI1 as a low-speed pulse counter, and the anti-shake time can be set from 1 to 2000ms;
Digital output	Isolation protection	2KVrms
	Qty	1
	Type	Relay output, normally open, action output normally closed
	capacity	5A@250VAC or 5A@30VDC
	other	Support DO can be controlled calling Support custom setting closing and opening time
Siren	Isolation protection	2KVrms
	Qty	1
	Type	12V DC
	Max output	500mA@12V
Analog Input	other	Support custom setting closing and opening time
	Qty	2 Channel
	Input way	Differential input
	Input type	4-20mA/0-20mA/0-5V
	Resolution	12Bit
Accuracy		±0.1% FSR @ 25 °C
		±0.3% FSR @ -10 and 60 °C



		±0.5% FSR @ -40 and 75 °C
	Sampling frequency	200ms
	Input resistance	>1M ohms
RTD	Qty	1 Channel
	Input way	2/3 wire
	Measure range	-50~300°C
	Resolution	12Bit
	Accuracy	<ul style="list-style-type: none"> ● ±0.1% FSR @ 25°C ● ±0.3% FSR @ -10 and 60°C ● ±0.5% FSR @ -40 and 75°C
	Sampling frequency	200ms
Battery input	Qty	4
	Input way	Differential input
	Measure range	0~15V DC
	Resolution	12Bit
	Accuracy	±0.2%FSR@25°C
	Sampling frequency	200ms
Cellular network	2G	GSM/EDGE: 850,900,1800,1900MHz
	3G	GSM/EDGE: 850,900,1800,1900MHz UMTS: 850,900,2100MHz
	4G (L-E)	GSM/EDGE: 900,1800MHz WCDMA: B1,B5,B8 FDD: B1,B3,B5,B7,B8,B20 TDD: B38,B40,B41
	4G (L-AU)	GSM/EDGE: 850,900,1800MHz WCDMA: B1,B2,B5,B8 FDD: B1,B2,B3,B4,B5,B7,B8,B28 TDD: B40
	4G (L-A)	WCDMA: B2,B4,B5 FDD: B2,B4,B12
	4G (L-V)	FDD: B4,B13
	4G (L-J)	WCDMA: B1,B3,B8,B18,B19, B26 FDD: B2,B4,B12 TDD: B41



	4G (L-CE)	GSM/EDGE: 900,1800MHz WCDMA: B1,B8 TD-SCDMA: B34,B39 FDD: B1,B3,B8 TDD: B38,B39,B40,B41
	SIM/UIM	Standard drawer interface, support 1.8V/3V SIM/UIM card, built-in 15KV ESD protection
Certification	MTBF	≥100,000 hours
	EMC	EN 55022: 2006/A1: 2007 (CE &RE) Class B
		IEC 61000-4-2 (ESD) Level 4
		IEC 61000-4-3 (RS) Level 4
		IEC 61000-4-4 (EFT) Level 4
		IEC 61000-4-5 (Surge)Level 3
		IEC 61000-4-6 (CS)Level 4
Other	CE,FCC,ROHS	
Environment	Working temp& humi	-45~85℃,5~95% RH
	Storage temp& humi	-45~105℃,5~95% RH
Others	Shell	metal
	Size	105mm×88mm×30mm
	Protection level	IP30
	Net weight	250g
	Installation method	Wall-mounted, rail-mounted

2. Hardware Description

2.1 Dimension

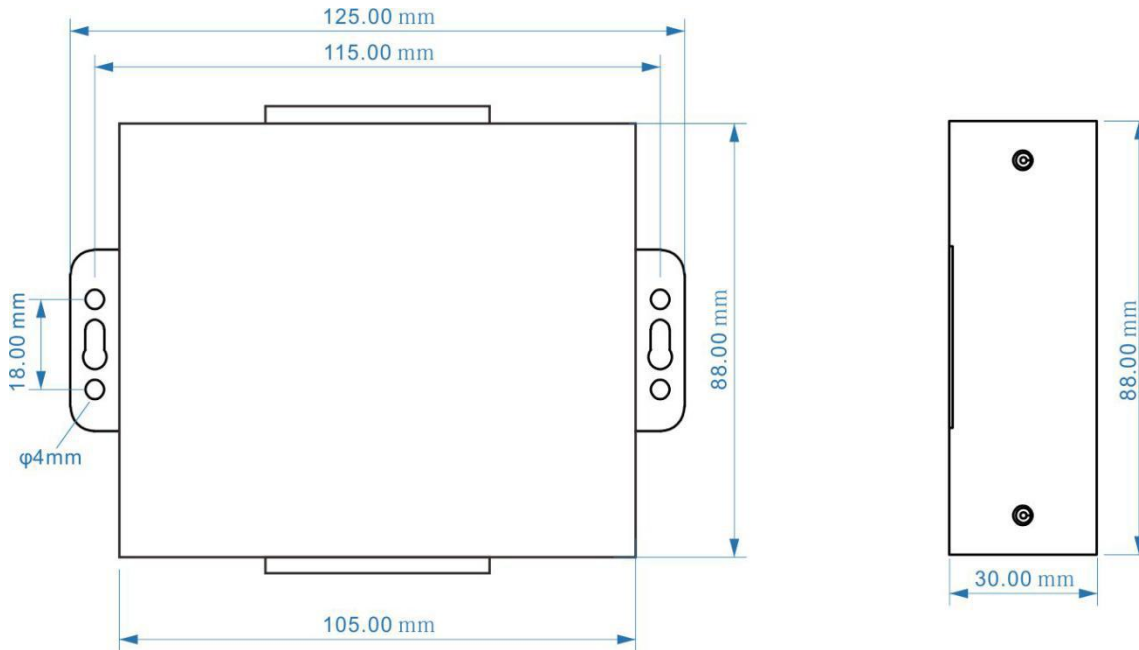

2.2 LED Indicator Light

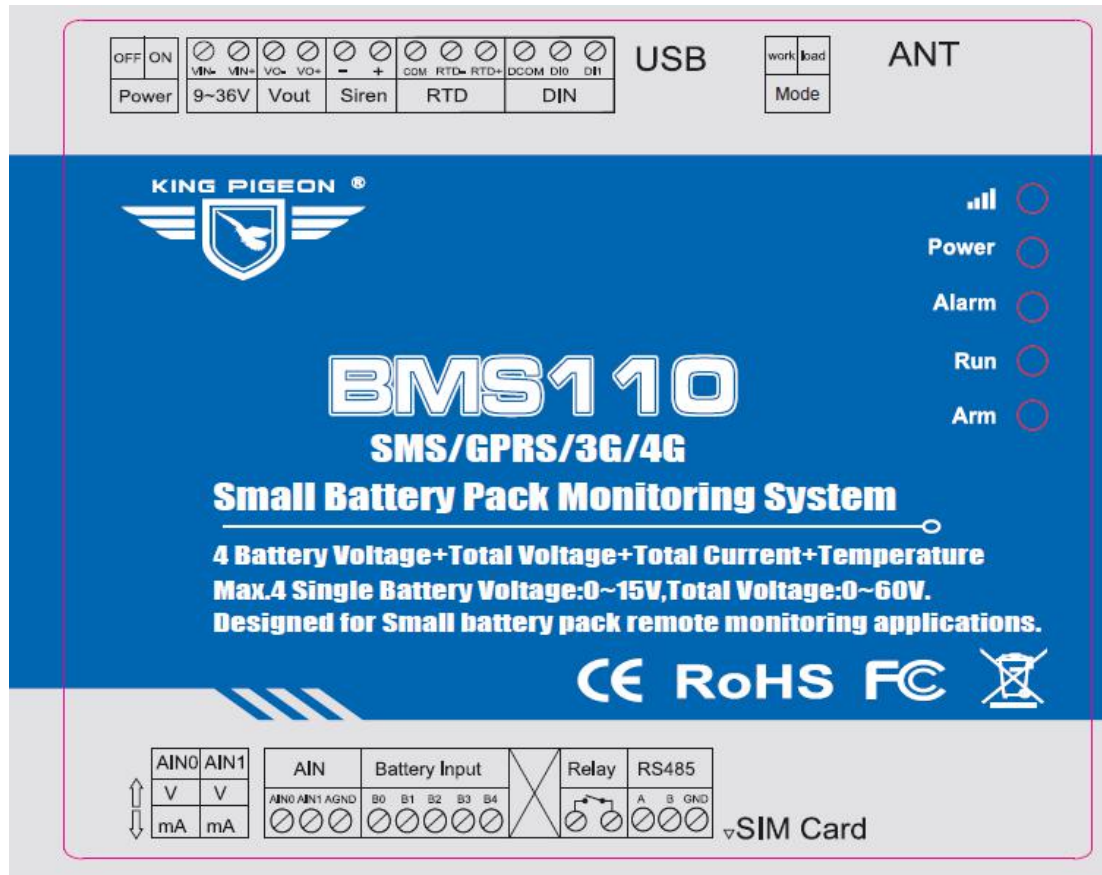

LED Indicator Light					
No.	Symbol	Name	Color	Status	Description
1		4G signal	red	Flick fast	2G:no signal (off 0.8s, on 0.2s) ; 3G/4G: no signal (off 2S, on 0.2s) ;
				Flick slowly	2G: normal (off 2S, on 0.2s) ; 3G/4G:normal (off 0.2S, on 2s) ;
				off	Communication module is abnormal
2	Power	Power indicator	red	on	External power supply is normal
				off	External power failure
3	Alarm	Alarm indicator	red	on	Alarm triggered
				off	No alarm
4	Run	Running indicator	red	Flashing	System is running
				off	System stopped
5	Arm	Arm indicator	red	on	Arm
				off	Disarm

2.3 Interface definition

2.3.1 Analog input

Note:

According to the transmitter output type is current (mA) or voltage (V) type, Generally used to connect the current transmitter for measuring the battery load and the liquid level sensor for detecting the oil level of the fuel tank. Set the DIP switch of the corresponding channel to the corresponding position on the device, as shown below.

Mode Selection			
NO.	Function		Description
1	AIN0	V	The first analog input type is set to "0-5V"
		mA	The first analog input type is set to "0-20mA" or "4-20mA"
2	AIN1	V	Set the 2nd analog input type to "0-5V"
		mA	The 2nd analog input type is set to "0-20mA" or "4-20mA"

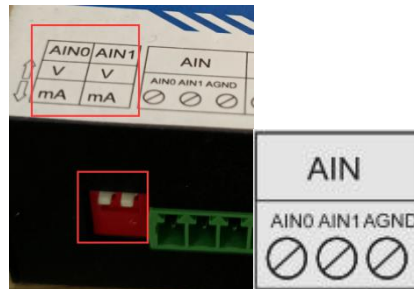

AIN		
NO.	Function	Description
1	AIN0	The first analog input positive interface
2	AIN1	The 2nd analog input positive interface
3	AGND	No. 1 and No. 2 analog input negative interface

AI internal interface principle diagram:

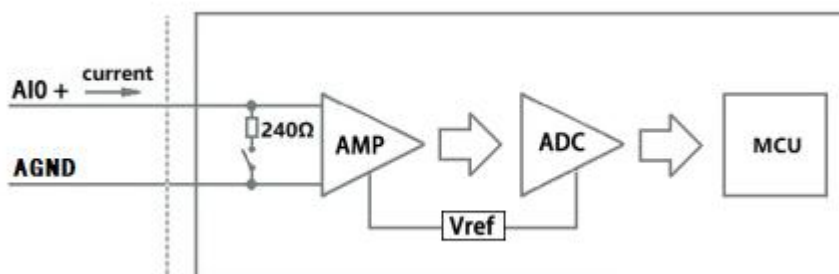

AI input wiring diagram:

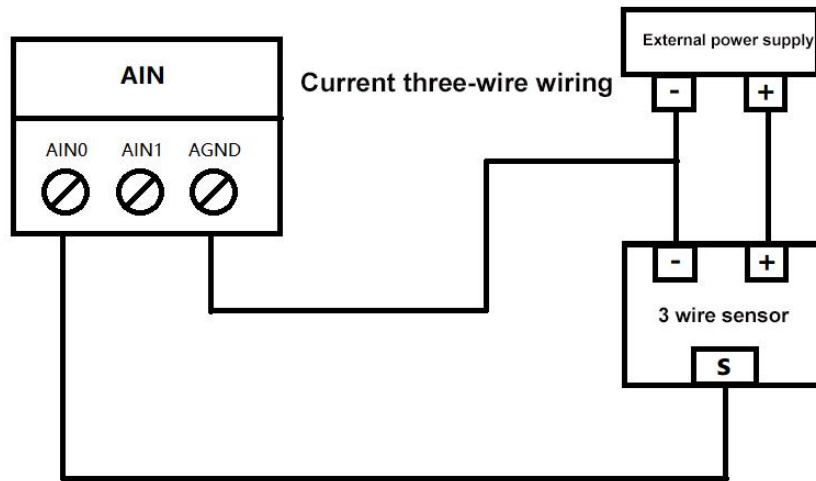
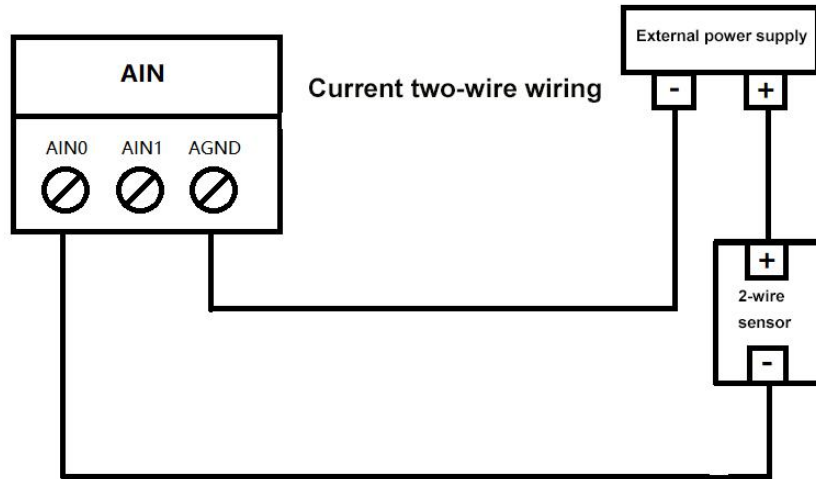

Voltage type:

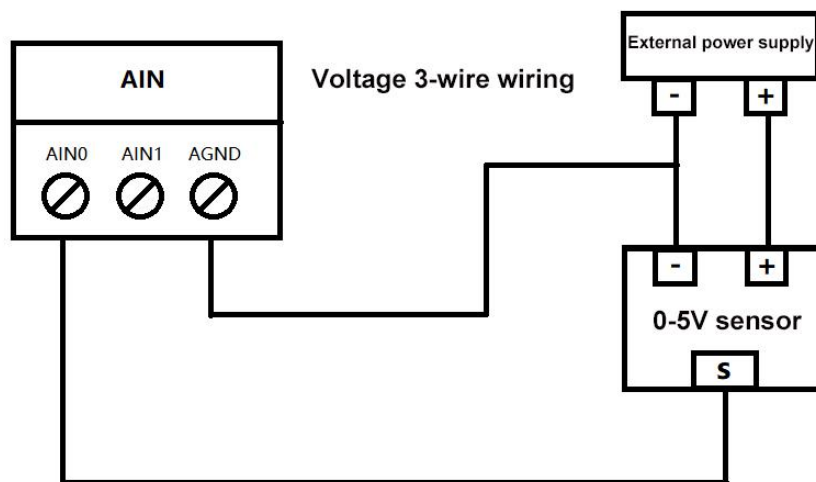

2.3.2 Battery input

Max connect 4 batteries, and the voltage of a single battery is 0-15V. It can read the voltage of each battery and the voltage of the total battery pack.

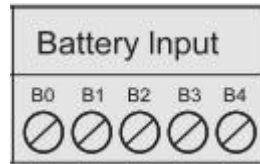

Battery Input		
NO.	Function	Description
1	B0	The first battery voltage input negative port
2	B1	The first battery voltage input positive interface / 2nd battery voltage input negative port
3	B2	2nd battery voltage input positive interface / The 3rd battery voltage input negative port
4	B3	The third battery voltage input positive interface / The 4th battery voltage input negative port
5	B4	The 4th battery voltage input positive port

Wiring diagram:

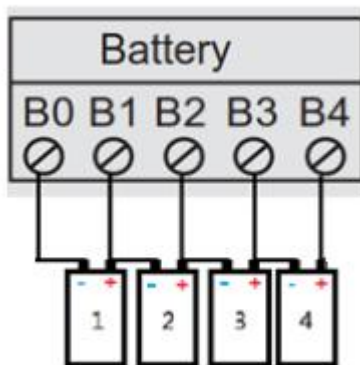

2.3.3 Digital output

Support one DO (Relay) output, which can be connected to control door opening, control fan, control inverter to stop working, etc.



DO		
NO	Function	Description
1	Relay	Relay output

DO Internal interface schematic:

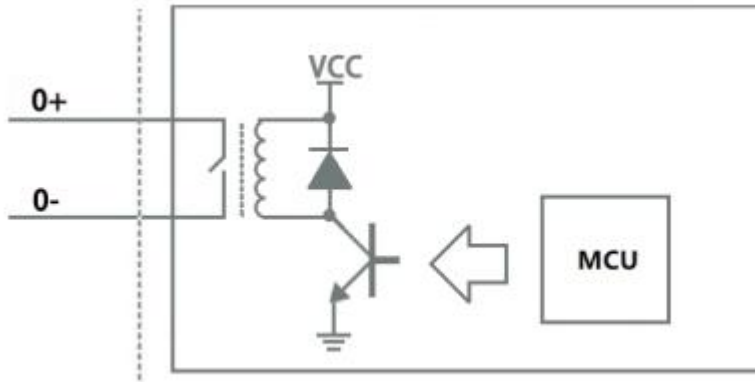

DO Wiring diagram:

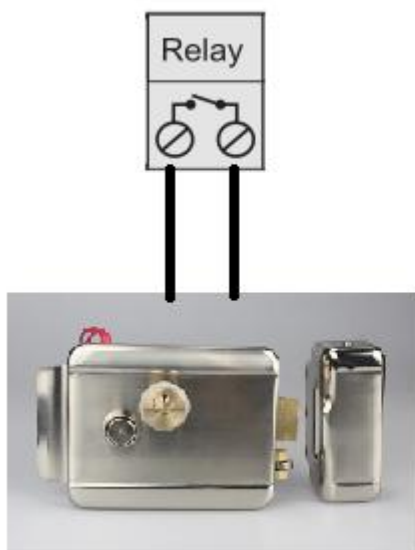

For remote gate open

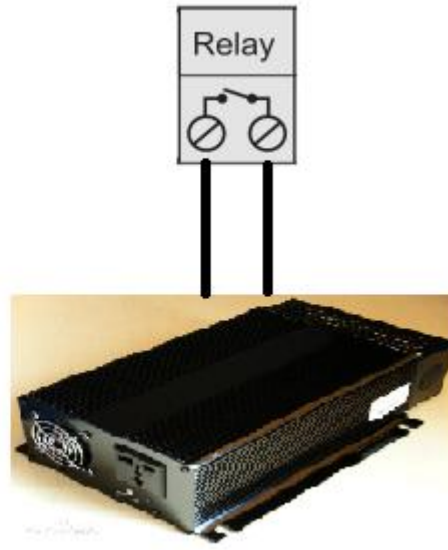

for inverter control

2.3.4 Digital input

2 DI can be connected to door sensor, anti-dismantling sensor, water immersion sensor, etc. Automatically trigger device alarms.



DIN		
NO	Function	Description
1	DCOM	Common ground
2	DI0	The first digital input, supports high-speed pulse counting, sampling frequency: 1MHz;
3	DI1	The second digital input supports low-speed pulse counting.

Note:

DI0 Support high-speed pulse counting, sampling frequency: 1MHz;

DI1 Support low-speed pulse counter, anti-shake time can be set 1~2000ms。

DI Internal interface schematic:

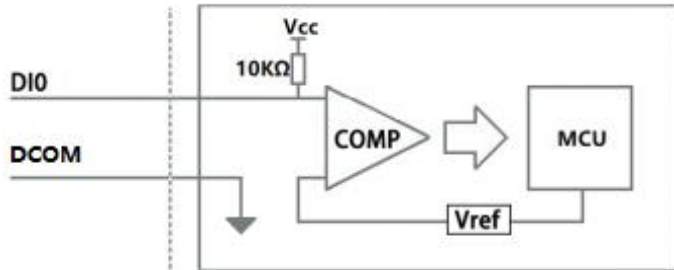

DI Wiring diagram:

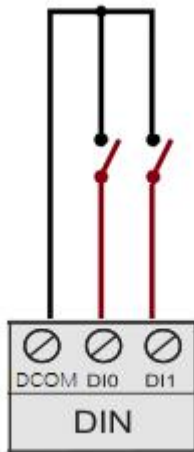

DI Wiring diagram(NPN sensor):

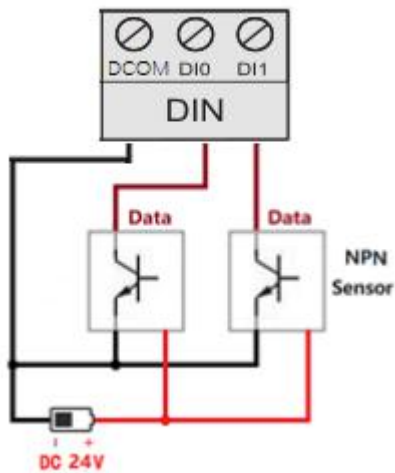

2.3.5 RTD

One PT100 temperature sensor is used to detect the environment or fixed-point temperature.



RTD		
NO	Function	Description
1	RTD+	PT100 positive
2	RTD-	PT100 negative
3	COM	PT100 COM

RTD Internal interface schematic:

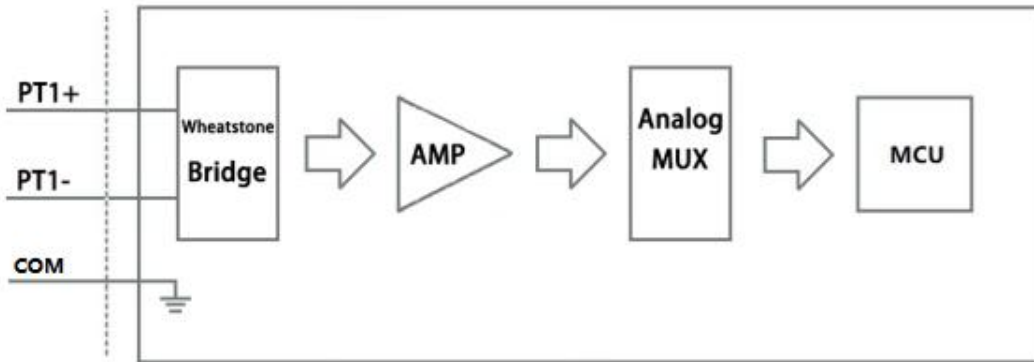

RTD Wiring diagram:

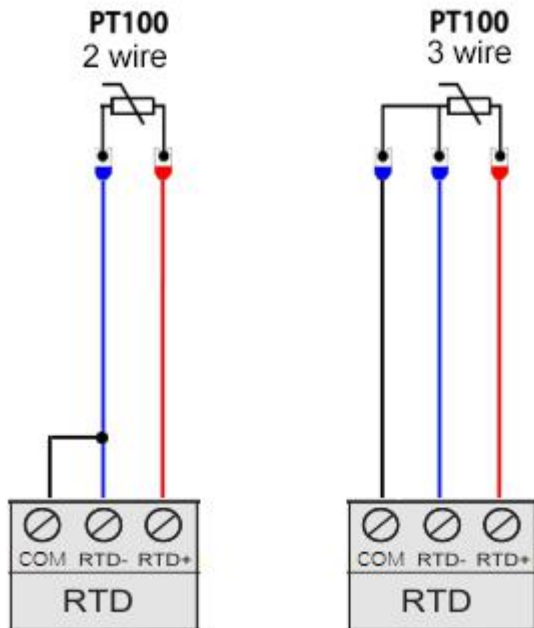

2.3.6 Siren output

It supports 1 siren output, which can control the siren to light up at the same time as the upper and lower limits of temperature, the upper and lower limits of battery voltage, the current load is too high, and the DIN sensor triggers an alarm.



Siren		
NO	Function	Description
1	+	Output positive
2	-	Output negative

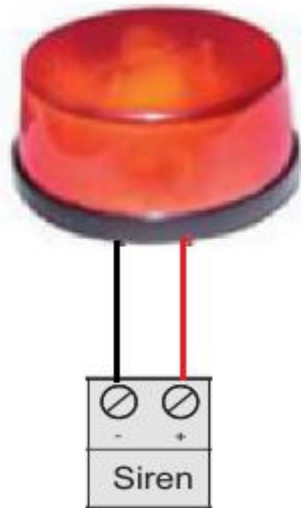

2.3.7 Power input/ output



Power supply		
NO	Function	Description
1	VIN-	The negative power input is used to power the device.
2	VIN+	The positive power input is used to power the device.
3	VO-	The negative power output is used to supply power to external devices.
4	VO+	The positive power output is used to supply power to external devices.

2.4 Power switch/upgrade switch



Power switch		
NO	Function	Description
1	OFF	Turn off
2	ON	Turn on

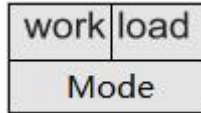

Upgrade switch		
NO	Function	Description
1	work	Normal working mode
2	load	Program upgrade mode

2.5 Sim Card

When inserting/removing the SIM card, make sure that the device is turned off first, insert the card-removing pin into the small hole of the card slot, and press it firmly to push the card slot out.



2.6 Connect external antenna

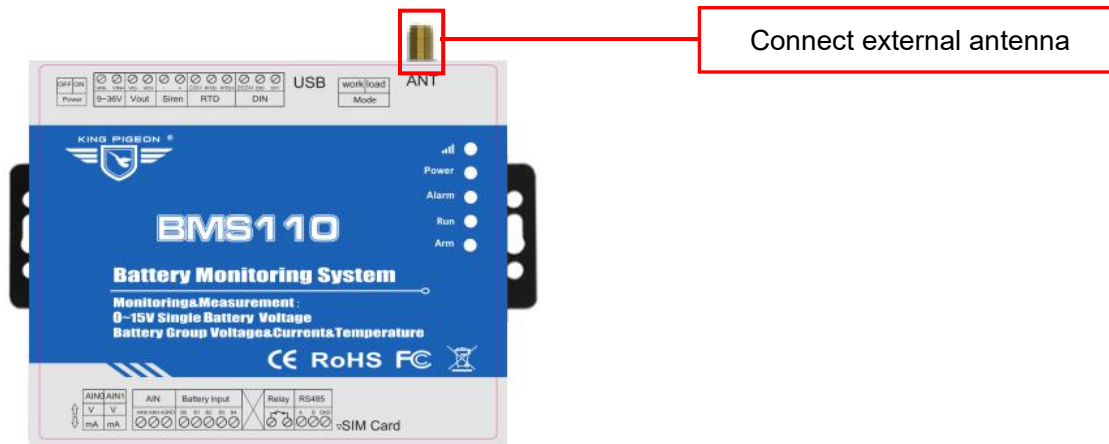

2.7 USB interface

The Mini USB interface can be used to connect the BMS100 and the PC, to set parameters, and to upgrade the firmware.



3. Installation

Support horizontal desktop placement, wall-mounted and rail installation,

3.1 Wall mount





3.2 DIN rail installation

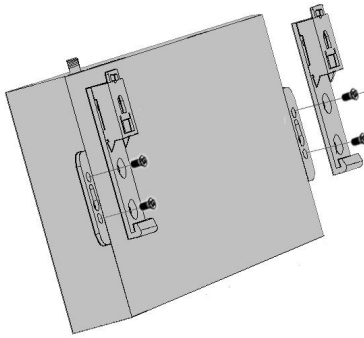

Snap-in installation

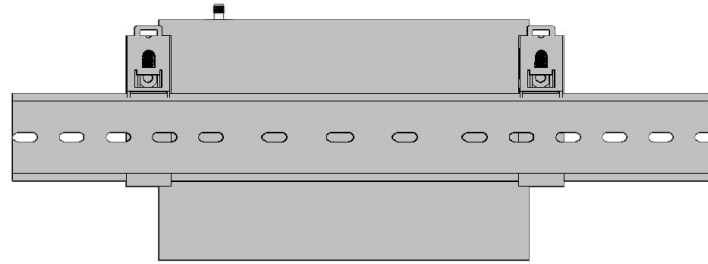

Rail installation

4. Configuration

4.1 Preparation before configuration

A quick understanding of the entire setup process will help you quickly complete the setup of the entire device and avoid the problem of missed or misoperation causing setup failure. The following will explain the setup steps of the entire device, please read carefully.

Note:

When using an IoT card, it does not support sending and receiving text messages and voice dialing alarm functions, so there is no need to set the content related to text messages; at the same time, when the device wants to access the cloud platform server, please disable the SMS alarm and dialing functions, otherwise the device Frequent offline due to sending and receiving text messages and dialing.

4.1.1 Driver Installation

If the USB driver of the device is already installed on the computer, you can skip this step.

Method 1: Download the configuration software and USB driver of BMS110 from www.iot-solution.com, then decompress and install;

Method 2: Scan the QR code card in the product box to download the configuration software and USB driver of the BMS110, then decompress and install;

Method 3: Download the universal driver, such as "Drive Life", etc., and install it on the computer, and then scan the hardware to install the driver.

4.1.2 Search COM port

Right-click [My Computer], click "[Properties]> [Device Manager]> [Port]", if the connection is normal and the driver installation is normal, it will display Silicon Labs CP210x USB to Uart Bridge, as shown below (local port The number is COM4):

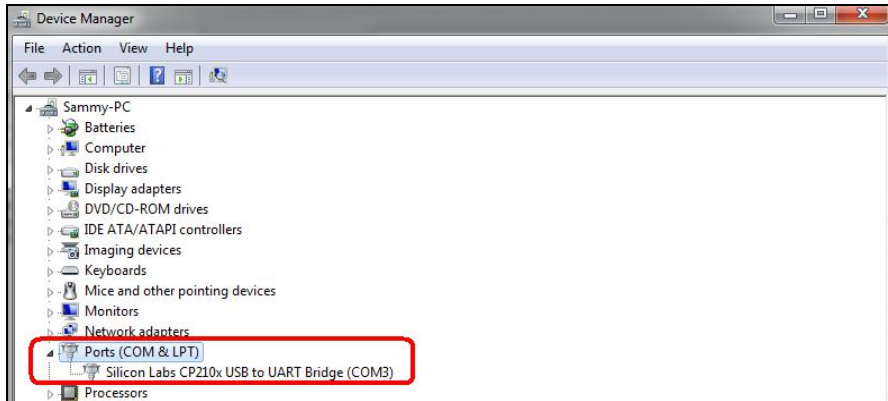

4.1.3 Login Configuration software

Turn on the device, run the configuration software "BMS110_Configuration Software.exe" on the computer, select the correct COM port, which is the port number displayed in the [Device Manager], enter the password (default 1234), and click [OK], as shown in the figure below Shown:



Select Sim card type and click "Enter Setting", after successful login, the software interface is shown in the following figure:

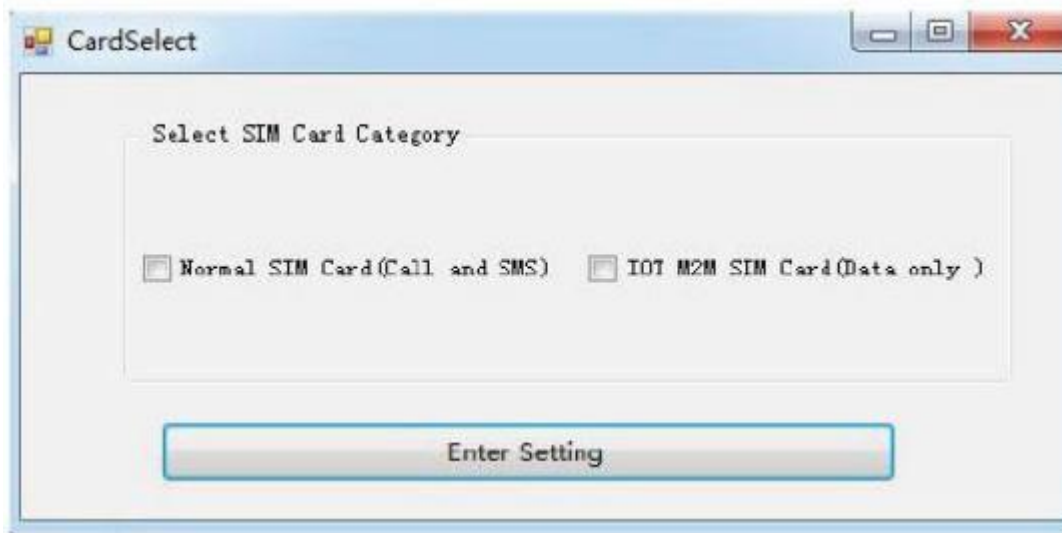

After successful login, the software interface is as shown in the figure below:

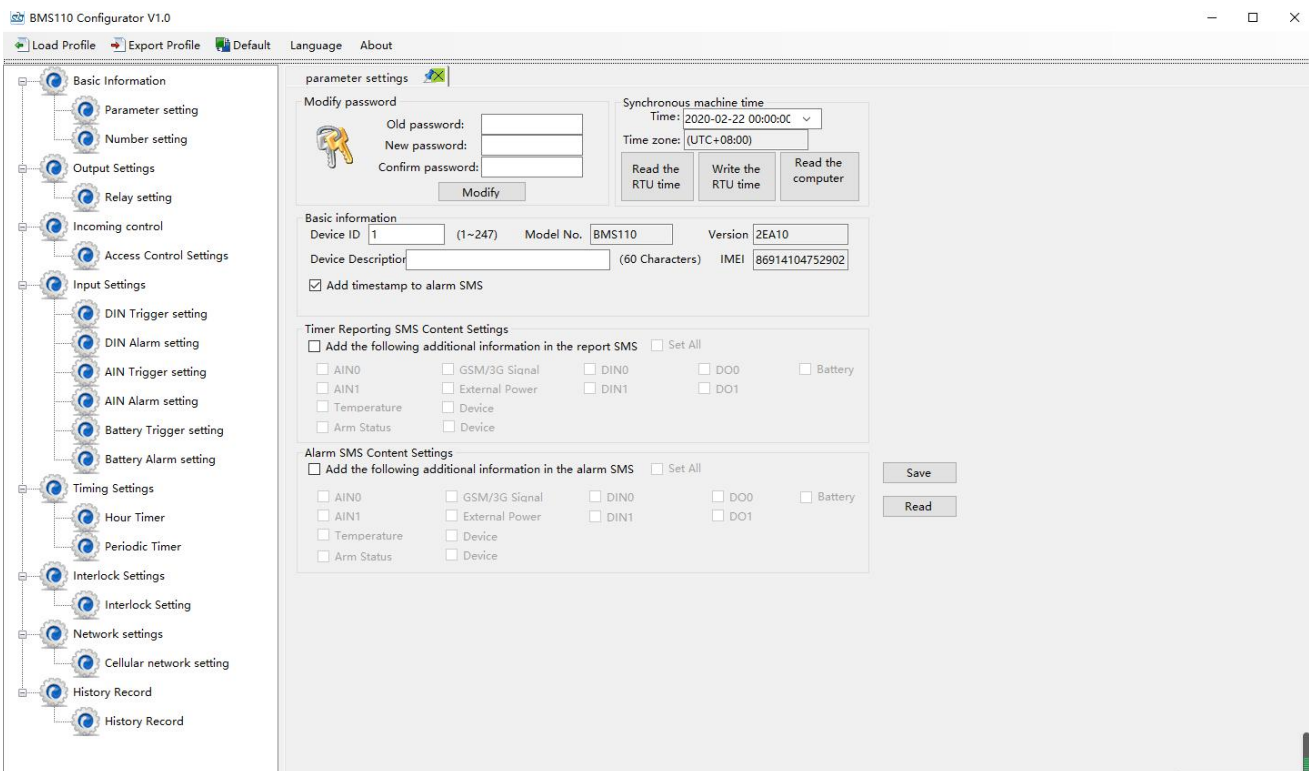

In the software interface, users can perform operations such as writing configuration, reading configuration, and changing passwords.

The steps to modify the configuration are as follows:

1. Modify in the current interface;
2. Click the "write" button in the upper right corner of the current page, click "OK" in the pop-up dialog box, when the red "write successful" appears, it means the modification is successful;
3. After all modifications are completed, please shut down and restart the device (turn the power switch to "OFF" and then back to "ON").

4.2 Basic Information

Note: When accessing the cloud platform, the [Automatic report setting] item and [Alarm SMS setting] item may not be set.

Through this page, users can quickly configure the basic information of the device, including modifying the device password, synchronizing the device time, device ID number, device description, the content of the regular SMS report, and the content attached to the alarm SMS when an alarm occurs. details as follows

Run the BMS100 configuration software on the computer, select the correct COM port, that is, the port number displayed in [Device Manager], and click [Open], as shown below:

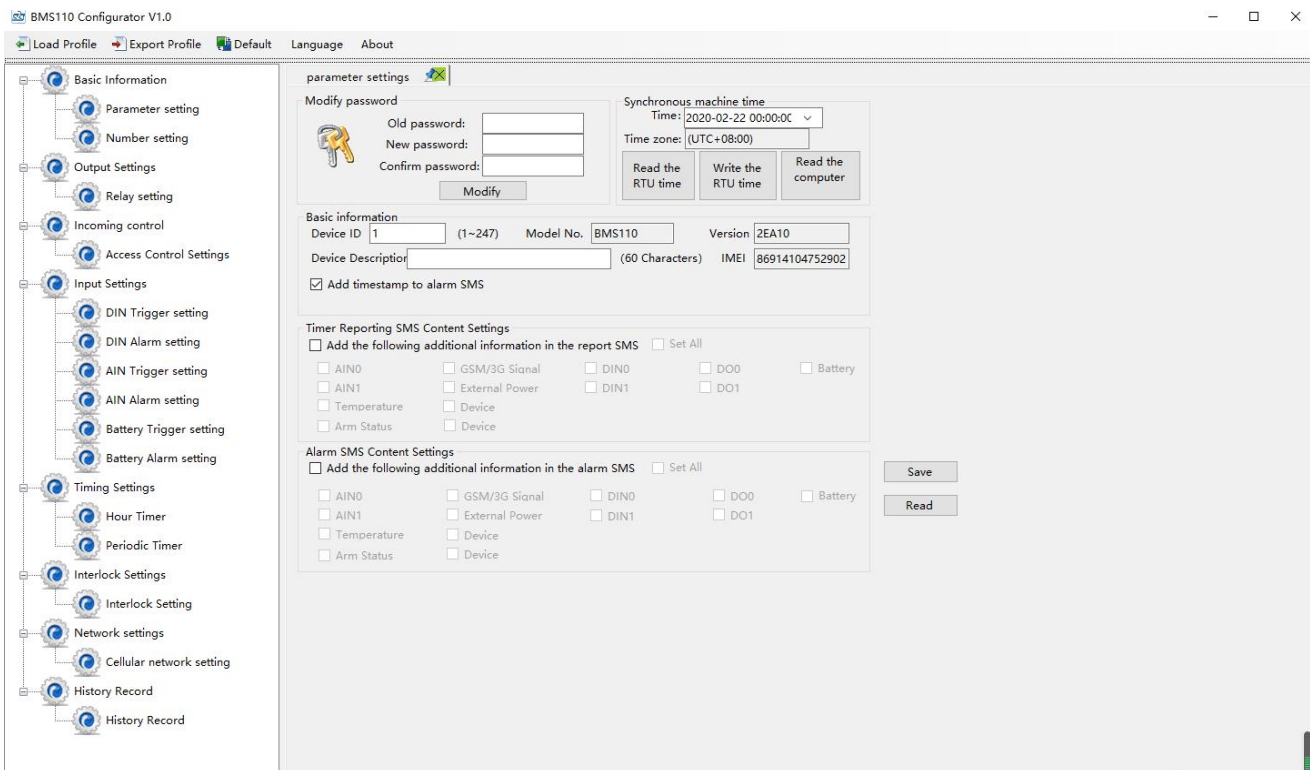

Modify Password@Basic information		
Item	Description	Default
Old password	Enter old password	null
New password	Enter new password	null
Confirm password	Confirm password	null
Modify	Click to valid	--

Synchronize machine time@Basic information		
Item	Description	Default
Time	Display/select device current time	--
Time zone	Display current time zone	--
Read RTU time	After clicking, it will read the RTU time and display it	--
Write RTU time	After clicking, the current computer time and time zone	--



		will be written into the RTU	
Read the computer		Read computer current time	--

Basic information@Basic information		
Item	Description	Default
Device ID	When used in Modbus protocol as the local device ID address, range: 1-247	1
Model NO.	Device model automatically read	--
Version	Automatically read device version number	--
Device description	After setting the description content, the alarm message will be accompanied by device description information.	null
IMEI	Automatically read device module IMEI number	--
Add timestamp to alarm sms	ticked, the text message content will be accompanied by time information	ticked

Time reporting SMS content setting@Basic information		
Item	Description	Default
Add the following additional information in the report sms	After checking the following options, if the selected item is set for timing event, it will be sent to the authorized number of the alarm receiver. Set it on the "Number Settings" page to achieve the timing of SMS reporting. A condition: set timed SMS reporting, there is a tick option here, and there are alarm receivers who can receive	untick

Alarm sms content setting@Basic information		
Item	Description	Default
Add the following additional information in the alarm sms	After ticked, when the selected item and other items alarm, the status of the item will be sent to the alarm receiver together	untick

4.3 Number setting **[If access to cloud platform, no need to set]**

Note: When using IoT card, it does not support sending and receiving SMS and voice dialing alarm functions, so there is no need to set the content related to SMS; at the same time, when the device is to access the cloud platform server, please disable the SMS alarm and dialing function, otherwise the device will Sending and receiving text messages and dialing leads to frequent offline. No need set.

You can quickly configure the user number and its corresponding authority, such as which event alarm information to receive. details as follows:



Battery Management Alarm System BMS100

BMS110 Configurator V1.0

Load Profile Export Profile Default Language About

parameter settings Number setting

Authorized User Telephone Number Settings

(Alarm No.)	Power On	Timer Report	Low Signal	Disarm	Power Lost	Power Recovery	GPRS Failure	Relay Switch
User No.0	<input type="checkbox"/>	<input type="checkbox"/>	<input type="checkbox"/>	<input checked="" type="checkbox"/>	<input type="checkbox"/>	<input type="checkbox"/>	<input type="checkbox"/>	<input type="checkbox"/>
User No.1	<input type="checkbox"/>	<input type="checkbox"/>	<input type="checkbox"/>	<input type="checkbox"/>	<input type="checkbox"/>	<input type="checkbox"/>	<input type="checkbox"/>	<input type="checkbox"/>
User No.2	<input type="checkbox"/>	<input type="checkbox"/>	<input type="checkbox"/>	<input type="checkbox"/>	<input type="checkbox"/>	<input type="checkbox"/>	<input type="checkbox"/>	<input type="checkbox"/>
User No.3	<input type="checkbox"/>	<input type="checkbox"/>	<input type="checkbox"/>	<input type="checkbox"/>	<input type="checkbox"/>	<input type="checkbox"/>	<input type="checkbox"/>	<input type="checkbox"/>
User No.4	<input type="checkbox"/>	<input type="checkbox"/>	<input type="checkbox"/>	<input type="checkbox"/>	<input type="checkbox"/>	<input type="checkbox"/>	<input type="checkbox"/>	<input type="checkbox"/>
User No.5	<input type="checkbox"/>	<input type="checkbox"/>	<input type="checkbox"/>	<input type="checkbox"/>	<input type="checkbox"/>	<input type="checkbox"/>	<input type="checkbox"/>	<input type="checkbox"/>
User No.6	<input type="checkbox"/>	<input type="checkbox"/>	<input type="checkbox"/>	<input type="checkbox"/>	<input type="checkbox"/>	<input type="checkbox"/>	<input type="checkbox"/>	<input type="checkbox"/>
User No.7	<input type="checkbox"/>	<input type="checkbox"/>	<input type="checkbox"/>	<input type="checkbox"/>	<input type="checkbox"/>	<input type="checkbox"/>	<input type="checkbox"/>	<input type="checkbox"/>
User No.8	<input type="checkbox"/>	<input type="checkbox"/>	<input type="checkbox"/>	<input type="checkbox"/>	<input type="checkbox"/>	<input type="checkbox"/>	<input type="checkbox"/>	<input type="checkbox"/>
User No.9	<input type="checkbox"/>	<input type="checkbox"/>	<input type="checkbox"/>	<input type="checkbox"/>	<input type="checkbox"/>	<input type="checkbox"/>	<input type="checkbox"/>	<input type="checkbox"/>

Read Save

Notice:
 1. Alarm No. can include or non-include country code, e.g.in UK,can setup 0044 or +44 or without country code,but can not be 44.
 2. Low signal alert: Mobile signal lower than 14 (full signal is 31).
 3. Tick it stands for when the event occurrence, will send SMS to the related telephone numbers.

Number setting		
Item	Description	Default
User No	Used to set the receiving alarm number, supports 10	--
Power on	When the device is turned on, it sends a boot message to the number, including the device model, version number, device description, device status, cellular network signal value, IMEI and other information	--
Timer Report	Tick it, after setting the timed reporting of SMS events and reporting content, the SMS content to be reported will be sent to this number at the set time	--
Low signal	When the signal value is lower than 14, send sms to notify the phone number	--
Arm/disarm	When the device changes the arm and disarm status, send a sms to notify this phone number	--
Power lost	If the external power supply is lost, send SMS to notify this number	--
Power recovery	When the external power supply is restored, send sms to notify this number	--
GPRS failure	If you fail to connect to the server 3 times, will be notified by SMS	--
Relay switch	This is the main switch for relay displacement SMS. After a certain relay "reset SMS" is checked, a SMS will be sent to notify this number	--

4.4 Output setting

Note: When accessing the cloud platform, the channel name, variable SMS, closing description, and disconnect description items no need set.

Through this page, you can quickly set the characteristics of the relay output, such as setting the purpose of the relay, the length of time the relay is closed, the number of times of closing, and the interval between each time.

This device supports 1 relay output, rated range: 5A/30VDC, 5A/250VAC. It can be set to call in by the authorized number for control, or remotely controlled by SMS, or automatically controlled by timer, event association, or remotely controlled by the monitoring center or cloud platform. Meet most of the applications and the application requirements of automatic control.

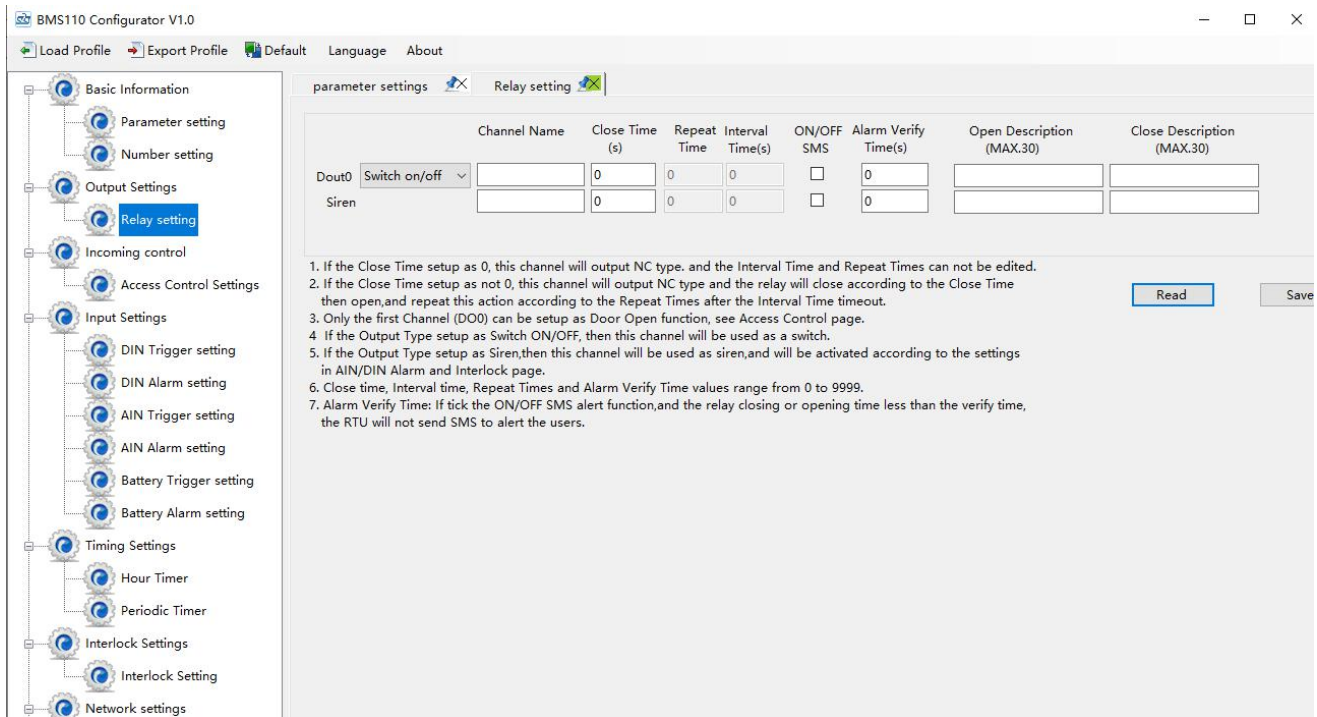

Output setting		
Item	Description	Default
Output type	<ul style="list-style-type: none"> Open door:: after enabling, the channel will close after the authorized number calls in and the device will be automatically set to the arming state; Switch on/off: relay as a common switch, can be used as normal timing events, linkage events, SMS control to use. 	switch
Siren	the unique function channel will be closed after the audio function in the "input settings" page is triggered	
Channel name	User defined channel name, used for channel description when SMS alarm.	null
Close time	Channel close time, unit: seconds. 0 means always close	0

Repeat time	The number of times that the relay is repeatedly closed when the relay action is performed.	0
Interval time	That is to say, the timing starts after each closing and breaking, and the interval is how long to close again. When combined with "times", it can achieve the result of pulse output, unit second.	0
On/off SMS	The original SMS number will be sent to the user when the status changes.	Not selected
Alarm verify time	After the relay is shifted, the alarm will be delayed for a period of time.	2
Open description	It is used to describe the status of "disconnection" in the content of SMS when [displacement] alarm is given.	empty
Close description	It is used to describe the "closed" state in the SMS content when [displacement] alarm is given.	empty

4.5 Access Control [If access to cloud platform, no need to set]

Through this page, the user can quickly set the authority number and authorization period of the call in control. This function brings great convenience to the remote control of the electronic lock in the unattended computer room. It can remotely authorize a maintenance personnel to open the door by calling in with their own mobile phone within a limited period of time, which solves the traditional problem of taking and delivering keys and cumbersome approval process. Of course, you can also set various parameters of this page through SMS, cloud platform and monitoring center.

The number is the phone number corresponding to the serial number on the [Number Settings] page. When you call the mobile phone card number in the device during the start time and end time period, the device will automatically perform actions on relay 0 according to the preset parameters, such as Relay 0 is connected to the electric control lock to achieve the effect of opening the door, and the device will automatically disarm. If permanent is checked, it will be permanently effective regardless of the termination time.

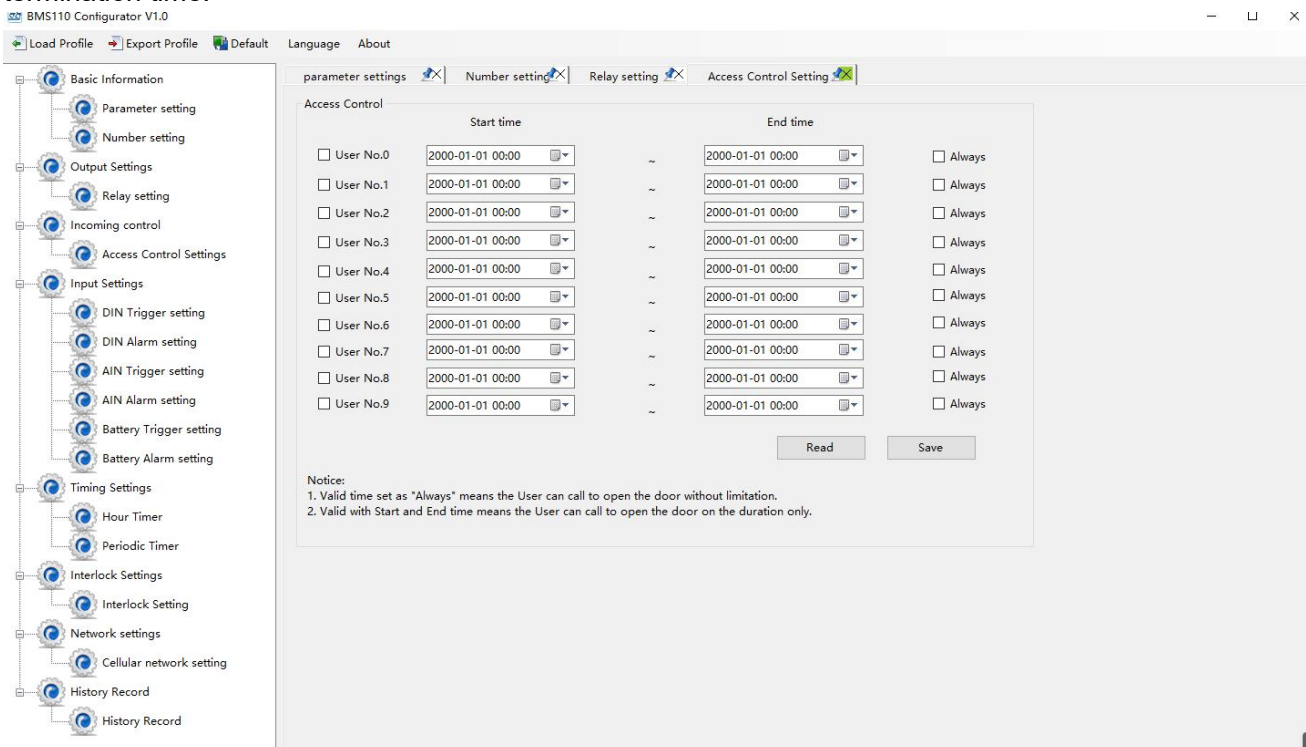

Access Control

	Start time	End time	
<input type="checkbox"/> User No.0	2000-01-01 00:00	2000-01-01 00:00	<input type="checkbox"/> Always
<input type="checkbox"/> User No.1	2000-01-01 00:00	2000-01-01 00:00	<input type="checkbox"/> Always
<input type="checkbox"/> User No.2	2000-01-01 00:00	2000-01-01 00:00	<input type="checkbox"/> Always
<input type="checkbox"/> User No.3	2000-01-01 00:00	2000-01-01 00:00	<input type="checkbox"/> Always
<input type="checkbox"/> User No.4	2000-01-01 00:00	2000-01-01 00:00	<input type="checkbox"/> Always
<input type="checkbox"/> User No.5	2000-01-01 00:00	2000-01-01 00:00	<input type="checkbox"/> Always
<input type="checkbox"/> User No.6	2000-01-01 00:00	2000-01-01 00:00	<input type="checkbox"/> Always
<input type="checkbox"/> User No.7	2000-01-01 00:00	2000-01-01 00:00	<input type="checkbox"/> Always
<input type="checkbox"/> User No.8	2000-01-01 00:00	2000-01-01 00:00	<input type="checkbox"/> Always
<input type="checkbox"/> User No.9	2000-01-01 00:00	2000-01-01 00:00	<input type="checkbox"/> Always

Notice:
 1. Valid time set as "Always" means the User can call to open the door without limitation.
 2. Valid with Start and End time means the User can call to open the door on the duration only.



Access control		
Item	Description	Default
Number (0-9)	Phone number corresponding to serial number in [number setting] page	Not selected
Start time	Set the start time of user number call in permission	--
End time	Set the end time of user number call in permission	--
Always	After checking, the corresponding user number can call in and open the door at any time	Not selected

4.6 Input Setting

Through this page, users can quickly configure the purpose and parameters of digital input, such as deployment and deployment, pulse counting, displacement monitoring and triggering alarm, etc.

4.6.1 DI trigger setting

Note: when the IOT network card is used, the functions of sending and receiving SMS and voice dialing alarm are not supported, so the content related to SMS does not need to be set; at the same time, when the device wants to access the cloud platform server, please prohibit the SMS alarm and dialing function, otherwise the device will be offline frequently because of sending and receiving SMS and dialing. Do not set this page, the content in this box will not be prompted below.

Note: when accessing the cloud platform, the items of [alarm SMS], [restore SMS], [change SMS], [Interval alarm SMS] and [Total alarm sms] can not be set.

This device supports 2 digital inputs , compatible with wet and dry contacts, sampling frequency 200ms, logic level when wet contacts: 0~0.5V is NC, +3~30V is regarded as NO. Contains 5 uses: "Disable", "NO", "NC", "Counting" and "Change", which can be flexibly combined for monitoring of multiple needs to meet the needs of different applications. The first digital quantity can be used for high-speed pulse counting with a sampling frequency of 1MHz, and the second one supports low-speed pulse counting.

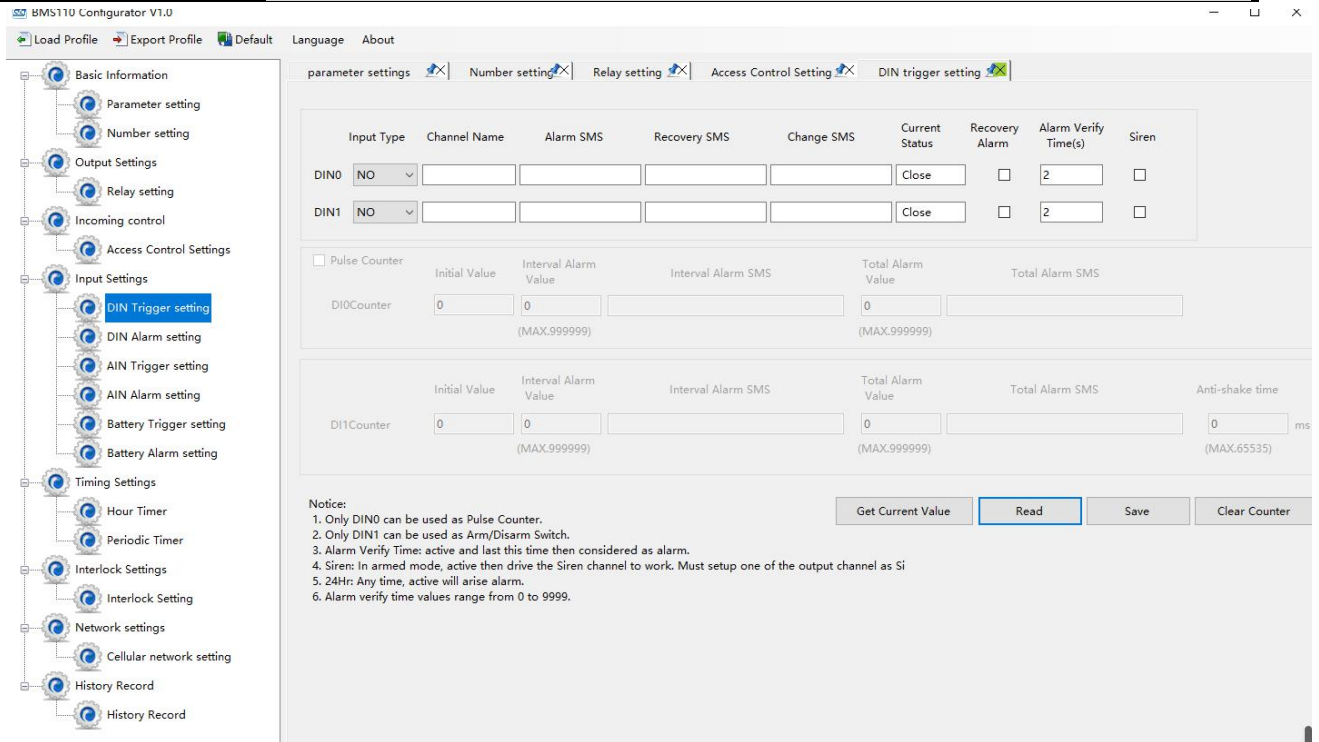

Note:

- 1) Select the corresponding type in the configuration software according to the NO and NC input
- 2) type of the detector. If it is not clear, please Consult the detector manufacturer;
- 2) Please refer to 2.3.4 DI typical wiring diagram for wiring mode.

DI settings @ input settings		
Item	Description	Default
Input type	<ul style="list-style-type: none"> ● Disable: after selection, the digital input will be disabled. ● NO: after selection, the equipment will think that the normal state of the digital input is normally open, and the normally closed state is an abnormal event. ● NC: after selection, the equipment will think that the normal state of the digital input is normally closed, and the normally open state is an abnormal event. ● Change: after selection, the device will think that every change of the digital input state is an abnormal event. ● Counter: after the counter is selected by DI0 ~ 1, the input pulse can be counted. 	
Channel name	User defined channel name, used for channel description when SMS alarm.	null
Alarm SMS	You can customize the content of SMS sent after alarm	empty
Restovery SMS	You can customize the content of SMS sent after alarm recovery	empty



Battery Management Alarm System

BMS100

Change SMS	You can customize the content of SMS sent after displacement alarm	empty
Current value	Current status of digital input	--
Restore alarm	In the deployment or 24-hour attribute, alarm recovery will send the content of recovery alarm SMS.	Not selected
Alarm Verify time	When the alarm is enabled, an alarm will be given if the time exceeds this time, and the unit is seconds.	1
Siren	When arm,will output siren	Not selected

Counter @ DI settings		
Item	Description	Default
Counter	Ticked to enable the counter function	Not selected
Initialvalue	DI0 ~ 1 is used as the initial value of counting.	empty
Interval alarm value	A short message alarm will be generated every time the interval value is counted,	empty
Interval alarm SMS	When the count interval alarm is generated, the content message will be sent to the authority number.	empty
Total alarm value	The count value will be cleared to the starting value automatically	empty
Total alarm sms	When the generation count reaches the maximum value, the content message will be sent to the permission number.	empty
Anti shake time	Unit: MS, the default value is 1, which means that the maximum sampling frequency is 1kHz; when the pulse frequency is low, properly increasing the anti jitter time can improve the accuracy. (pulse sampling frequency = 10000 anti jitter time, such as 1ms corresponding to 1000Hz, 10ms to 100Hz, 100ms to 10Hz, 1000ms to 1Hz)	1

4.6.2 DI alarm setting

Through this page, users can quickly set the characteristics of alarm number after digital input triggers alarm, such as sending short messages, dialing telephone numbers to different authorized personnel, so as to achieve the purpose of directional and rapid alarm of special personnel.

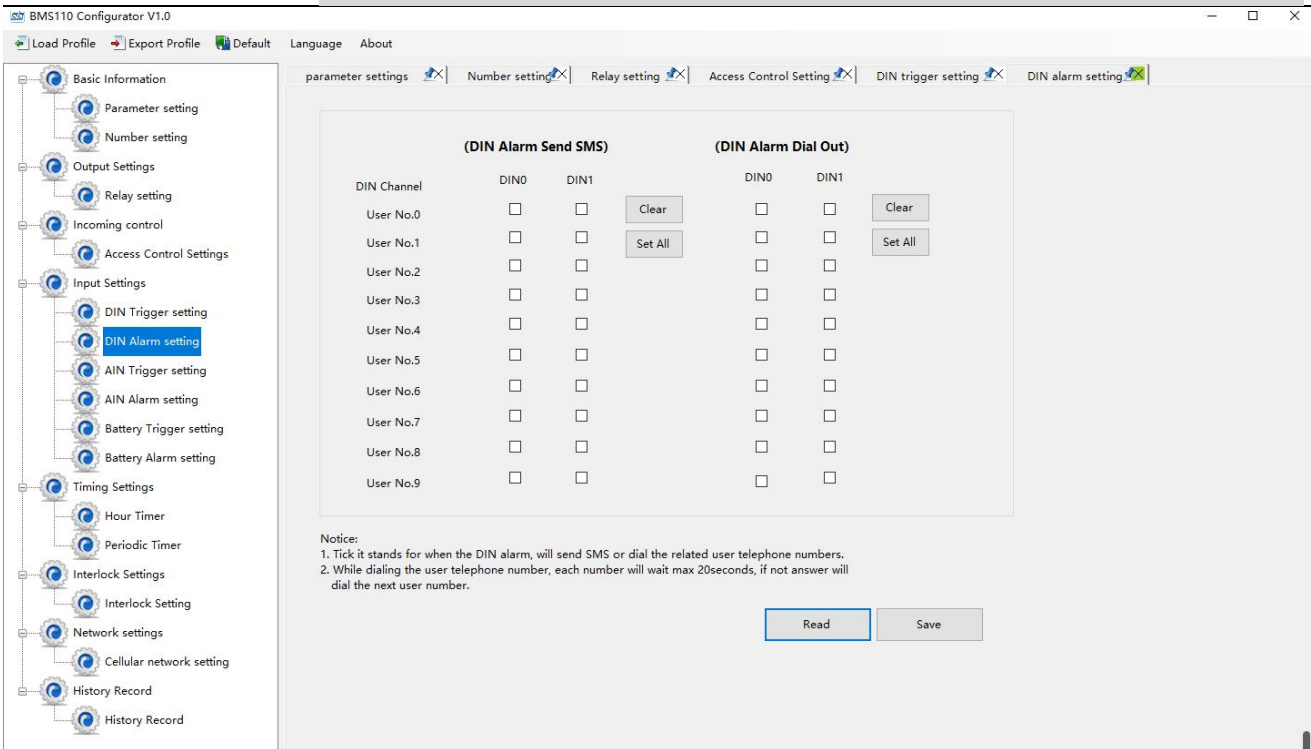

DI alarm settings @ input settings		
Item	Description	Default
DIN channel	Including DI0, DI1	--
DIN alarm send SMS	Indicates that the column number has the ability to receive the number input alarm SMS of the column.	Tick
DIN alarm dial out	Indicates that the column number has the alarm dial for receiving the number input of the column.	Tick

4.6.3 AIN trigger setting

Through this page, users can quickly configure the purpose and parameters of analog input, such as temperature monitoring, current monitoring, voltage monitoring, power factor monitoring, oil level monitoring, etc. Users can set the high and low limit alarm threshold value and recover the alarm according to the needs. When the limit is exceeded or recovered, personalized notification can be set to specific users to realize the purpose of fast warning to the responsible person.

The device supports 2 analog input, 12 bit resolution, 200ms sampling frequency, 0-5V, 0-20mA, 4-20mA output sensor. It can be flexibly combined for measurement and monitoring of various requirements to meet the needs of different applications. Such as three-phase current and voltage monitoring and so on.

Note: the input type of AI requires:

- 1) According to the output type of the transmitter, set the correct Ma and V type on the device dial switch. Please refer to 2.3.1 mode selection and 2.3 AI wiring diagram;
- 2) The same input type should be set in the configuration software;
- 3) For the max and min range, please refer to the transmitter technical specification or consult the transmitter manufacturer.



Battery Management Alarm System BMS100

In addition, the device supports a PT100 input for monitoring the site environment. The temperature measurement range is - 50 ~ 300 ° C.

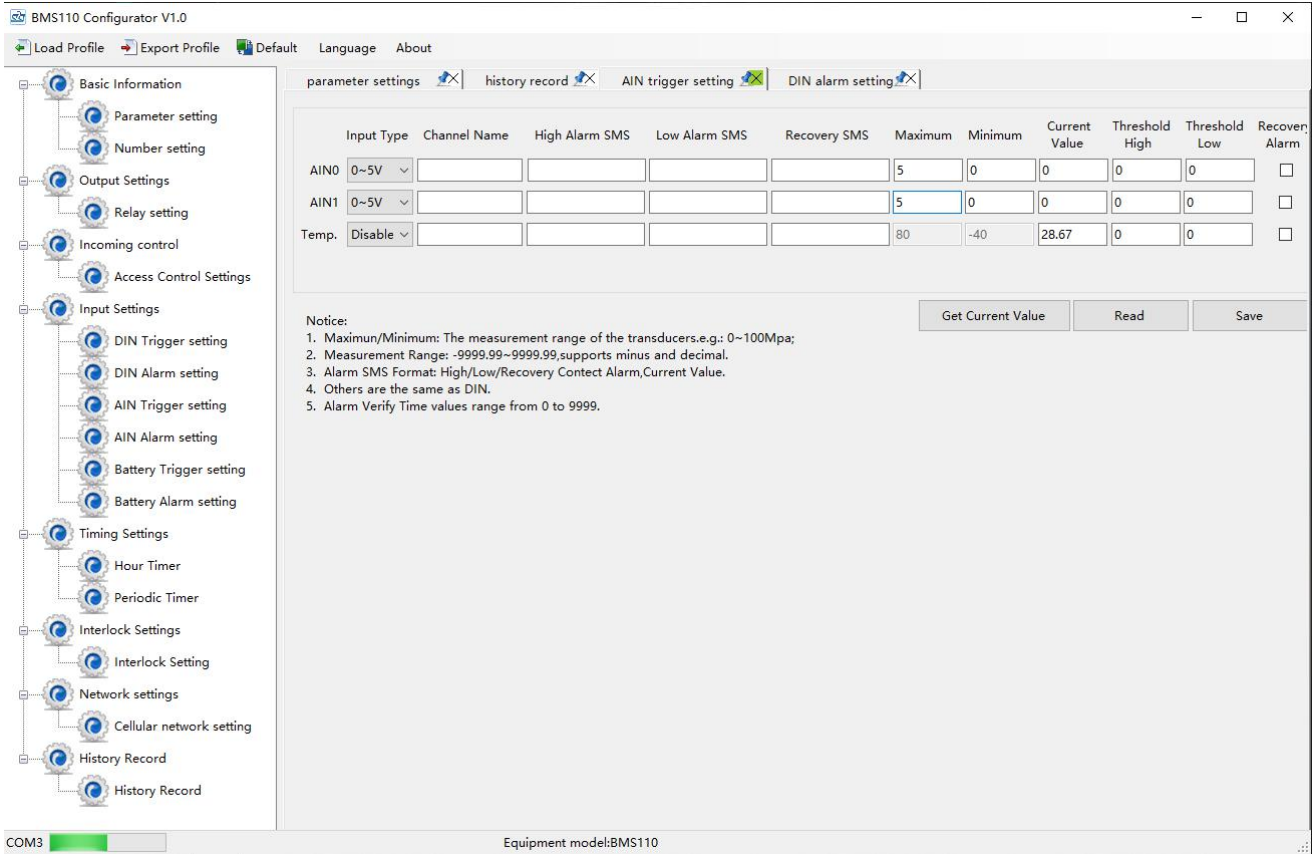

Note: when accessing the cloud platform, the items of [high alarm sms], [low alarm sms], [recover SMS] no need set.

AI trigger settings @ input settings		
Item	Description	Default
Input type	Disable: do not use this channel Enable: use this channel 0 ~ 5V: used to connect sensors with output type of 0 ~ 5V 0 ~ 20mA: used to connect sensors with output type of 0 ~ 20mA 4 ~ 20mA: used to connect sensors with output type of 4 ~ 20mA	Disable
Channel name	User defined channel name, used for channel description when SMS alarm.	empty
High alarm sms	When the current value is higher than the upper limit value, the setting SMS content will be sent to the permission number.	empty
Low alarm sms	When the current value is higher than the upper limit value, the setting SMS content will be sent to the permission number.	empty
Recovery sms	If the recovery alarm is checked, when the current value	empty

	returns to the normal level, the SMS content of the setting will be sent to the authority number	
Maximum	Maximum range of sensor	empty
Minimum	Minimum range of sensor	empty
Current value	Refers to the current real value read out, such as the pressure is xxxpa, or the temperature is XXX °C.	--
Threshold high	When the current value exceeds the upper limit of alarm, an alarm will be triggered;	empty
Threshold low	When the current value is lower than the alarm upper limit value, an alarm will be triggered;	empty
Recovery alarm	When the duty returns to the normal range, the authority number will be informed by SMS.	Not selected
Alarm verify time	In case of alarm, the alarm will only be given if the duration exceeds the set time,	1
Siren	When arm,will output siren	Not selected

4.6.4 AIN alarm setting

Through this page, users can quickly set the characteristics of the alarm number after the analog input triggers the alarm, such as sending short messages, dialing telephone numbers to different authorized personnel, so as to achieve the purpose of directional and rapid alarm for special personnel.

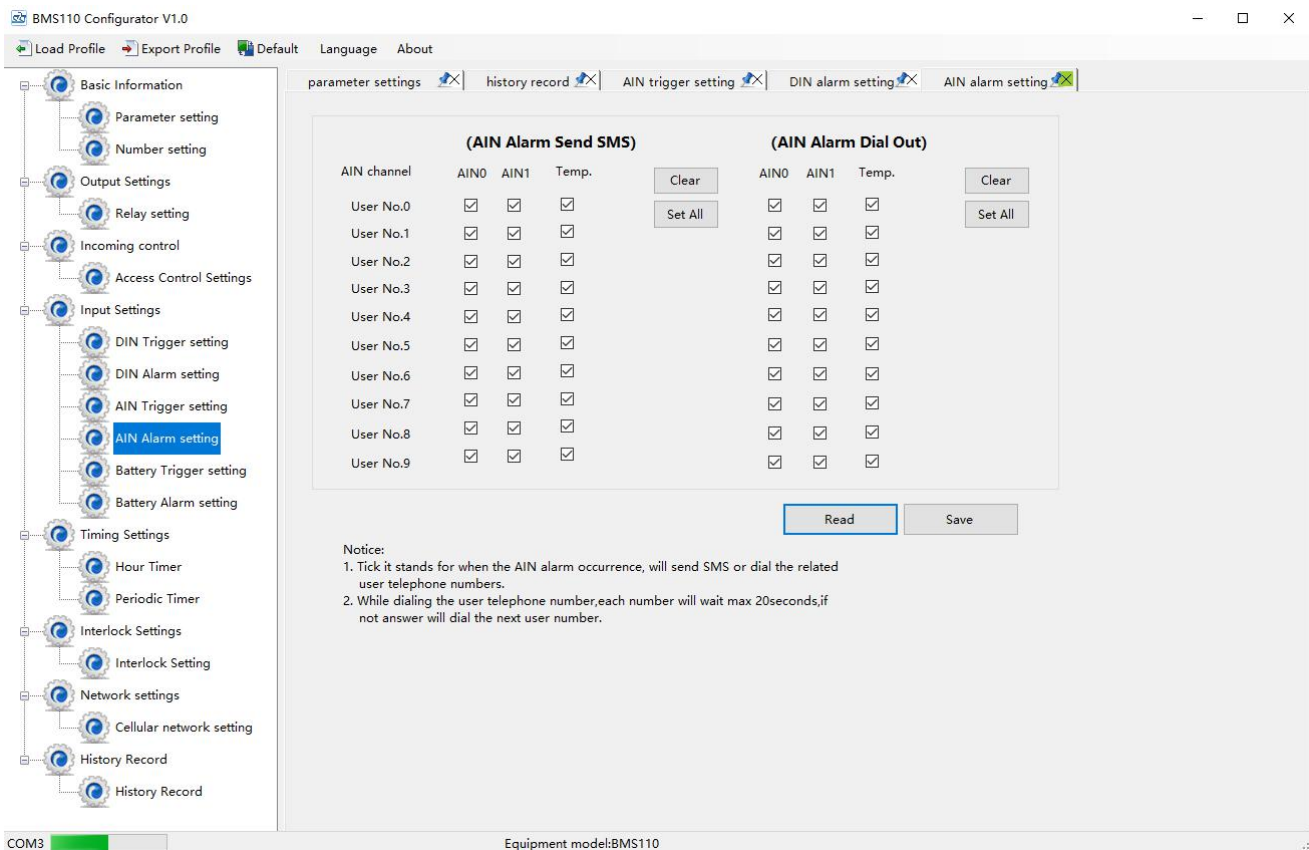

(AIN Alarm Send SMS)

AIN channel	AIN0	AIN1	Temp.
User No.0	<input checked="" type="checkbox"/>	<input checked="" type="checkbox"/>	<input checked="" type="checkbox"/>
User No.1	<input checked="" type="checkbox"/>	<input checked="" type="checkbox"/>	<input checked="" type="checkbox"/>
User No.2	<input checked="" type="checkbox"/>	<input checked="" type="checkbox"/>	<input checked="" type="checkbox"/>
User No.3	<input checked="" type="checkbox"/>	<input checked="" type="checkbox"/>	<input checked="" type="checkbox"/>
User No.4	<input checked="" type="checkbox"/>	<input checked="" type="checkbox"/>	<input checked="" type="checkbox"/>
User No.5	<input checked="" type="checkbox"/>	<input checked="" type="checkbox"/>	<input checked="" type="checkbox"/>
User No.6	<input checked="" type="checkbox"/>	<input checked="" type="checkbox"/>	<input checked="" type="checkbox"/>
User No.7	<input checked="" type="checkbox"/>	<input checked="" type="checkbox"/>	<input checked="" type="checkbox"/>
User No.8	<input checked="" type="checkbox"/>	<input checked="" type="checkbox"/>	<input checked="" type="checkbox"/>
User No.9	<input checked="" type="checkbox"/>	<input checked="" type="checkbox"/>	<input checked="" type="checkbox"/>

(AIN Alarm Dial Out)

AIN channel	AIN0	AIN1	Temp.
User No.0	<input checked="" type="checkbox"/>	<input checked="" type="checkbox"/>	<input checked="" type="checkbox"/>
User No.1	<input checked="" type="checkbox"/>	<input checked="" type="checkbox"/>	<input checked="" type="checkbox"/>
User No.2	<input checked="" type="checkbox"/>	<input checked="" type="checkbox"/>	<input checked="" type="checkbox"/>
User No.3	<input checked="" type="checkbox"/>	<input checked="" type="checkbox"/>	<input checked="" type="checkbox"/>
User No.4	<input checked="" type="checkbox"/>	<input checked="" type="checkbox"/>	<input checked="" type="checkbox"/>
User No.5	<input checked="" type="checkbox"/>	<input checked="" type="checkbox"/>	<input checked="" type="checkbox"/>
User No.6	<input checked="" type="checkbox"/>	<input checked="" type="checkbox"/>	<input checked="" type="checkbox"/>
User No.7	<input checked="" type="checkbox"/>	<input checked="" type="checkbox"/>	<input checked="" type="checkbox"/>
User No.8	<input checked="" type="checkbox"/>	<input checked="" type="checkbox"/>	<input checked="" type="checkbox"/>
User No.9	<input checked="" type="checkbox"/>	<input checked="" type="checkbox"/>	<input checked="" type="checkbox"/>

Notice:
 1. Tick it stands for when the AIN alarm occurrence, will send SMS or dial the related user telephone numbers.
 2. While dialing the user telephone number,each number will wait max 20seconds;if not answer will dial the next user number.

AI alarm @ input settings



Battery Management Alarm System BMS100

Item	Description	Default
Analog channel	Including AI0, AI1,temperature	--
AI alarm send sms	It indicates that the column number has the ability to receive the alarm message of analog input of the column.	Check
AI alarm dial out	Indicates that the number of the column has received the analog alarm dialing of the column.	Check

4.6.5 Battery trigger setting

This device supports 4 channels 0~15VDC battery input.

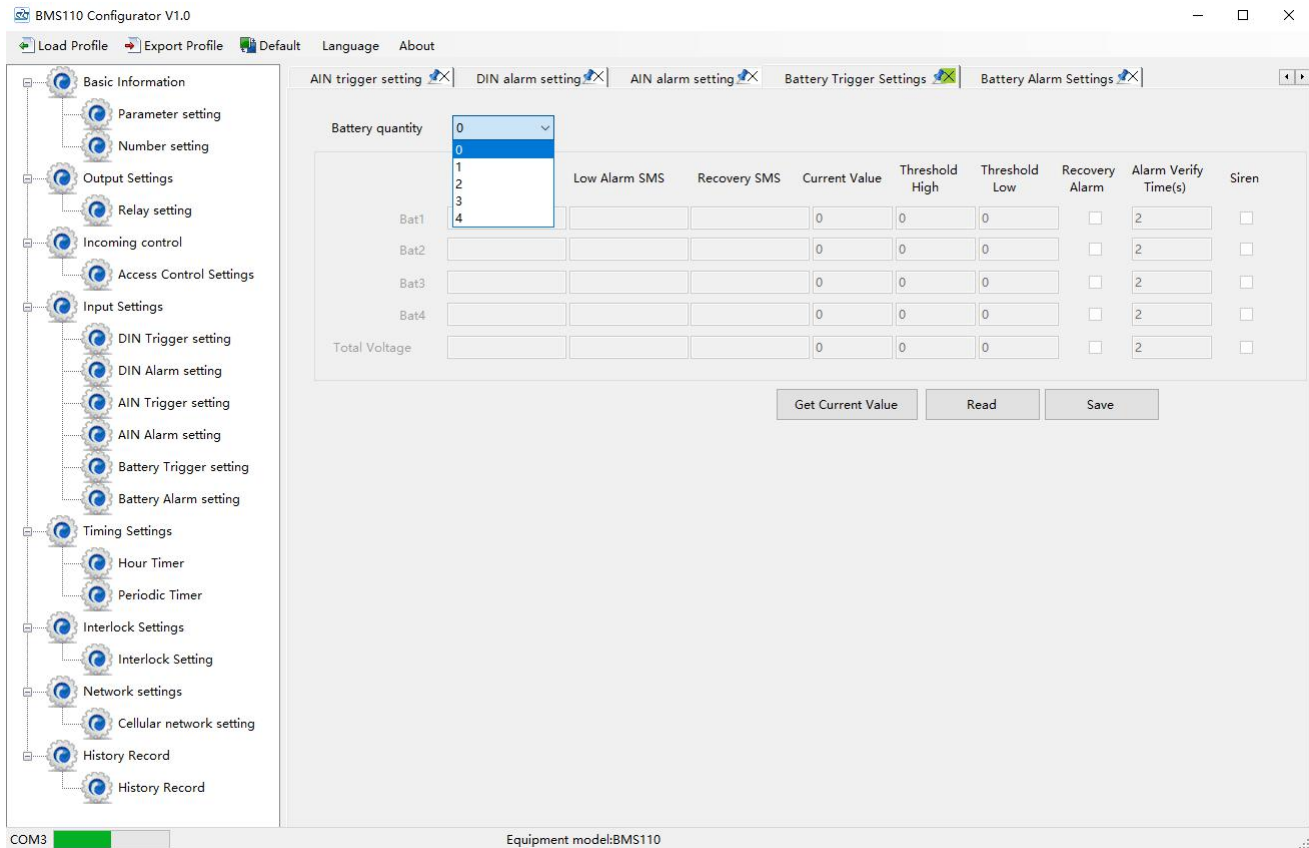

Note: when accessing the cloud platform, the items of [high alarm sms], [low alarm sms], [recover SMS] no need set.

Battery trigger setting@input setting		
Item	Description	Default
Battery quantity	0~4 can be set, according to the number of connected batteries	0
High alarm sms	When the current value is higher than the upper limit value, the setting SMS content will be sent to the permission number.	empty
Low alarm sms	When the current value is higher than the upper limit value, the setting SMS content will be sent to the permission number.	empty
Recovery sms	If the recovery alarm is checked, when the current	empty

	value returns to the normal level, the SMS content of the setting will be sent to the authority number	
Current value	Refers to the current real value read out, such as the pressure is xxxpa, or the temperature is XXX °C.	--
Threshold high	When the current value exceeds the upper limit of alarm, an alarm will be triggered;	empty
Threshold low	When the current value is lower than the alarm upper limit value, an alarm will be triggered;	empty
Recovery alarm	When the duty returns to the normal range, the authority number will be informed by SMS.	Not selected
Alarm verify time	In case of alarm, the alarm will only be given if the duration exceeds the set time,	1
Siren	When relay 1 is output as alarm signal and connected with alarm signal, in case of alarm, relay 1 will be regarded as connected to alarm switch and perform closing action.	Not selected

4.6.6 Battery alarm setting

Through this page, users can quickly set the characteristics of the alarm number after the analog input triggers the alarm, such as sending short messages, dialing telephone numbers to different authorized personnel, so as to achieve the purpose of directional and rapid alarm for special personnel.

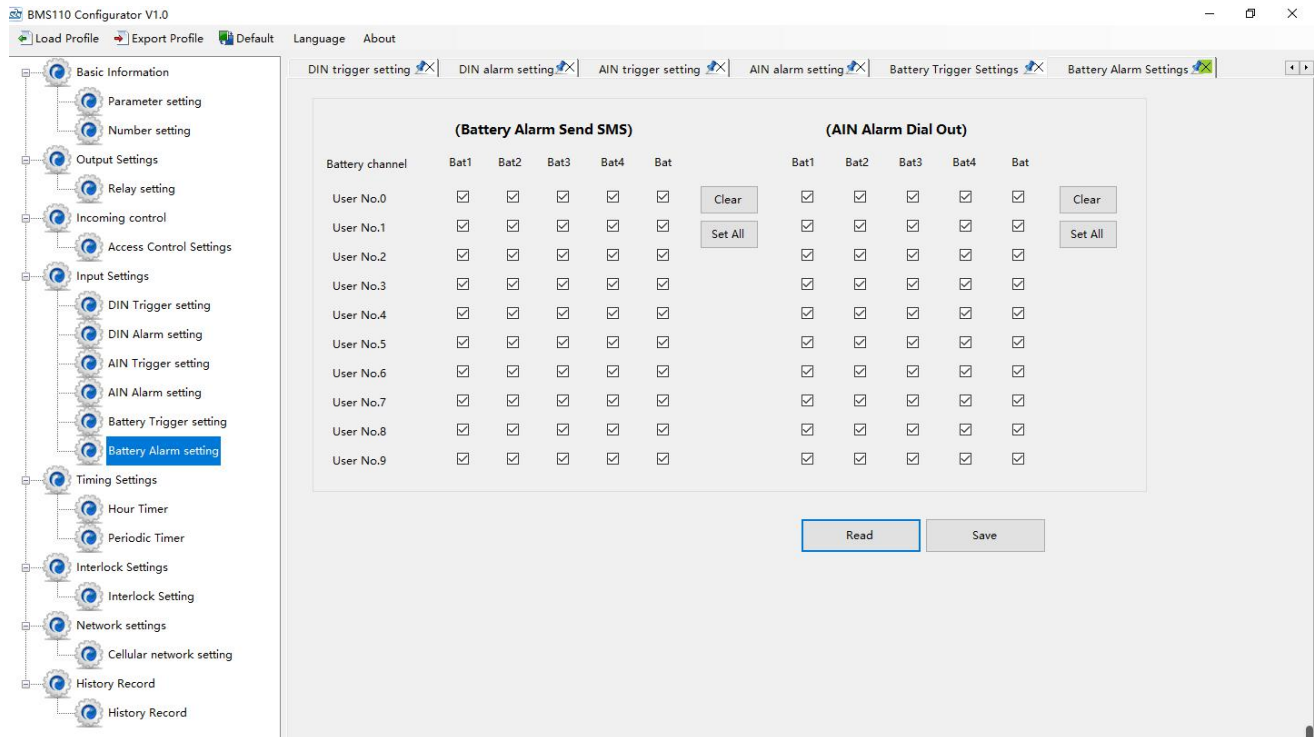

Battery alarm setting@ input settings		
Item	Description	Default
Battery channel	Including Bat1, Bat2,Bat3,Bat4,total voltage	--
Battery alarm	It indicates that the column number has the ability to	Check



send sms	receive the alarm message of this battery.	
Battery alarm dial out	Indicates that the number of the column has received the battery alarm dialing of the column.	Check

4.7 Timer Setting

Through this page, users can quickly set the device to automatically execute certain actions at a preset time, so as to achieve the purpose of automatic control and automatic execution of actions according to the predetermined time, which can effectively reduce human participation and greatly improve efficiency. For example, start water pump regularly, discharge sewage regularly, start exhaust fan regularly, timing switch equipment and so on.

In addition, the device provides a variety of timing functions, which can meet the application needs of most places. For example, it can execute some action at a certain time every day and every week, and from a certain preset time point, interval a certain preset time, and then perform a certain action periodically. A total of 10 timing events can be set.

4.7.1 Hour timer

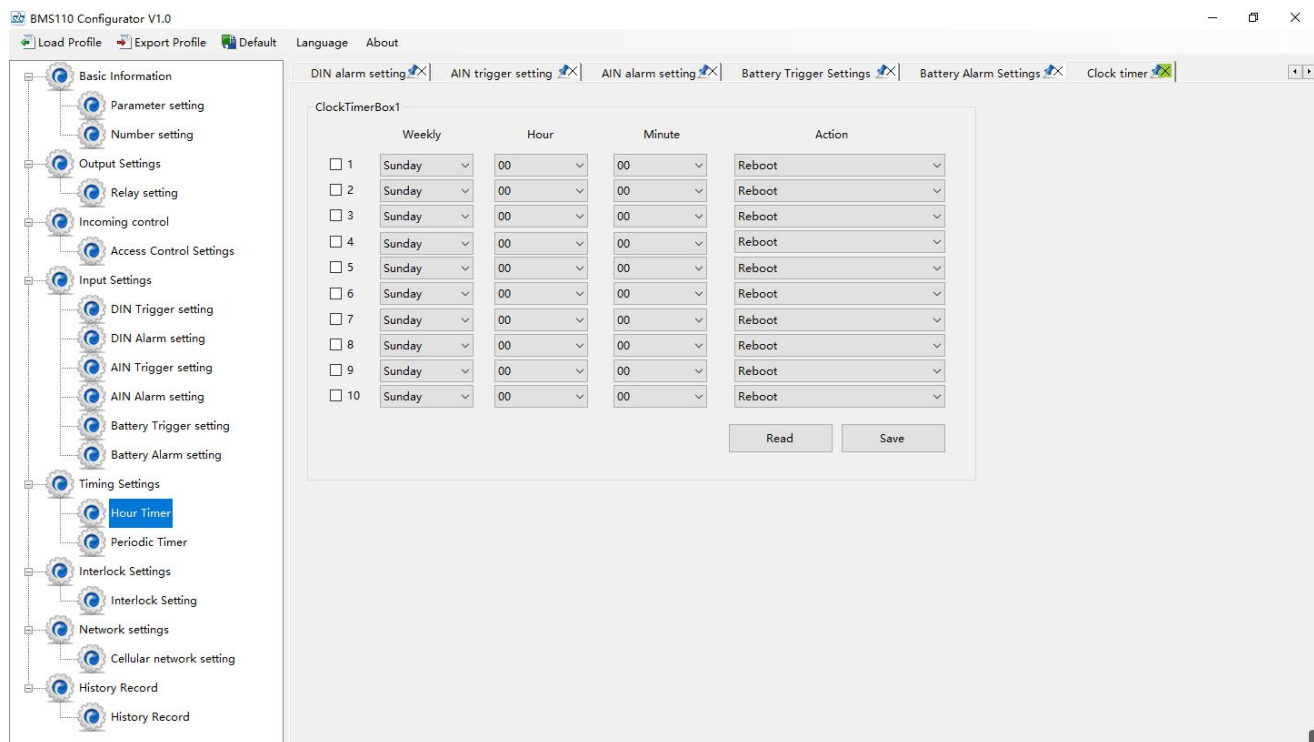

Hour Timer		
Item	Description	Default
1-10	For timers 1-10	Not selected
Weekly	Set up Monday to Sunday or every day.	--
Hour	Specific hours set	--
Minute	Set the specific minutes	--
Action	The specific action to be executed at the set time.	--

4.7.2 Periodic timer

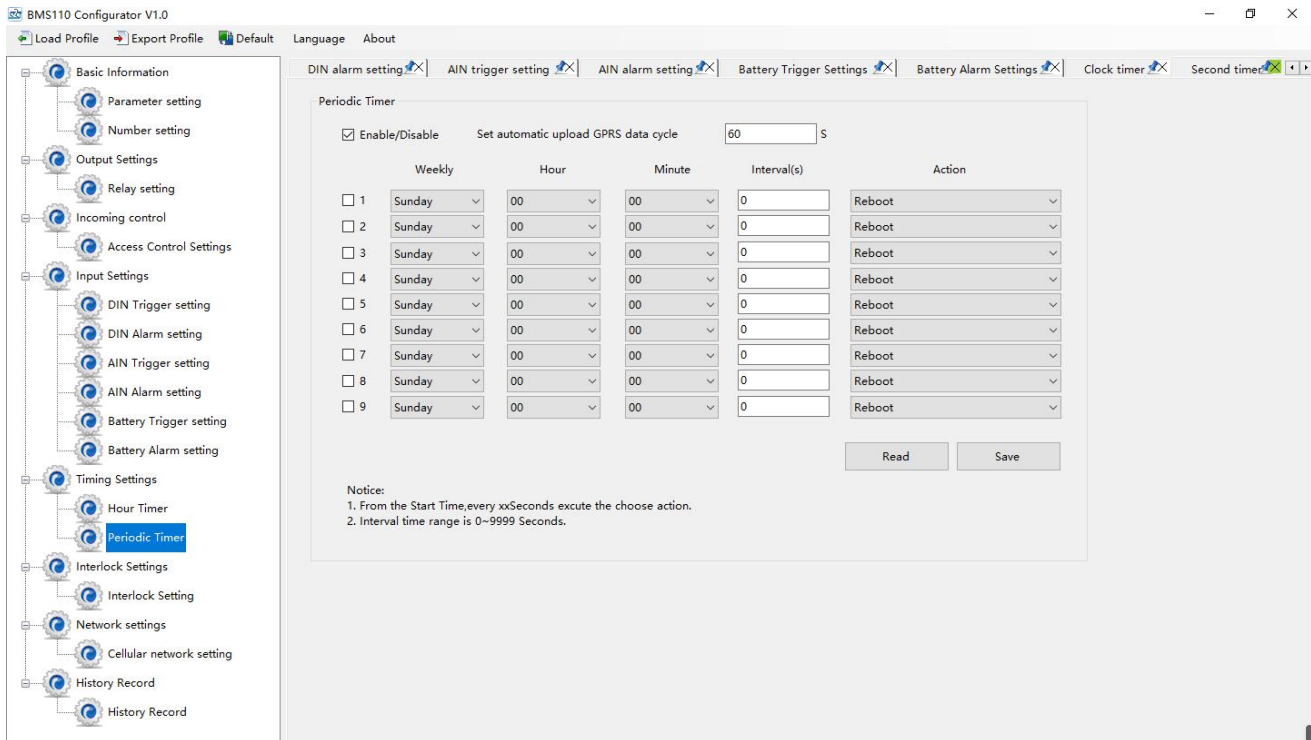

Periodic timer		
Item	Description	Default
Periodically auto upload GPRS data	When the GPRS/3G/4G data network transmission protocol is the King Pigeon IoT RTU protocol, the GPRS/3G/4G data reporting cycle time is enabled by default, and the unit: minutes.	5
1-10	For timers 1-10	Not selected
Weekly	Set up Monday to Sunday or every day.	--
Hour	Specific hours set	--
Minute	Set the specific minutes	--
Action	Device restart, automatic SMS report, pulse count reset, save historical data	--

4.8 Interlock setting

Through this page, users can quickly set up to 40 kinds of automatic logic control functions, which can meet the automation control needs of most applications. It is triggered automatically according to preset conditions without human intervention, the device automatically performs predetermined actions, and will notify the user by SMS or network data. On the one hand, it saves time and reduces losses, on the other hand it improves work efficiency. For example: it can be set to automatically start the exhaust air cooling device when the temperature is too high, and automatically shut down the exhaust air cooling device when the temperature is restored, or start the diesel generator when the current and voltage are low, and when the current and voltage are high, Stop the diesel generator, or turn off the water pump when the water pressure is high, start the water pump when the water pressure is low, and so on.



Battery Management Alarm System BMS100

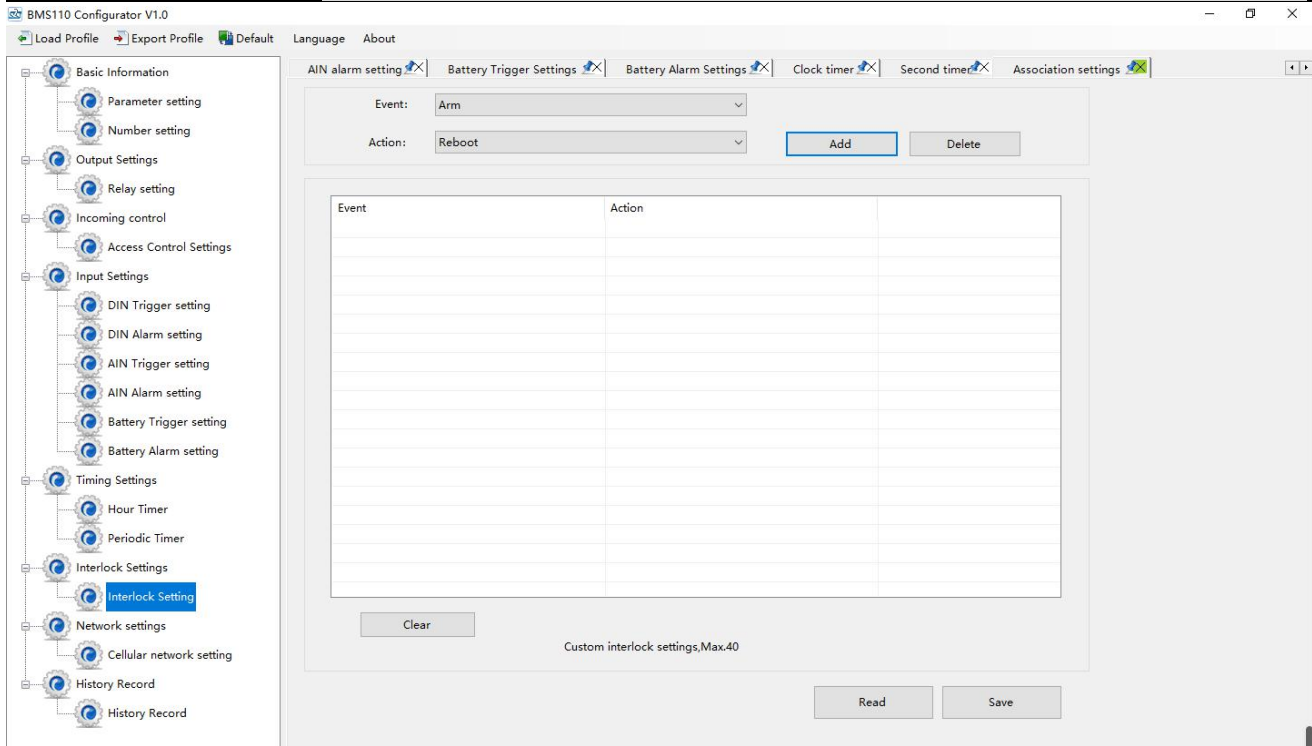

Interlock settings		
Item	Description	Default
Event	It includes: "Arm","Disarm" "DI0-1 trigger", "DI0-1 recovery", "DI0-1 pulse interval alarm", "DI0-1 pulse total number alarm", "AI0-1 high alarm", "AI0-1 low alarm", "AI0-1 recovery", "temperature high alarm", "temperature Low alarm", "temperature alarm recovery", "humidity high alarm", "humidity low alarm", "humidity alarm recovery","Battery 1-4 trigger", "Battery 1-4 recovery", "Battery 1-4 high alarm", "Battery 1-4 low alarm", "Total voltage high alarm ", "Total voltage low alarm ", "Total voltage recovery"	--
Action	It includes: "Reboot", "DO0 close", "DO0 open","Arm", "Disarm", "Opendoor", "Siren".	--
Add	Click to add the selected settings	--
Delete	Click to delete the selected settings	--



4.9 Network setting

Note:

If the device is connected to the KingPigeon cloud platform, please follow the following steps:

- 1) Click to connect [King Pigeon cloud 2.0] or [King Pigeon cloud 3.0]; King Pigeon cloud 2.0 Login URL: www.my-m2m.com; King Pigeon cloud 3.0 Login URL: <http://kpiiot.com>
- 2) If it is connected to [King Pigeon cloud 2.0], please contact the sales representative for the [login message], and fill in the corresponding box in the Login message;
- 3) If it is connected to [King Pigeon cloud 3.0], please contact the sales representative for the [login message], and fill in the corresponding box.
- 4) Click write to complete the parameter settings for accessing the cloud platform. Then turn off the device, turn the [set run] switch to the [run] side, and then turn on the device again to complete the device access cloud platform setting operation. There is no need to read other contents in this section.
- 5) Read the "Access King Pigeon cloud user manual" and operate on the cloud platform

This page is used to configure the function parameters of the device accessing the Internet. Rich automatic handshake registration package, custom heartbeat package, offline mechanism and other functions make the device quickly compatible with a variety of third-party PC systems and cloud platforms. The device can communicate with the monitoring software or cloud platform in the Internet through the GPRS/3G/4G wireless cellular network. It includes the following ways:

1) Modbus RTU protocol: Modbus RTU over TCP, the Modbus RTU protocol is transmitted over the TCP link to realize the two-way communication between the equipment and the upper computer, such as access KPIIOT V3.0 Cloud platform; Domain Name: modbusrtu.kpiiot.com, port number: 4000.

2) Modbus TCP protocol: before and after the standard Modbus RTU protocol message, the header and tail of TCP are encapsulated to realize the two-way communication between the device and the upper computer, such as access KPIIOT V3.0 Cloud platform; Domain Name: modbusrtu.kpiiot.com, port number: 4000.

3) King pigeon IOT RTU protocol: transmit the King pigeon IOT RTU protocol over the TCP link to realize the two-way communication between the equipment and the upper computer. The advantage of this communication protocol is that when the equipment is abnormal, it can send data to the upper computer immediately, instead of waiting for the upper computer to ask. It avoids the defects of the first two protocols, such as access WWW.RTU-M2M.COM cloud platform. (The server is currently fully loaded and no new equipment is involved)

4) Through the mqtt protocol: Running the mqtt protocol on the TCP link to realize the two-way communication between the device and the host computer. The advantage of this communication protocol is that when the network is offline, the data will be cached, and when the network recovers, it will be released to realize the supplementary transmission of historical data. For example, access to www.my-m2m.com cloud platform; Domain Name: mqtt.dtuip.com, port number: 1883.



Battery Management Alarm System BMS100

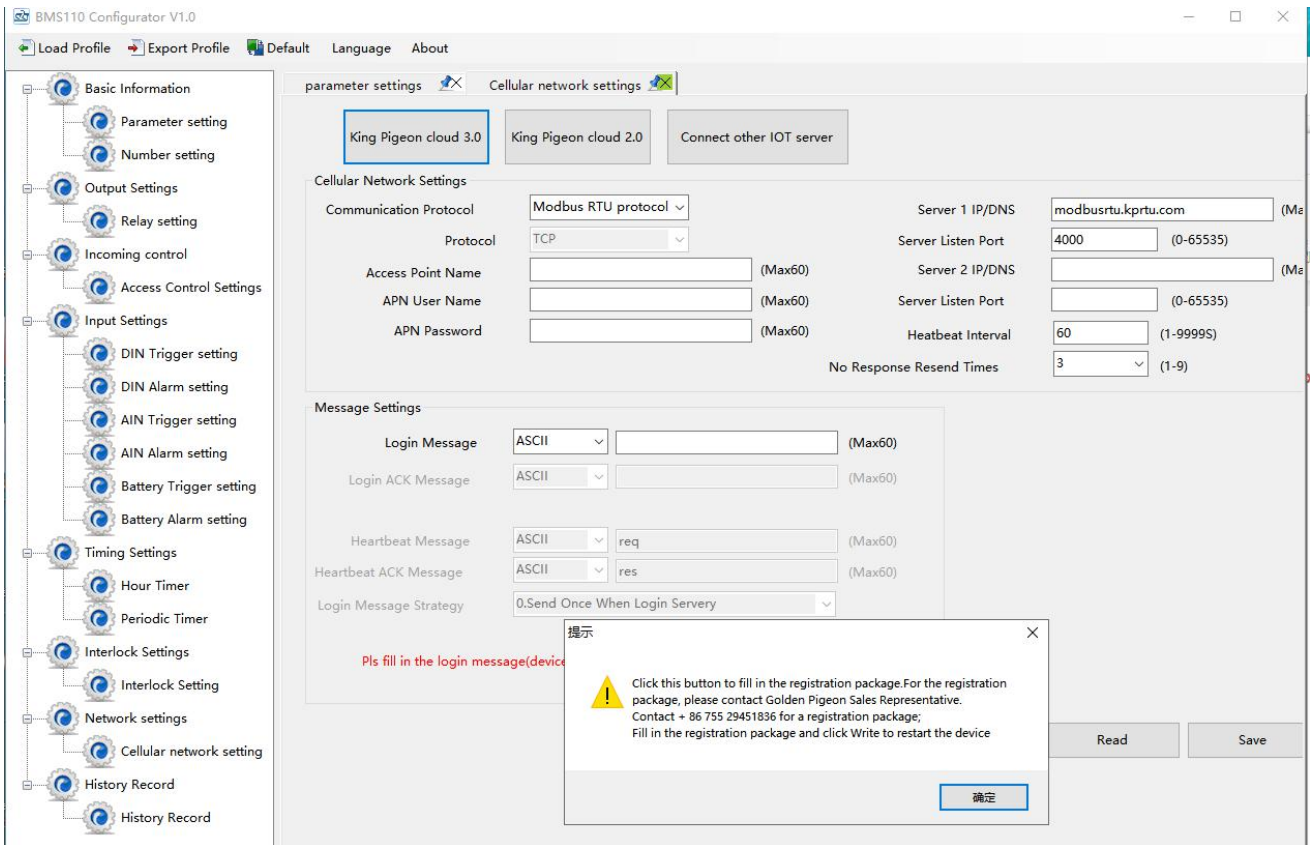

Communication protocol @ network settings		
Item	Description	Default
Communication protocol	Options are "disable", "Modbus RTU Protocol", "IOT RTU Protocol", "Modbus TCP Protocol", "mqtt Protocol".	Disable
Protocol	Optional TCP	TCP
Access point name	APN access point of mobile operator	empty
User name	Internet user name of mobile operator	empty
Password	Access password of mobile operator	empty

Server settings @ network settings		
Item	Description	Default
Server 1 IP/DNS	Domain name or IP of target server 1	modbusrtu.kpirtu.com
Server listen port	Target server port 1	4000
Server 2 IP/DNS	Domain name or IP of target server 2	empty
Server listen port	Target server port 2	empty
Heartbeat interval	Heartbeat packet sending interval, unit: seconds.	300
No Response Resend Times	The number of response packets will be re registered and no response packets will be sent.	3
Server connection strategy	Select "prefer server 1". When server 1 fails to connect, it will automatically connect to server 2	Prefer server 1



Registration package strategy @ network settings		
Item	Description	Default
Login message	It is the registered handshake protocol package on the server side	IMEI+0
Login ACK Message	Once set, device need response within 10 seconds after device send login message, otherwise it will continue send login message according to "Reconnection Times" ,still not response will offline once time, then try to reconnect, according to "Server Offline 3 Times, Device Reconnection Time".	empty
Heartbeat message	After setting, the device will send heartbeat packets according to the heartbeat packet time.	empty
Heartbeat ACK message	Once set, device need response within 6 seconds after device send heartbeat message, otherwise it will continue send login message according to "Reconnection Times" ,still not response will offline once time, then try to reconnect, according to "Server Offline 3 Times, Device Reconnection Time".	empty
Login Message Strategy	Include options: "send once when logging in", "before adding each packet of data", "include both of the above".Send once when logging in: it means that after the TCP link is established, the registration packet will be sent once, and it will not be sent again; before adding each packet of data, it means that after establishing the TCP link, it will not be sent, and when there is data transmission, the registration packet will be added before each header; both of the above two items include: the first two items are carried out at the same time.	Send once on login

MQTT settings @ network settings		
Item	Description	Default
Subscribe topic	The topic that the device subscribes to when it receives control data	empty
Publish topic	Topic when the device publishes information	empty
Mqtt client ID	Serial number of the device, unique identification	empty
Mqtt user name	The account of the device to publish the theme on the proxy server	empty
Mqtt password	The device publishes the password for the subject at the proxy server	empty
Automatic data	The time interval for the device to upload data	60 seconds

upload cycle	regularly, with a maximum of 10 seconds	
Mqtt data retransmission	When enabled, the historical cache data during network disconnection will be retransmitted when the network is restored	Disable

4.10 Historical record

The device is built-in 2M EEPROM, which is used to store the alarm record and history record of the device. If you need to record the history of the device, you need to set the interval time for saving the history record in the [Periodic timer] page. The alarm record does not need to be set separately, and the device will automatically save it.

The device will automatically manage the historical records. When there is no available space in the memory, it will automatically delete the previous data and retain the latest half of the historical data. In addition, users can export the data to the computer for permanent storage. The details are as follows:

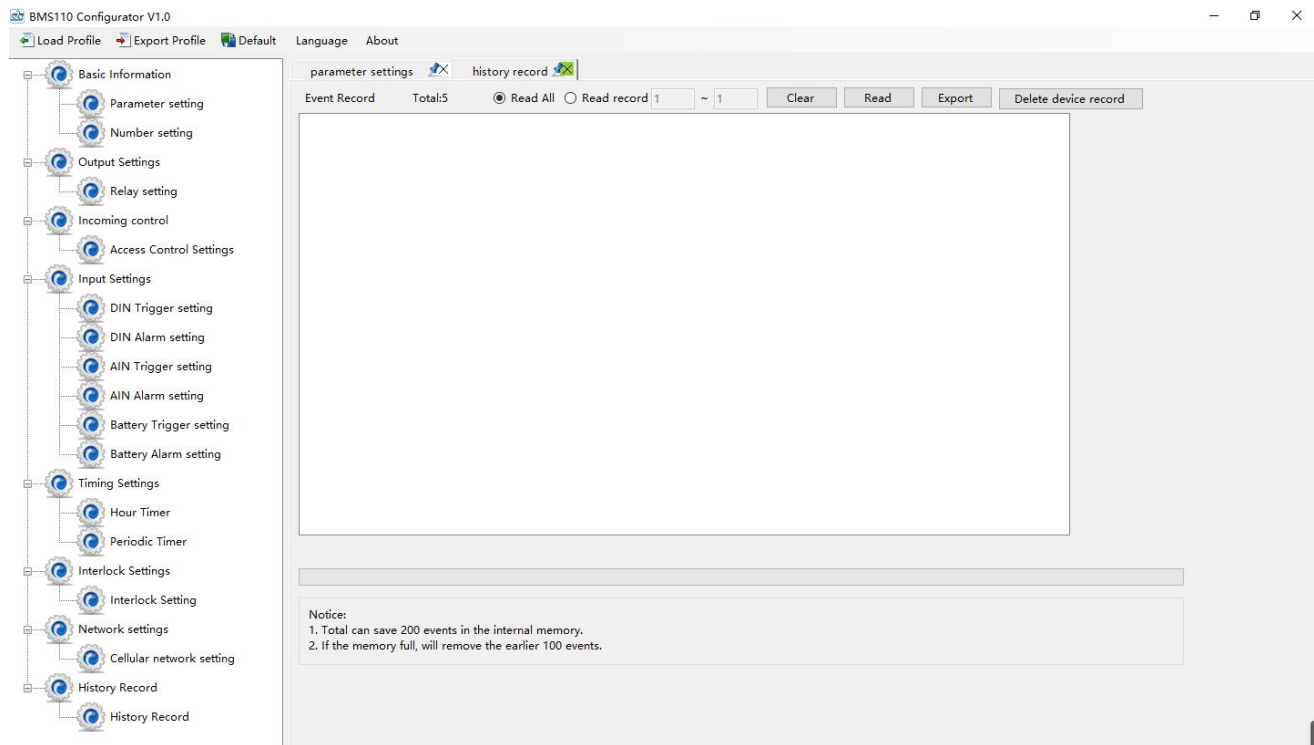

Historical record		
Item	Description	Default
Total	All records	--
Read all	Check to read all records in the device	Tick
Read record	After ticked, you can customize the filter record	Not selected
Clear	That is to clear the screen, first clear the display on the screen.	empty
Read	Read history	empty
Save as CSV	Click this button to export to CSV format file for analysis and view.	--

Delete device records	Click this button will clear the device history data, please use it with caution!	--
-----------------------	---	----

4.11 System

The export and import function can quickly configure the same parameters for multiple devices. Restoring the factory function will restore the equipment to the factory settings.

4.11.1 Export configuration file

Click the "export configuration file" button at the top left of the page (as shown in the figure below), then select the path and enter the file name.

This function is convenient for users to save the configuration parameters of the device and configure multiple devices in batch.

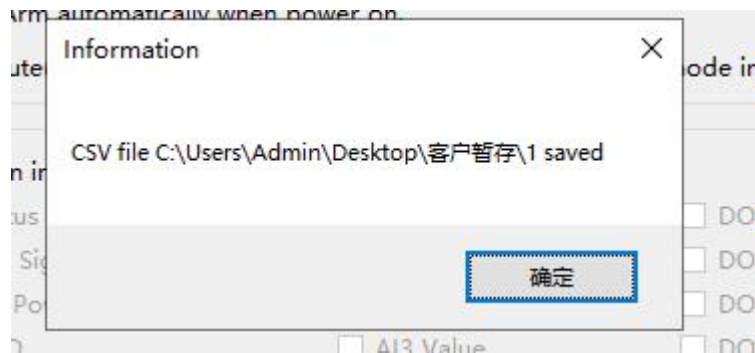
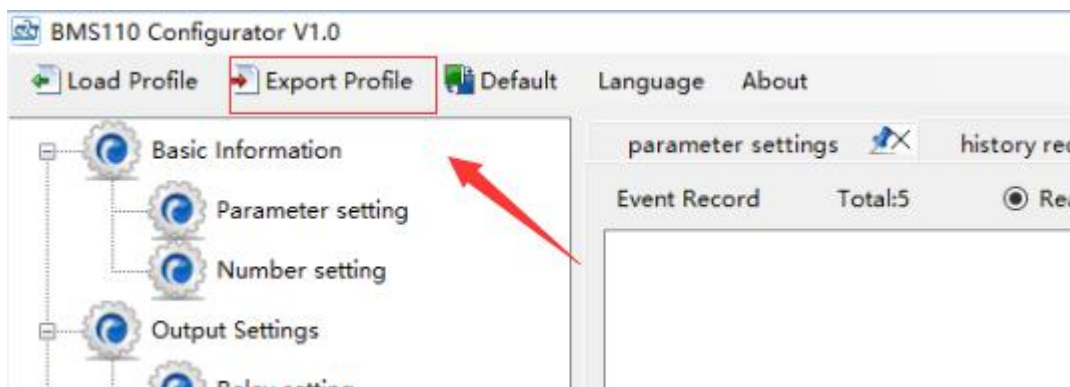

4.11.2 Load Configure File

Click the load profile button at the top left of the page (as shown in the following figure), and then select the file to load.



After a while, you will see the window "loading configuration information succeeded".

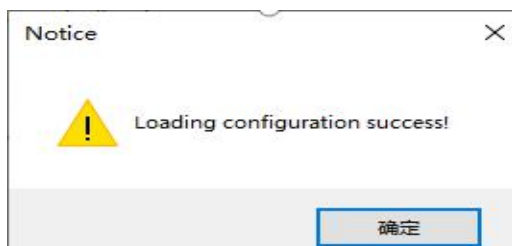

4.11.3 Default

When the device is in power on state, connect the computer configuration software, and reset it through the restore factory settings button of the configuration software. This function will restore all parameters of the device to the factory default initial values. If you forget to set the password, please contact King Pigeon Hi-Tech. Co., Ltd., website www.iot-solution.com.

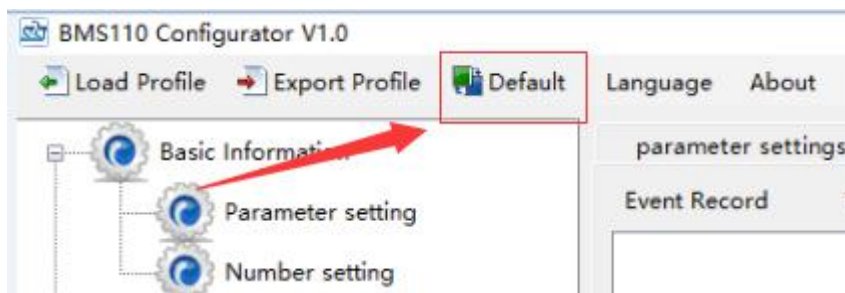

5. SMS Function

1. The default password of the host computer is 1234, which can edit SMS instructions to modify the password to ensure the safety of use;
2. The "password" in the SMS instruction refers to the device password, such as 1234, which can be input directly;
3. The "+" sign in the SMS instruction is not used as the content of SMS. Please do not add any spaces or other characters;
4. SMS instructions must distinguish between capital letters, such as "PWD" instead of "pWd";
5. If the password is input correctly and the command is wrong, the host will return a message: "the command format is wrong, please confirm!" at this time, please check whether the Chinese and English input method or case is correct;
6. If the password is wrong, no information will be returned;
7. The host will return the confirmation message after receiving the SMS instruction. If there is no return message, please check whether the password is correct and whether the signal is normal.

6. Communication protocol

The device supports the access to the server or SCADA or cloud platform in the Internet through the gprs/3g/4g wireless cellular network. Modbus RTU over TCP protocol, Modbus TCP protocol and Golden Pigeon RTU protocol. Users can quickly connect the device to the third-party cloud platform or server.

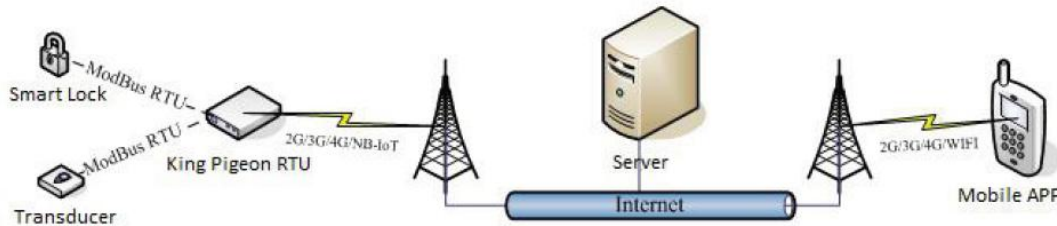

Device network topology

6.1 King Pigeon IoT RTU Protocol

If the user needs the device to actively send alarm data when it detects an abnormality, or the device actively sends data to the server periodically, this communication protocol can be selected. In the [Communication Protocol] on the [Network Settings] page, you must select [IoT RTU Protocol] or [Defined Protocol], [Connection Mode]: [TCP], and set the domain name or IP and port. Other parameters can be set according to the needs of the server. For the detailed definition and explanation of "KingPigeon IoT RTU Protocol", please refer to "KingPigeon IoT RTU Protocol". At present, the mainstream protocols are MQTT, Modbus RTU and other protocols, and the King Pigeon IoT RTU protocol is generally not used.

6.2 Modbus TCP protocol

Device can connect to server or cloud to build TCP connection automatically via GPRS/3G/4G networks. After building TCP connection, server or SCADA or cloud can send Modbus TCP command to device for Modbus TCP communication.

6.3 Modbus RTU over TCP protocol

After device switched on, automatically connect to server or cloud to build TCP connection via GPRS/3G/4G networks. Users can set handshake protocol, login message, heartbeat or other parameter according to cloud server. After TCP connection, server or SCADA or cloud can send Modbus RTU command to device, to build Modbus RTU networks which based on TCP connection.

6.4 MQTT protocol

This device supports standard mqtt protocol and Modbus RTU to mqtt, which is convenient to access the platform. Please check the relevant information Appendix D Application of mqtt

7. Common Application examples

This section introduces several common applications for users' reference, so as to quickly complete the product configuration and installation.

7.1 Quick verification device

1. Turn on the device, run the configuration software, select the port and enter the password to log in. In the basic information page, click "[Read Computer Time]-[Write RTU Time]" to complete the device time setting. As shown below:

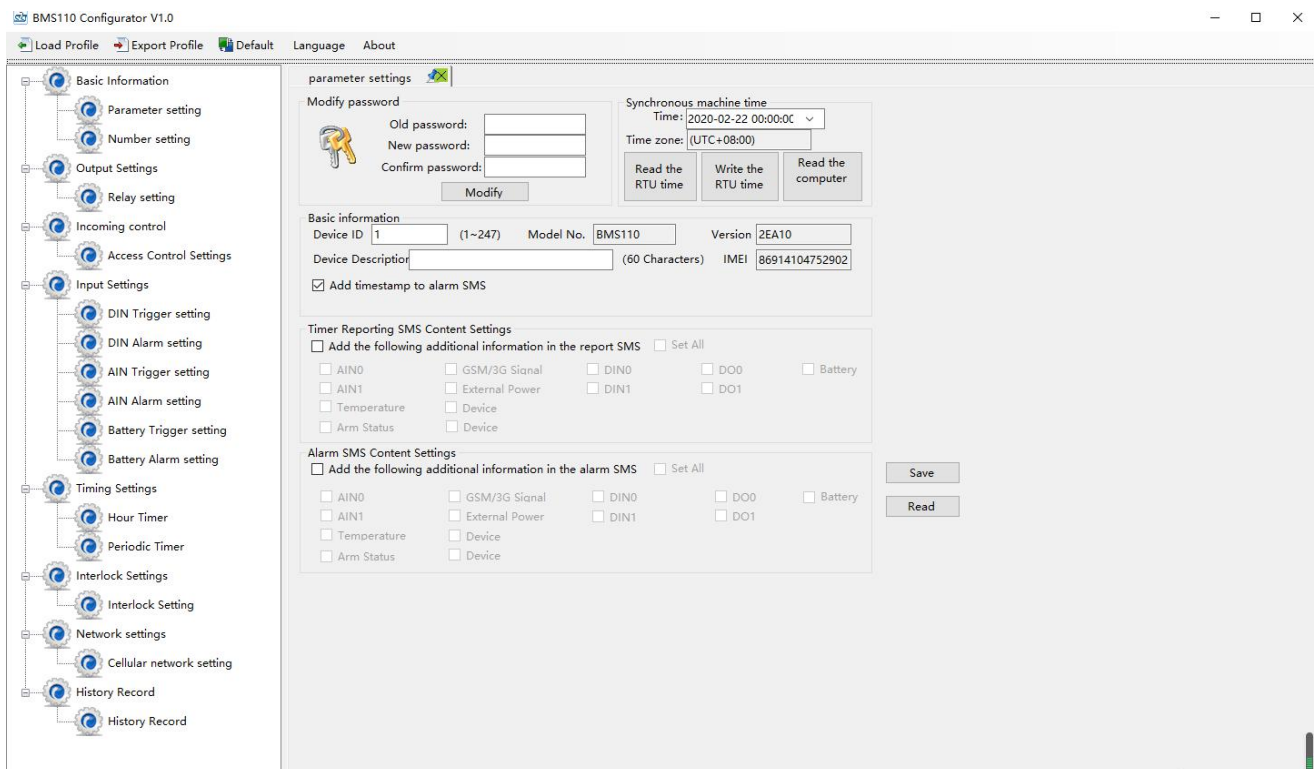

2. On the [Number Settings] page, enter the mobile phone number used to receive the alarm, and then check the corresponding options. For example, if you want to receive text messages from the device startup, external power failure, and external power recovery, then check the startup, power failure, and Recover three incoming calls. Then click the [Write] button on the lower side. As shown below:

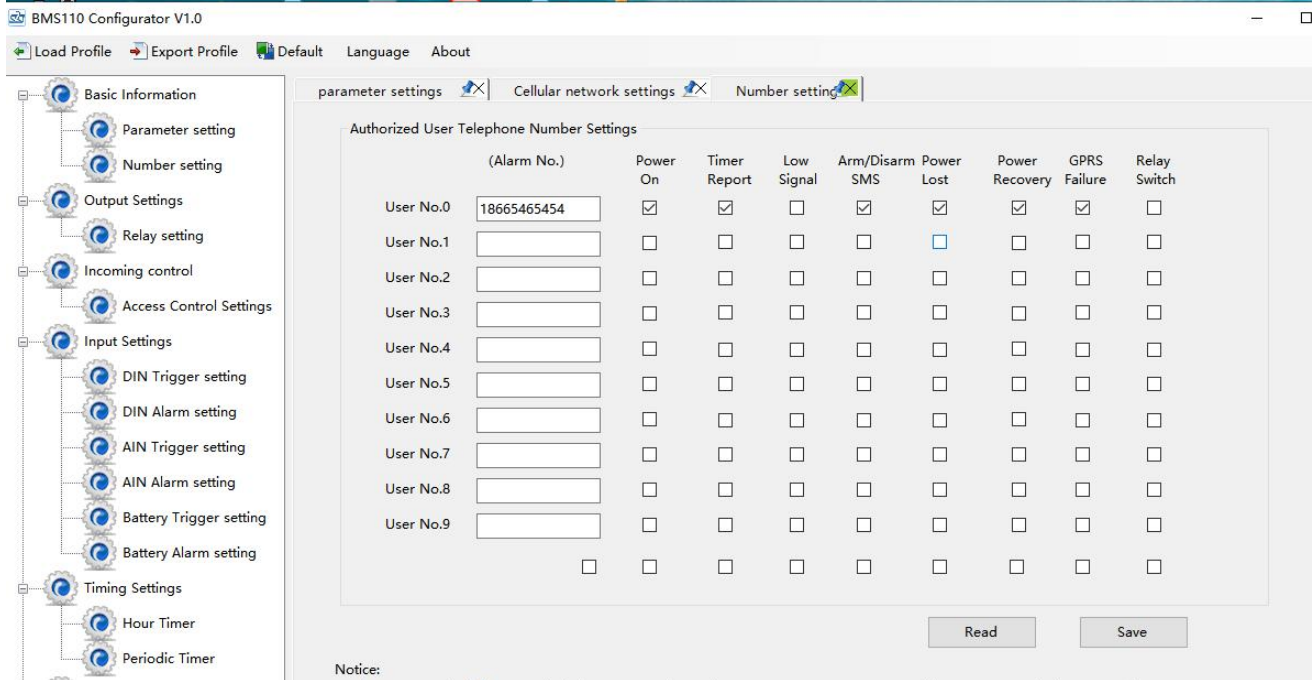

3. Turn off, turn the work mode switch to "Run" side, that is, install the SIM card, then turn it on. After the SIM mobile phone card registered the network about 1-2 minutes later, the mobile phone number used to receive the alarm will be received sms:the device turn on . At the same time, unplug the external power supply of the device, and the mobile phone number will be able to receive SMS : the external power is failure. Then connect the external power supply to the device, the mobile phone number will be able to receive sms: the device's external power supply is recovery. So far, the device communication verification is completed.

4.Enter the configuration page of the device again.Click the [read] button on the set page to read out the parameters set previously, otherwise it will be covered by the new parameters.

7.2 Device connect analog transducer

If the oil level sensor to be connected to the analog input AI0 outputs a 4-20mA signal, the measuring range of the oil level is 10~90CM. When the measured oil level is lower than 30CM for more than 60 seconds, an alarm is required, then the setting steps as follows:



1. Turn off the device and turn theAIN0 input type selection switch to the mA end, that is, the lower end.

2.Connect the oil level sensor to the port corresponding to AI0 through a wire. The following figure shows the wiring diagram:

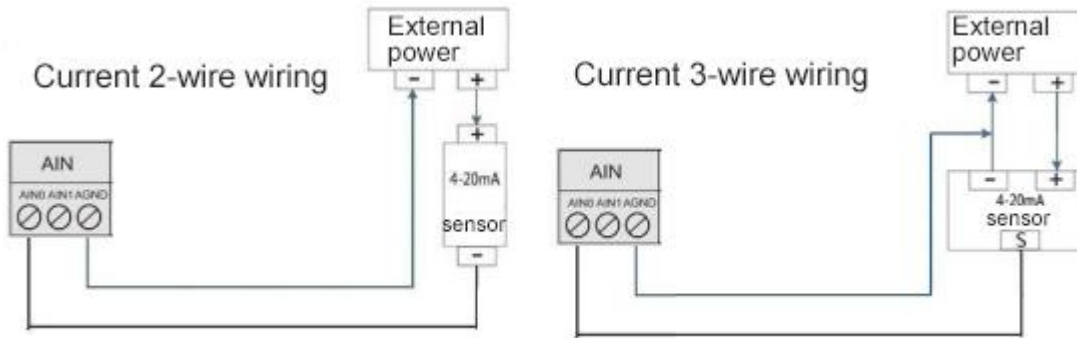

3. Complete the basic setting according to 7.1.

4. Enter the [AI trigger setting] page, set the input type to [4~20mA], fill in the high alarm content, low alarm content, fill in the maximum range: 90, the minimum range: 10, threshold low value: 30, confirm time: 60. If you need to restore the alarm reminder, you need to tick the reset alarm and fill in the corresponding content in the restore content box, Click the [save] button . As shown below:

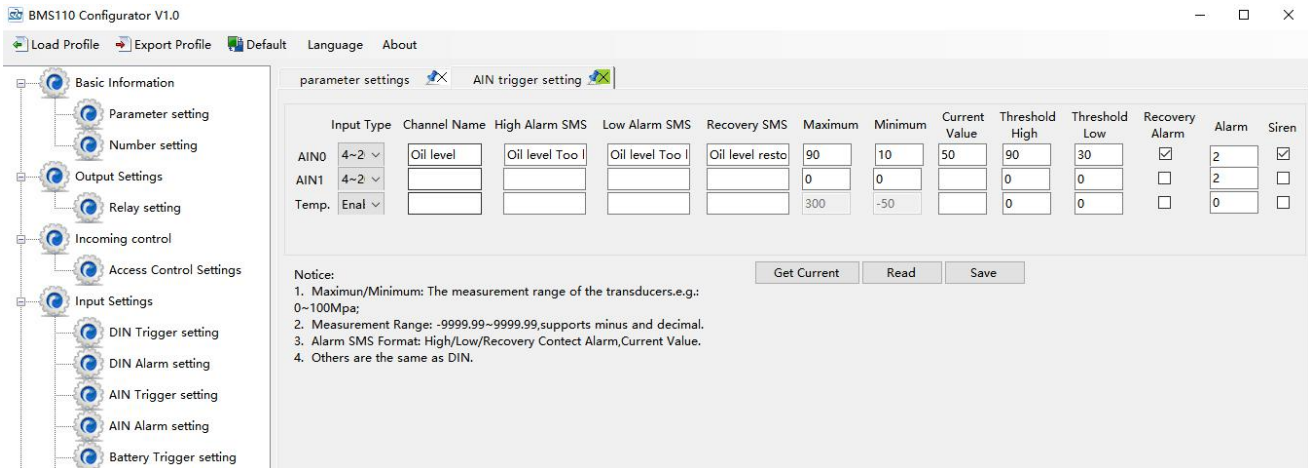

5. In the [AIN Alarm setting] page, tick the corresponding alarm number (all are ticked by default).

6. Then restart the device. At this time, when the device is turned on, the external power supply is powered off, the external power supply resumes normal power supply, and the oil level is low, the device will alarm according to the configuration parameters, and notify the alarm receiver via SMS or phone. If the network communication function is set, It will also transmit data to a remote server or cloud via GPRS/3G/4G network.

7.3 Automatic control applications

Scenario: When monitoring the battery pack voltage is too low, control the inverter to stop working to prevent battery damage;

Need to use: total voltage low limit alarm and 1 relay output, assuming the relay DOUT0 is used.

The setting method is as follows:

1. In the off state, connect the inverter stop working interface to the relay port.
2. Complete the basic settings according to 7.1.
3. Set the first relay in the [Relay Settings] page, where the output type is selected as [Used as a switch], the channel name can be: control inverter, and the closing time is set to 0, which means it has been closed. Other options need not be set, click the [write] button at the bottom. As shown below:

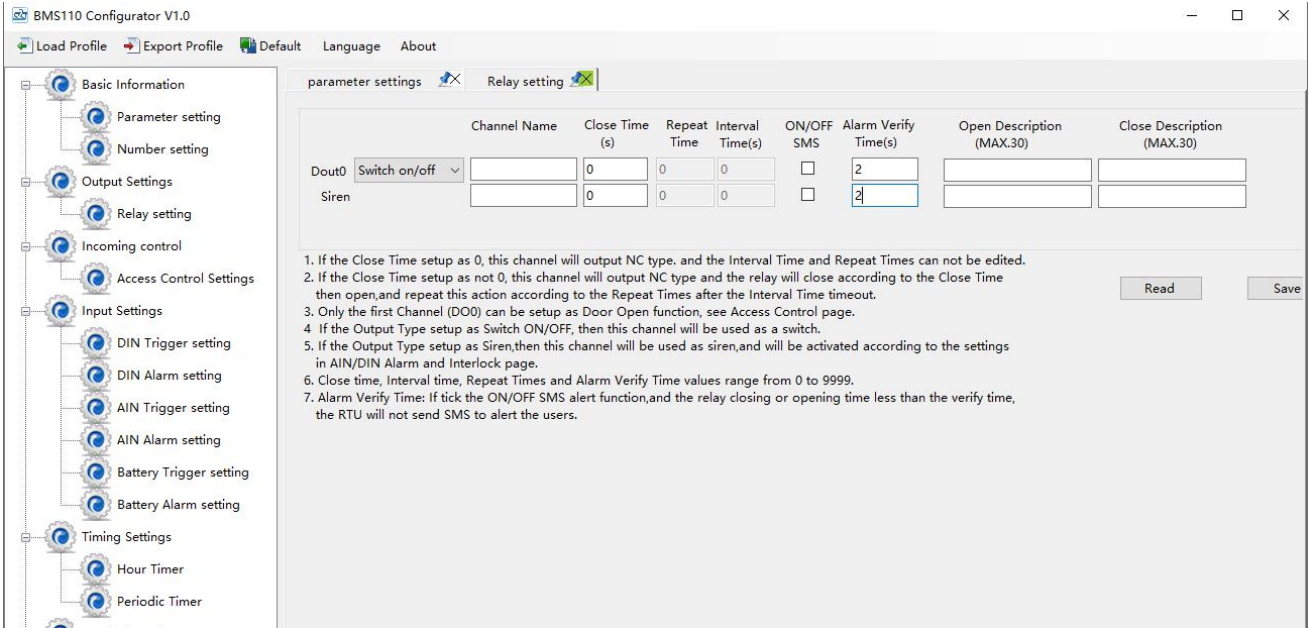

4. In the [Battery Trigger Settings] page, set the number of [Battery quantity], At the same time, set the corresponding SMS alarm content, set to 45 in the [Threshold high] and 20 in the [Threshold low]. The recovery alarm and confirmation time can be filled in as needed, and then click the [save] button. As shown below:

5. In the [Interlock Settings] page, select [Total Voltage Low Limit Alarm] for the event, select [Relay 0 Closed] for the action, and click the [Add] button to add this associated event to the device, which means When the total battery voltage is lower than 20V, the device will automatically close relay DOUT0, that is, stop the inverter; select [total voltage recovery] for the event, select [relay 0 off] for the action, and click the [Add] button to This associated event is added to the device, which means that when the total voltage returns to more than 20V, the device will automatically disconnect relay DOUT0, that is, the inverter is in a working mask. Click the [save] button on the lower side, as shown in the figure below:

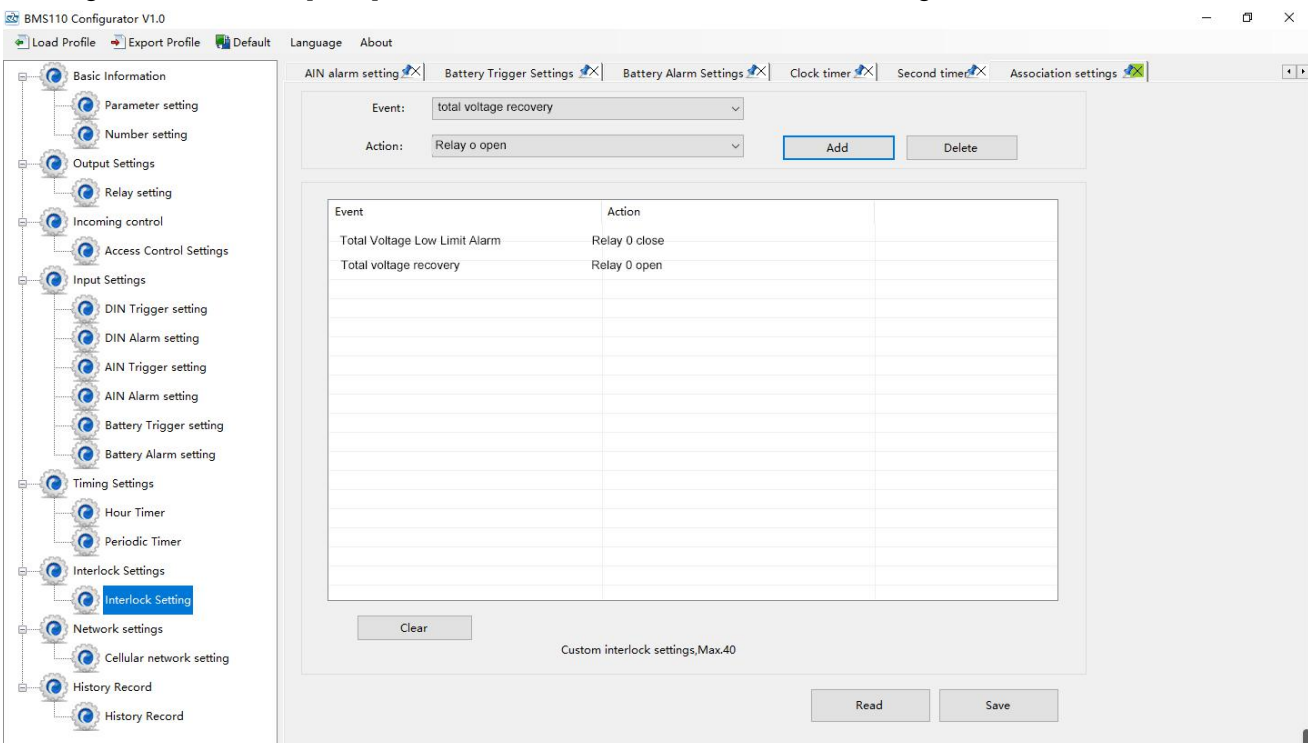

6. Then restart the device. At this time, when the device is turned on, the external power supply is powered off, the external power supply resumes normal power supply, and the temperature is over high or low, the

device will alarm according to the configuration parameters, and notify the alarm receiver via SMS or phone. If the network communication function is set, It will also transmit data to a remote server or cloud via GPRS/3G/4G network. At the same time, the inverter will be turned on or off automatically according to the high and low limits of the total battery voltage.

7.4 Connect to cloud platform configuration, WeChat push applications

7.4.1 Device connection cloud platform configuration

This device supports access to cloud platform or SCADA system through GPRS/3G/4G network. Users can choose private cloud platform and KingPigeon 3.0 cloud platform. This section introduces an example of accessing the cloud platform KPIIOT V3.0 as an example.

KPIIOT V3.0 cloud platform supports Modbus protocol, has configuration function, supports WeChat alarm function, powerful editable function is very popular with users. For more information about WeChat push and cloud platform configuration instructions, please refer to the KPIIOT V3.0 cloud platform configuration materials.

1) In the [Basic Parameter Setting] page, set the ID number of this device. In the Modbus RTU protocol, the range is 1~247, as shown in the figure below:

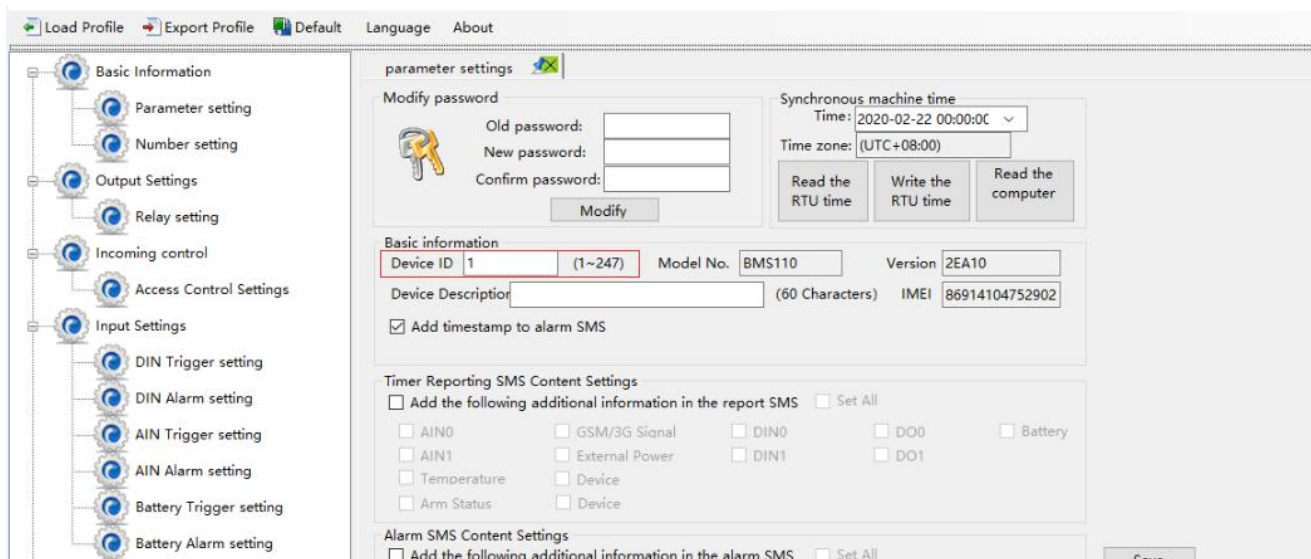

2) In the [Network Settings] page, set the network parameters as follows:

Click King Pigeon Cloud 3.0 platform, the software will automatically fill in the parameters that need to be set, just contact the sales customer service to provide the login message, and enter the location as shown below. And 3.0 cloud platform account and password.

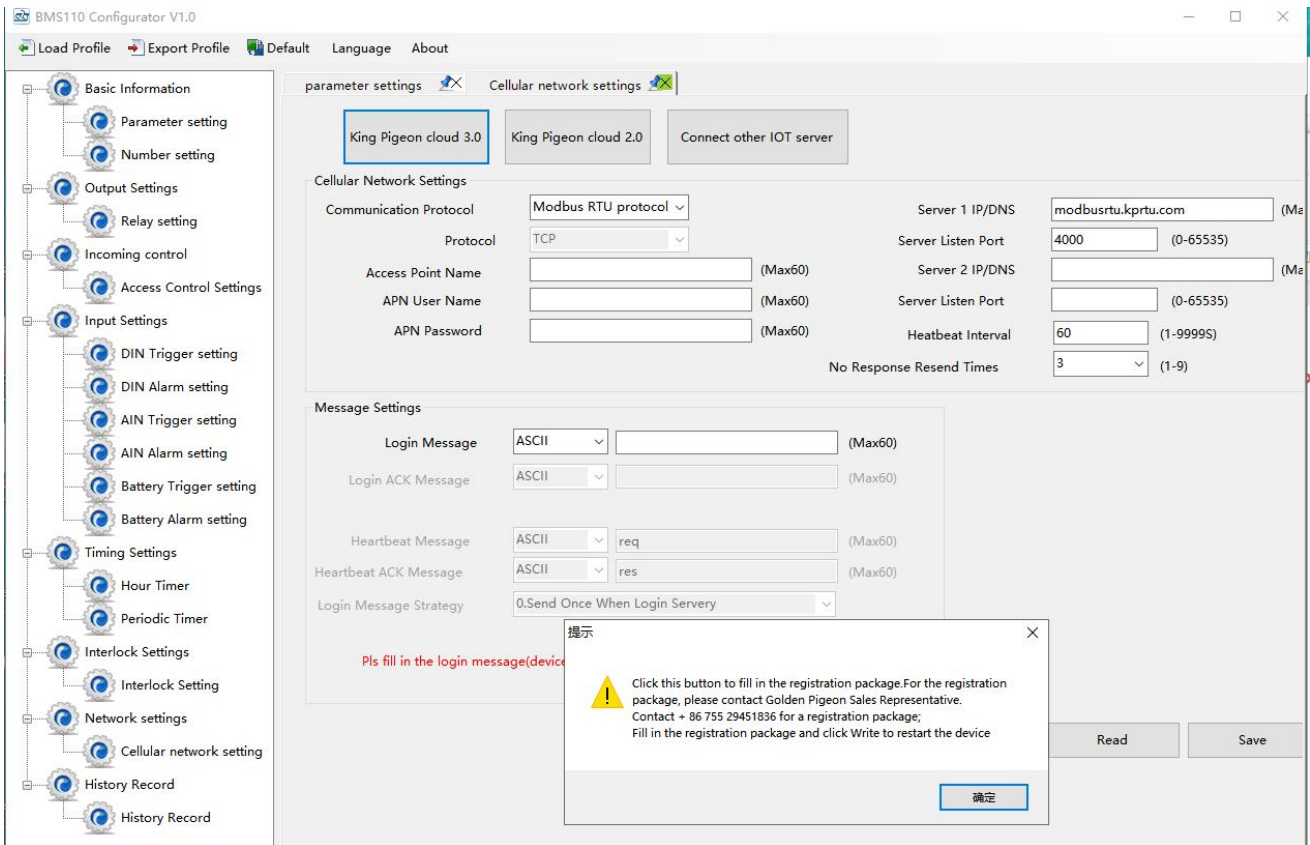

3) Click the [save] button , and turn off the device.

4) Turn on, push the power switch to the ON side, and the device will enter the working mode. At this time, the device can realize the functions of network acquisition and control of the local I/O, configuration, and WeChat push alarm information.

5) Enter modbusrtu.kpiiot.com in the computer browser and log in with the cloud platform account and password registered by the sales customer service. As shown below:

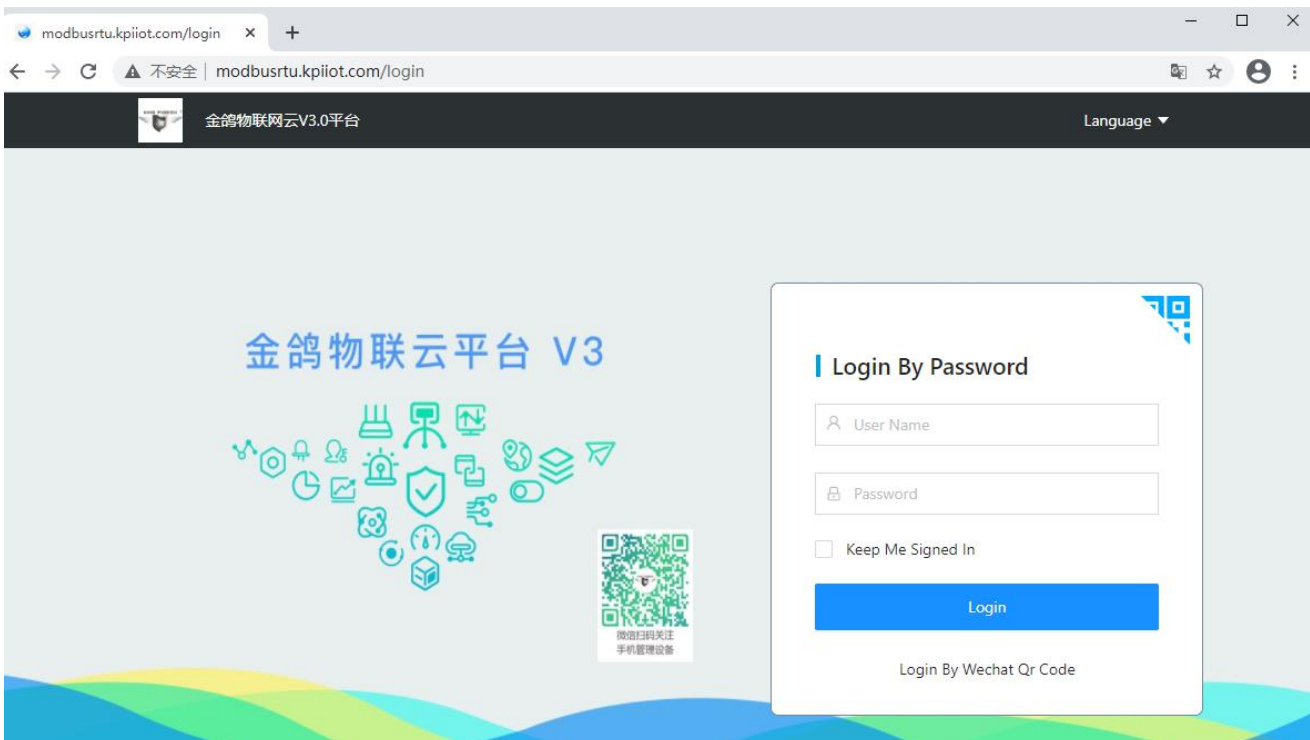

Click [Device Management]-[New Device]-respectively enter the device ID (login message), device name, Overtime Time (default is 300 seconds) of the device, select the device address on the map, and

then click OK.

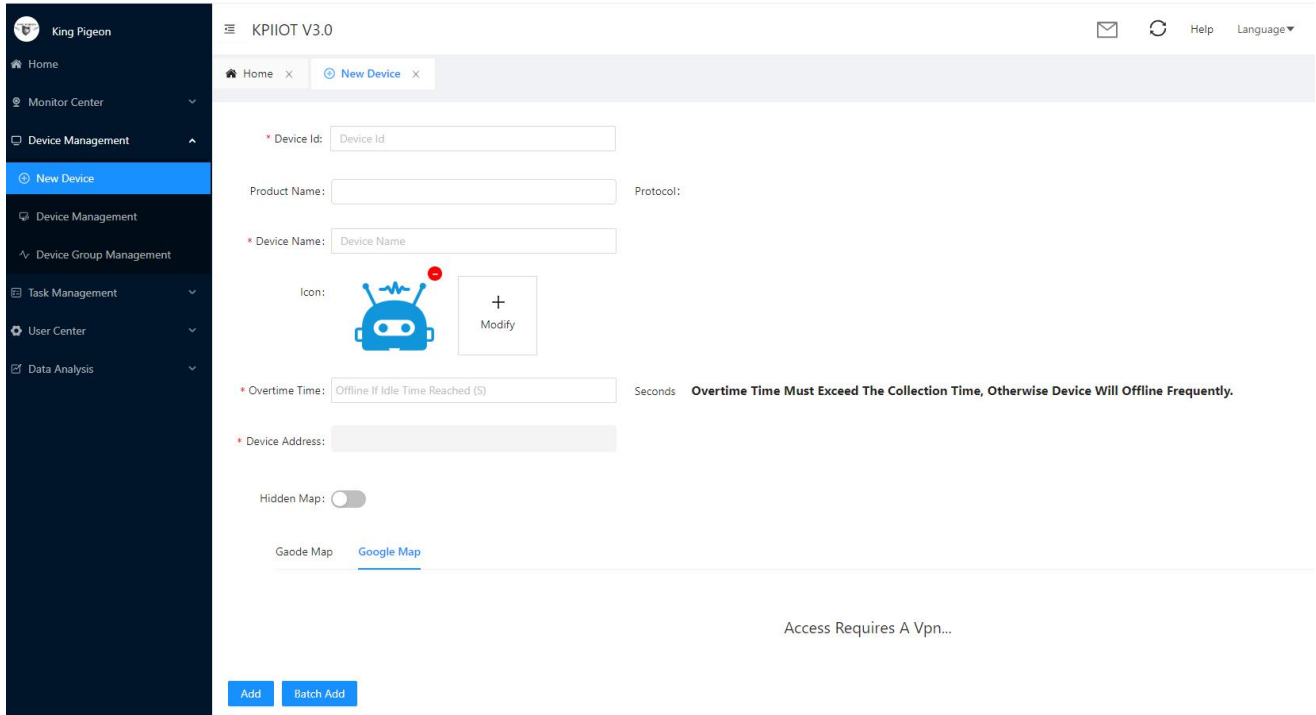

The cloud platform recognizes all data points of BMS110 by default. Then return to [Monitoring Center]-[Device List] to monitor the current value of each data point of BMS110 in real time.

7.4.2 WeChat push settings

1. Please follow the "King Pigeon Iot" WeChat official account, log in your account and password on the web page, and click on the "user center" in the user name, as shown below:

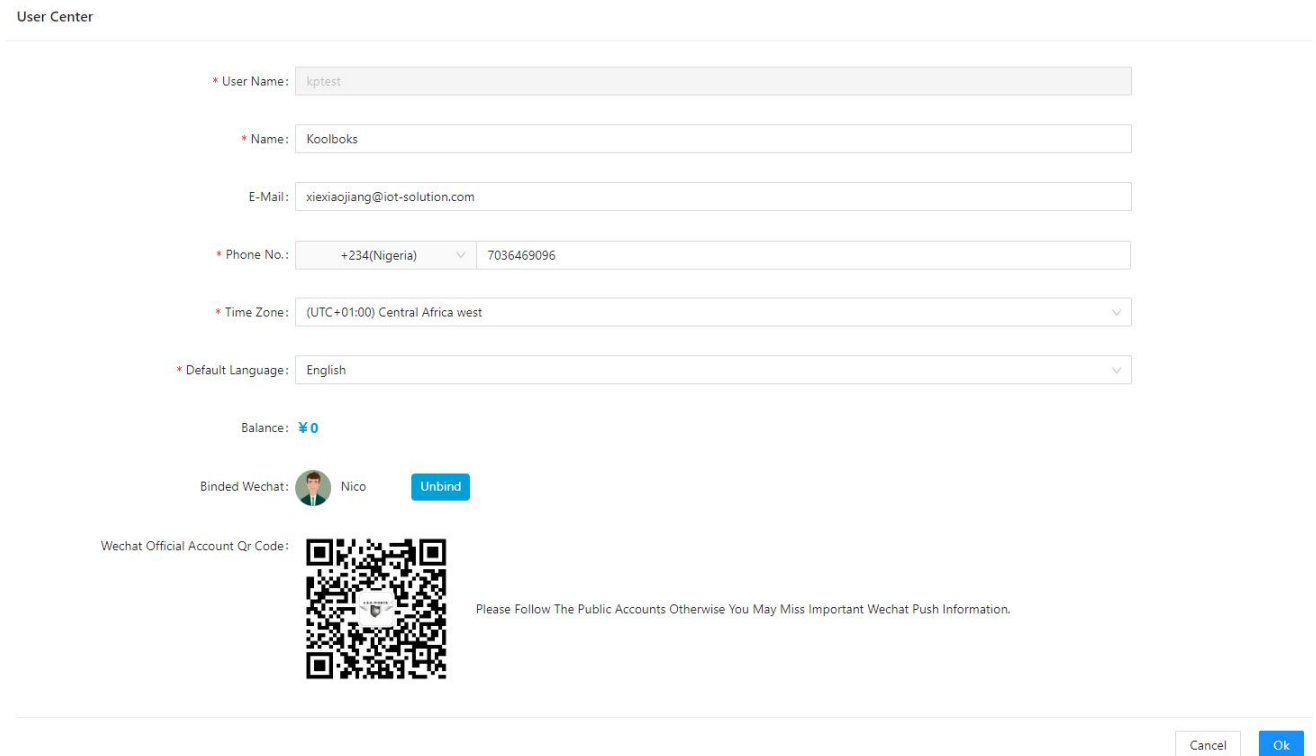

Scan "Wechat Official Account Qr Code".

2. After the follow-up is successful, open WeChat again and scan the QR code bound to WeChat, as

shown in the following figure:

* Name:

E-Mail:

* Phone No.:

* Time Zone:

* Default Language:

Balance: ¥0

Binding Wechat:



Scan Qr Code Binding

Wechat Official Account Qr Code:



Please Follow The Public Accounts Otherwise You May Miss Important Wech

3. Fill in your own cloud platform account and password in the page on the left as shown below, and click "bind"; the right image below is the interface after successful binding;

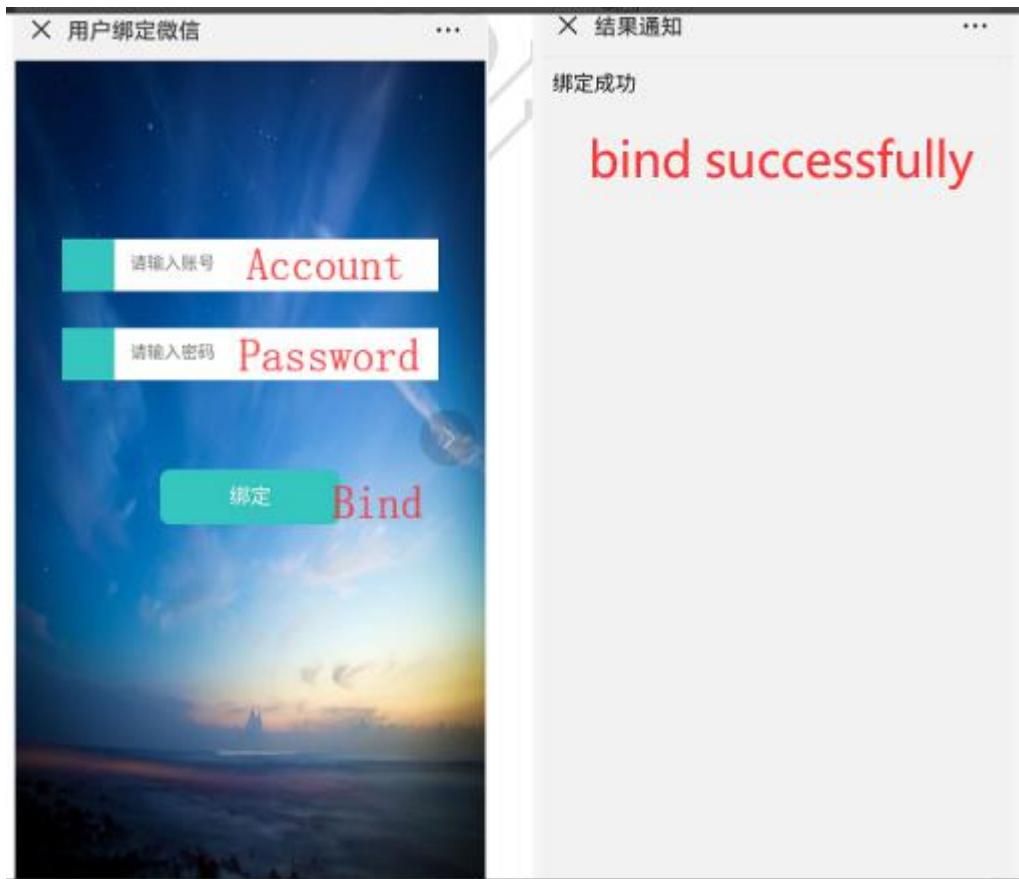

4. Log in on the web page, click on the user center, you can see the successfully bound WeChat, as shown below:

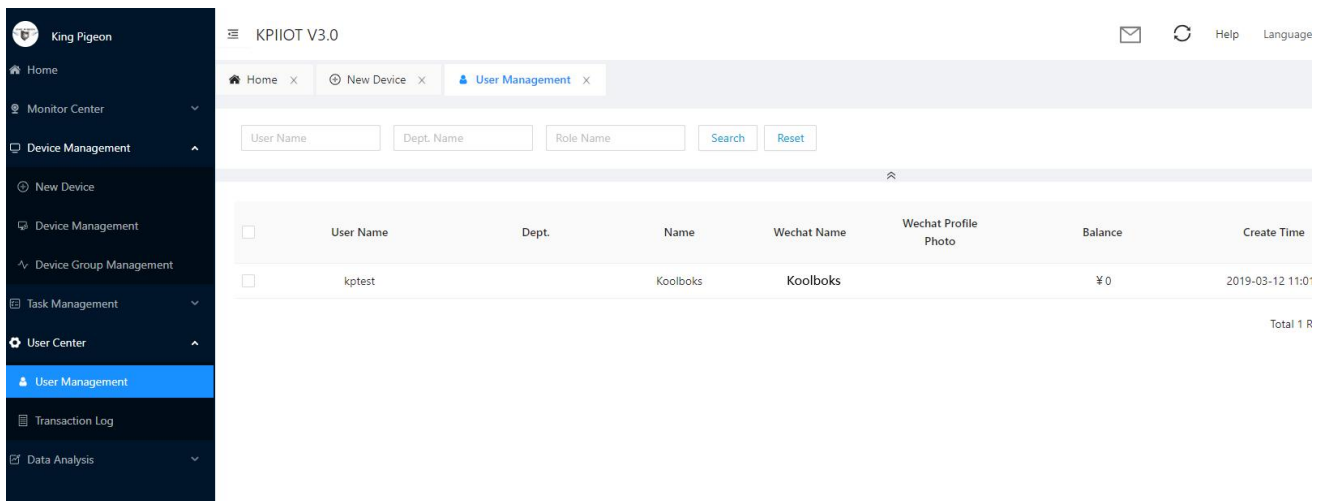

5. Click "Task Management"->"Trigger Management"->"New Trigger" on the web page, as shown in the page below, select "WeChat" in the alert mode, and select the account that has just been successfully bound to WeChat in the alert contact Contact, click submit



King Pigeon KPIIOT V3.0

Home x New Device x User Management x Trigger Management x New Trigger x

Enable/Disable:

* Device: Device

Select Data Point: Data Point

* Trigger Condition: Trigger Condition

Wechat Contact: Wechat Contact Billing Rules: ¥0/Wechat

Sms Contact: kptest Billing Rules: ¥0.1/Text Message

Email Contact: koolbok Billing Rules: ¥0/Email

Voice Contact: Email Contact Billing Rules: ¥0.2/Voice

App Contact: Voice Contact

Re-Notify Interval: 0 Seconds

* Forward Or Not: No Yes

6. When the created trigger reaches the alarm condition, an alarm will be triggered. WeChat will receive an alarm push, and the PC will also have an alarm display, as shown in the figure below (When the first alarm push is not confirmed, WeChat will Push again according to the re-alarm interval set when the trigger is created).

7. The WeChat terminal also supports online viewing of devices. Click "King Pigeon IOT" --- "Monitor", enter the account and password, and click login, you can see all the devices under the account, and you can operate the devices online and monitor data in real time

7.5 Modbus slave application

7.5.1 Read the device DO status

The DO register address of the relay provided by the machine belongs to the holding coil, address 0-1, see details "Appendix B local registers".

Master Send Data Format:

Send content	Bytes	Data (H:HEX)	Description
Device address	1	01H	01H device ID, range: 1-247, subject to the address set
Function code	1	01H	Read the holding coil with function code 01
Do register start address	2	00 00H	Range: 0000H-0001H
Number of read do registers	2	00 02H	Range: 0001H-0002H
16 CRC check	2	BD CBH	CRC0 CRC1 low byte first, high byte behind



Receiver Return Data Format:

send content	Bytes	Data (H:HEX)	Description
Device address	1	01H	01H device ID, consistent with the data issued
Function code	1	01H	Read holding coil
Return byte length	1	01H	Return data length
Return data	1	02H	Data returned
16 CRC check	2	90 48H	CRC0 CRC1 low byte first, high byte behind

Example: read two DO states with device address 1.

Sent by server: 01 01 00 00 02 BD CB

Among them:

01: device address

01: read relay DO function code

00 00: DO register start address

00 02: read 2 DO data continuously

BD CB: CRC verification

Device return: 01 01 01 01 90 48

Among them:

01: device address

01: read relay function code

01: return data length

02: The returned data, converted into binary: 0000 0010, the upper 6 bits 000000 are useless, and the lower 2 bits 01 correspond to Siren, DOUT0, 0 stands for open, 1 stands for close. The values are as follows:

siren	DOUT0 (relay output)
0	1
no output	close

90 48: CRC verification

If you want to read a certain DO status or certain DO statuses, you only need to modify the "DO Register Start Address" and "Read Register Number", and then recalculate the CRC. The returned data is analyzed as described above.

7.5.2 Control device DO status

Control device single Digital output:

Master Send Data Format:

Content	Bytes	Data (H:HEX)	Description
Device address	1	01H	01H device ID, Range: 1-247, according to setting address
Function code	1	05H	Write single holding coil with function code 05
DO register	2	00 00H	Range: 0000h-0003H



address			
Active	2	FF 00H	This value: FF 00H or 00 00H, FF 00H= Close relay, 00 00H= Open relay
16 CRC Verify	2	8C 3AH	CRC0 CRC1 low byte first, high byte behind

Receiver Return Data Format:

Content	Bytes	Data (H:HEX)	Description
Device address	1	01H	01H device ID, according to the data Master send
Function code	1	05H	Write single holding coil type, function code 05
Do register address	2	00 00H	Range: 0000h-0003H
Action performed	2	FF 00H	This value: FF 00H or 00 00H, FF 00H= Already actived close relay, 00 00H= Already actived open relay
16 CRC Verify	2	8C 3AH	CRC0 CRC1 low byte first, high byte behind

Example: Control relay DO0 close, then:

Server send: 01 05 00 00 FF 00 8C 3A

01H= Device address; 05H= Control single relay command; 00 00 H DO0= Address; FF 00H= DO0 close; 8C 3A H16 byte CRC verify.

Device answer: 01 05 00 00 FF 00 8C 3A

01H= Device address; 05H= Control single relay command; 00 00 H DO0= Address; FF 00H= ActiveDO0 close; 8C 3AH 16 byte CRC verify.

If single control other relay outputs, only need to change "DO Register Address" and "Active", calculate CRC verify again.

7.5.3 Read device DIN status:

Master Send Data Format:

Content	Bytes	Data (H:HEX)	Description
Device address	1	01H	01H device ID, range: 1-247, according to setting address
Function code	1	02H	Read input coil with function code 02
DI register start address	2	00 00H	Range: 0000h-0001h, corresponding toDI0-DI1
Read DIN Register Qty	2	00 02H	Range: 0001h-0002h, read the number of DI
16 CRC verify	2	F9 CBH	CRC0 CRC1 low byte first, high byte behind

Receiver Return Data Format:

Content	Bytes	Data (H:HEX)	Description
Device address	1	01H	01H device ID, according to setting address
Function code	1	02H	Read input coil



Return Bytes Qty	1	01H	Return data length
Return data	1	00H	Return DI data
16 CRC verify	2	A1 88H	CRC0 CRC1 low byte first, high byte behind

Example: query 2 local DI data at the same time, then:

Sent by server: 01 02 00 00 02 F9 CB

Among them:

01: device address

02: Inquiry DIN status

00 00: DI starting address

00 02: read 2 DIN States continuously

F9 CB: CRC verify

Device return: 01 02 01 00 A1 88

Among them:

01: equipment address

02: Inquiry DIN status

01: return data bytes

00: DI state, each bit represents a DI state, 00h is converted into binary: 0000 0000. From high position to low position, it corresponds to DI 1-DI0 state in turn, 0 means open, 1 means close.

DI1	DI0
0	0
OPEN	OPEN

A1 88: 16 bit CRC verify

If you want to query some di status, you only need to change "DI start address" and "read DI register number", and recalculate CRC verify.

7.5.4 Read AI, temperature , DI count value ,battery and external power value

Master Send Data Format:

Content	Bytes	Data (H:HEX)	Description
Device address	1	01H	01H deviceID, range: 1-247, according to setting address
Function code	1	04H	Read input register with function code 04
Register start address	2	00 00H	Register start address
Read Register Qty	2	00 1EH	Read 30 16 bit register addresses in total
16 CRC verify	2	70 02H	CRC0 CRC1 low byte first, high byte behind

Receiver Return Data Format:

Content	Bytes	Data (H:HEX)	Description
Device address	1	01H	01H device ID, according to setting address



Battery Management Alarm System BMS100

Function code	1	04H	Read input register
Returned bytes qty	1	3CH	Return data length
Return data	38	00 00 09 6E 00 00 14 89 04 C2 04 C2 04 C2 04 B9 12 FF 00 00 00 00 00 00 00 00 00 00 04 96 01 96 00 00 00 00 00 00 00 00 00 00 00 00 00 00 00 00 08 C6 00 00 00 00 00 70 00 00 00 08H	Data values returned
16 CRC verify	2	0A 5DH	CRC0 CRC1 low byte first, high byte behind

Example: Inquiry device AIN, DIN0 count value, temperature, battery voltage, external power voltage at the same time, then:

Server send: 01 04 00 00 00 1E 70 02

01= Device address; 04= Read input register value; 00 00: Starting address; 00 1E= Serial reading 28 input register value; 70 02 CRC verify.

Device answer: 01 04 3C 00 00 09 6E 00 00 14 89 04 C2 04 C2 04 C2 04 B9 12 FF 00 00 00 00 00 00 00 00 04 96 01 96 00 00 00 00 00 00 00 00 00 00 08 C6 00 00 00 00 00 70 00 00 00 08 0A 5D

01= Device address; 04= Read input register value; 3C: return bytes data 00 00 09 6E 00 00 14 89 04 C2 04 C2 04 C2 04 B9 12 FF 00 00 00 00 00 00 00 00 00 00 04 96 01 96 00 00 00 00 00 00 00 00 00 00 00 00 00 00 08: returned data, the details are as follows:

Item	AI0	AI1	Bat1	Bat2	Bat3	Bat4	Bat
Data receive	00 00 09 6E	00 00 14 89	04 C2	04 C2	04 C2	04 B9	12 FF
Decimal value	2414	5257	1218	1218	1218	1209	4863
Real value	24.14	52.57	12.18V	12.18V	12.18V	12.09V	48.63V

Item	Reserved address	External power supply voltage	Internal battery voltage	Reserved address	Temperature value	Reserved address	DI0 count value	DI1 count value
Data receive	--	04 96	01 96	--	08 C6	--	00 00 00 70	00 00 00 08
Decimal value	--	1174	406	--	2246	--	112	8
Real value	--	11.74V	4.06V	--	22.46°C	--	112	8

0A 5D: CRC verify



8. Update Firmware

This device adopts modular structure design. When the operator's network is upgraded, the whole hardware does not need to be replaced. If the communication module inside the equipment is replaced directly, the equipment can be easily and quickly upgraded from GSM network to 3G network or from 3G network to 4G network.

This device supports direct firmware upgrade via USB port. If you need to upgrade firmware for any new requirements, please contact us.

9. Warranty

- 1) This equipment from the date of purchase, for a period of one year, there are any material or quality problems, free maintenance.
- 2) This one-year warranty does not include any product failure caused by human damage, improper operation, etc.

10. Technical support

Shenzhen King Pigeon Technology Co., Ltd

Tel: 0755-29451836

website: <http://www.iot-solution.com>

11. Appendix A SMS Command List

1) Modify Password

Operation	Command	Return
Set up	Old password + P + new password ①	This is the new password. Please keep it in mind.

① Note: the default password is 1234, and the new password requires 4 digits.

2) Arm/Disarm

Operation	Command	Return
Arm	password+AA	Armed
Disarm	password+BB	Disarmed

3) Setting RTU time

Operation	Command	Return
Set up	Password + Dxxxx-xx-xxTxx:xx:xxWxx	xxxx(Y)XX(M)XX(D)xx(H)X(



	Example: 1234D2015-05-22T15:20:30W01, W01 for Monday, W07 for Sunday	M)xx(W)
--	--	---------

4) Inquiry device status

Operation	Command	Return
inquiry	Password + EE	Armed/Disarmed Model: Version: IMEI: GSM Signal Value: External DC Power Goes OFF/ON

5) Set user number

Operation	Command	Return
set up	password + A + series number + T + tel number. Serial number: 0-9	Telx: ---
Inquiry	Password + A	Return all numbers
Delete	Password + A + serial number	Return serial numbers 0 ~ 4 and 5 ~ 9

6) Authority User Number to access control:

authorized number can dial to disarm and open the door

After setting, the user number will open the door within the authorized time

Operation	Command	Return
set up	Specified access control time: password + B + series number + S + start time + E + endtime Always can access control: password + B + series number + P Notice: Time format is 201505231230, stands for year, month, date, hour, minute	Tel1: --- Tel2: --- Tel3: 13570810254 Tel4: --- Tel5: ---
inquiry	Password + B	Return all authorization numbers
delete	Password + B + serial number	Return all authorization numbers

7) Set daily report time

Operation	Command	Return
Setup	password + DR + series number + T + time Notice: Series number = 0~9, e.g.: 1234DR1T12:30	Daily SMS Report at: xx:xx
Inquiry	password + DR	
Delete	password + DRDEL	

8) Digital input



Operation	Command	Return
Inquiry Status	password+DINE	DIN1:Open/Close DIN2: Open/Close -----

9) Analog input

Operation	Command	Return
Set Threshold value	set up password+AINR+channel number+Lxxx+Hxxx	AINx: Low:xxx,High:xxx.
	inquiry password+AINR+ Serial number	AINx: Low:xxx, High:xxx. AINy: Low:xxx, High:xxx.
	delete Password + AINR + serial number + DEL	
Sensor range	set up password+AINM+ channel number+Lxxx+Hxxx	AIX: minimum XXX, maximum XXX. AIY: minimum XXX, maximum XXX.
	inquiry password+AINM+ Serial number	AIX: minimum XXX, maximum XXX. AIY: minimum XXX, maximum XXX.
	delete Password + AINM + Serial number + DEL	
Inquiry current value	password+AINE+Serial number	AINx: xxxx , 【Normal/Higher/Lower】
Inquiry All AIN Current Value	Password + AINE	AIN1: xxxx , 【Normal/Higher/Lower】 AIN2: xxxx , 【Normal/Higher/Lower】 ----

10) Control relay

	SMS Command	Return SMS Content
Set DO Name	password+DO+channel number+T	DOx:xxxx
Inquiry DO Name	password+DO+ channel number<n timer>	
Delete DO Name	password+DO+ channel number+DEL	
Switch ON(Close)	password+DOC+ channel number<n timer>	DOx: ON DOy:ON
Switch OFF(Open)	password+DOO+ channel number<n timer>	DOx: OFF DOy:OFF
Inquiry DO Current Status	password+DOE+ channel number<n timer>	DOx: ON/OFF DOy:ON/OFF



Inquiry all DO Current Status	password+DOE	DO1: ON/OFF DO2:ON/OFF ---
Time Switch ON (Close)	password+DOLC+ channel number<nnnn>	
Set Pulse Output time	password+DOT+xxx	Pulse Output Time:xxxS
Inquiry pulse output time	password+DOT	Pulse Output Time:xxxS
Pulse Ouput	password+DOP+channel number<nnnn>	No SMS Return

11)Set up server (cellular network)

Operation	Command	Return
set up	Password + IP + IP address + P + port number	The server: Port:
inquiry	Password + IP	
delete	Password + IPDEL	

12)Setting cellular network parameters

Operation	Command	Return
set up	Password + AP +APN+# + user name +# + user password	APN: user name: password:
inquiry	Password + AP	
delete	Password + APDEL	

13)GPRS Online

Operation	Command	Return
Control online	Password + GPRSonline	GPRS always on

14)Historical records

Operation	Command	Return
delete	Password + HISDEL	Delete all history

15)Set pulse counter

Operation	Command	Return
Clearing	Password + DIN + serial number + CLR	Clear successfully
query	Password + PR	Current counter value: XXX

Note: "serial number" is 0 ~ , corresponding to DI0 ~ 1 pulse counter

12. Appendix B Modbus Register Address

1) Holding coil type, readable and writable, function code 01/05/15.

Register address		Data name	Data type	Description
Modbus Register	PLC or configuratio			



Address(Decimal)	n address (Decimal)			
0	0001	RTU relay	Bool	1:close
1	0002	Siren	Bool	0:open

2) Input coil type, read-only, function code 02.

Register address		Data name	Data type	Description
Modbus Register Address(Decimal)	PLC or configuration address (Decimal)			
0	10001	RTU DI0	Bool	Dry contact Short circuit: logic 1
1	10002	RTU DI1	Bool	Open circuit: logic 0 Wet contact 0-0.5v: logic 1 3-30V: logic 0

3) Input register type, read-only, function code 04.

Register address		Data name	Data type	®Description
Modbus Register Address(Decimal)	PLC or configuration address (Decimal)			
0~1	30001~30002	RTU AIN 0	32bit int	Y=X/100
2~3	30003~30004	RTU AIN 1	32bit int	Y=X/100
4	30005	Battery 1	16bit uint	Y=X/100
5	30006	Battery 2	16bit uint	Y=X/100
6	30007	Battery 3	16bit uint	Y=X/100
7	30008	Battery 4	16bit uint	Y=X/100
8	30009	Total battery voltage	16bit uint	Y=X/100
9-13	30010~30014	Reserved, not available	---	---
14	30015	Power voltage	16bit uint	Y=X/100
15	30016	Internal battery voltage	16bit int	Y=X/100
16-23	30017~30024	Reserved, not available	---	---
24	30025	Temperature	16bit uint	Y=X/100
25	30026	Reserved, not available	---	---
26~27	30027~30028	DIN0 Count Value	32bit uint	Enable when as counter mode
28~29	30029~30030	DIN1 Count Value	32bit uint	Enable when as counter mode

Note 1

In the description, the variables are defined as follows:

Y: True value

X: The register in which the value is stored

"Y = X/100" stands for "Real value = value stored in current register/100"

4) Read and write holding Coil, function code 03/06/16.

Register address		Data name	Data type	Description
Modbus Register Address (Decimal)	PLC or configuration address (Decimal)			
253 (bit0)	40254 (bit0)	DI0 clear	Bool	Write 1 to clear the DI0 count
253 (bit1)	40254 (bit1)	DI1 clear	Bool	Write 1 to clear the di1 count
12 (bit0)	40013 (bit0)	Arm/disarm status	Bool	0 is disarm,1 is arm

13. Appendix D MQTT Application

MQTT is a client-server based message publish/subscribe transport protocol. The MQTT protocol is lightweight, simple, open, and easy to implement, and these features make it very versatile. In many cases, including restricted environments such as machine to machine (M2M) communication and the Internet of Things (IoT). It is widely used in satellite link communication sensors, occasionally dialed medical devices, smart homes, and some miniaturized devices. The MQTT protocol runs on TCP/IP or other network protocols, providing ordered, lossless, two-way connectivity.

The following example uses access to King Pigeon cloud 2.0 platform www.my-m2m as an example.

MQTT Principle

There are three identities in the MQTT protocol: Publisher (Publish), Broker (Server), Subscriber (Subscribe). Among them, the publisher and subscriber of the message are both clients, the message broker is the server, and the message publisher can be the subscriber at the same time.

Devices use MQTT communication through only two steps.

1. Devices publish the Topic through broker;
2. Users can create a account on broker to subscribe to the device to achieve monitoring

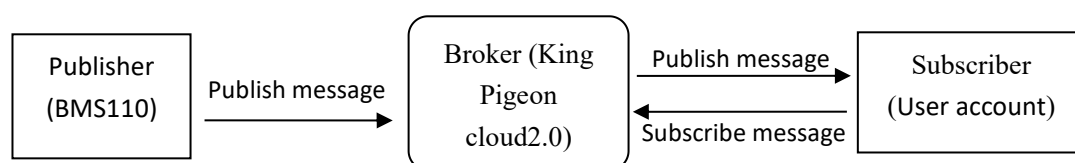

(uploads data to Broker)

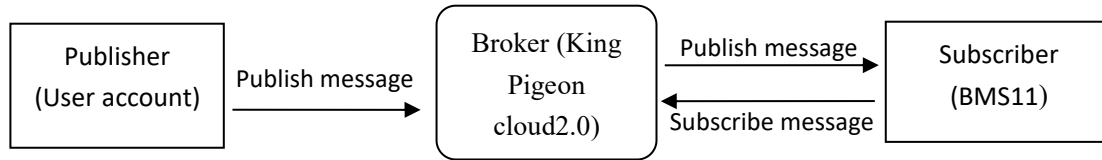

Client configuration:

- 1) Communication protocol: MQTT protocol
- 2) Server IP domain name: King Pigeon Cloud 2.0 default: mqtt.dtuip.com
- 3) Port: Broker Server Port number (King Pigeon Cloud 2.0 default: 1883) .
- 4) Subscription topic: Client subscribe topic (King Pigeon cloud 2.0 default: serial number/ +)
- 5) Publish topic: Device publish data topic (King Pigeon cloud 2.0 default: serial number/ +).
- 6) Mqtt client ID: the unique identification, which can be serial number, device ID, or IMEI code (KingPigeon Cloud 2.0 default is serial number)
- 7) Mqtt user name: Device's account on the broker server (King Pigeon Cloud 2.0 default is MQTT)
- 8) Mqtt password: Password of device's account on the broker server (King Pigeon Cloud 2.0 default is MQTTPW)

After the configuration is completed, the client will initiate a connection to the server:

Connect: the client sends a connect message request to the server;

Connack: the server responds to a connack confirmation message, indicating that the connection is successful;

After the client establishes a connection, it is a long connection, and the client can publish or subscribe messages on the server;

Take devices and customers' mobile phones as clients

After the device publishes the topic on the proxy server, customers can view the data through subscription. That is, the device is the publisher, and the customer's mobile phone is the subscriber.

Similarly, users can control the device by publishing topics through the mqtt server. That is, the



user is the publisher and the device is the subscriber.

Payload data format in equipment release message

Publish Topic: MQTT client ID (filled in configuration software)

```
{
  "sensorDatas":
  [
    {
      "flag": "DI1",           //Read write identification
      "switcher": 1          //Data type and value
    },
    {
      "flag": "AI1",
      "value": 10.00
    }
  ],
  "time": "1591841863",
  //Time stamp (When power on,first time connection no time stamp, later
  //connections have time stamp)

  "state": "alarm",
  //Alarm and recovery identification (only for alarm or recovery data, but
  //not timely report)

  "retransmit": "enable"
  //Historical data identification (only for re-transmission of historical data, but
  //not for real-time data)
}
```

Note:

Read / write identifier: the character is "flag", followed by "read / write ID representing IO data point"

Data type and value: it can be divided into:

1. Switch data: the character is "switcher", followed by "0" or "1" (0 for open, 1 for closed)
2. Numerical data: the character is "value", followed by "specific value"

Time identification: the character is "time", followed by "specific reporting time stamp"

Alarm and recovery identification: the character is "state", followed by "alarm" or "recovery" (alarm represents alarm data and recovery represents recovery data)

Historical data identifier: character "retransmit", followed by "enable"

The data collected during the network disconnection will be temporarily stored in the device, and will be redistributed when the network is restored. The "retransmit" field is used to identify the historical data. (it is necessary to check enable mqtt data supplementary transmission function in the configuration software).

Payload data format in device subscription message

(The topic of the King Pigeon 2.0 platform downstream publish message is called "device serial number/sensor ID", so the device subscribe topic needs to add the wildcard "/" in order to receive the data sent by the platform to achieve control) Subscribe topic: device



serial number /+(corresponding to the data filled in the subscribe topic item on the configuration software)

```

{
  "sensorDatas":
  [
    {
      "sensorsId": 211267, //Platform sensor ID
      "switcher":1,      //Data type and value
      "flag":"DO1"      //Read write identification
    }
  ],
  "down":"down"      Platform downlink message identification
}

```

Note:

Platform sensor ID: character is "sensorsID", followed by ID number (ID is automatically generated by platform)

Data type and value: it can be divided into:

1. Switch data: the character is "switcher", followed by "0" or "1" (0 for open, 1 for closed)
2. Numerical data: the character is "value", followed by "specific value"

Read / write identifier: the character is "flag", followed by "read / write ID representing IO data point"

Platform downlink message identification: the character is "down", followed by "down", which means that this is the platform downlink data.

Device I/O data point read and write flag

Data name	Read write flag	Data type	Description
Relay output	DO0	Switcher	0 is open, 1 is closed
Siren	SIREN	Switcher	0 is open, 1 is closed
DI0	DI0	Switcher	0 is open, 1 is closed
DI1	DI1	Switcher	0 is open, 1 is closed
DI0 pulse count value	COUNT	Value	True value = original value,integer
DI1 pulse count value	COUNT1	Value	True value = original value,integer
AIN0	AI0	Value	True value = original value,With two decimals
AIN1	AI1	Value	True value = original value,With two decimals
Temperature	TEMP	Value	True value = original value,With two decimals
Battery 1 voltage	BAT1	Value	True value = original value,With two decimals
Battery 2 voltage	BAT2	Value	True value = original value,With two decimals
Battery 3 voltage	BAT3	Value	True value = original value,With two decimals



Battery 4 voltage	BAT4	Value	True value = original value,With two decimals
Battery total voltage	BAT	Value	True value = original value,With two decimals
Power supply voltage	EXTPWR	Value	True value = original value,With two decimals

The End!

Any questions please help to contact us feel free.

[Http://www.IOT-Solution.com](http://www.IOT-Solution.com)